

Fourth Generation 2 x 60A or 1 x 120A Brushless DC Motor Controller

**CANopen****EtherCAT**

Roboteq's FBLG2360T is a features-packed, low-voltage, high-current, dual or single channel controller for brushless DC motors. It is a direct replacement for the company's popular FBL2360, using a 4th generation processor and implementing many performance, algorithmic, and other qualitative enhancements. The controller can be commanded via serial, USB, Analog or Pulse signals. Multiple controllers can be networked over a low-cost, twisted pair CANbus network. The controller can be ordered with Ethernet, EtherCAT for high speed robotics systems.

The FBLG2360T uses the latest motion control technology, such as field-oriented control (FOC), acceleration/velocity Feedforward, and fast loop frequency to deliver quick and precise motion control in speed, torque or position modes. Numerous safety features, including Safe Torque Off (STO) are incorporated into the controller to ensure reliable and safe operation. For mobile robot applications, the controller's two motor channels can either be operated independently or mixed to move and steer a vehicle

Numerous safety features are incorporated into the controller, including Safe Torque Off (STO). The controller's operation can be extensively automated and customized using Basic Language scripts. The controller can be configured, monitored and tuned in real-time using a Roboteq's free PC utility. The controller can also be reprogrammed in the field with the latest features by downloading new operating software from Roboteq.

Applications

- Automatic Guided Vehicles
- Small Electric Vehicles, Electric Bikes
- Terrestrial and Underwater Robotic Vehicles
- Multi-Axis Robot Arms
- Factory Automation
- Telepresence Systems

Key Features

- USB, Serial, 0-5V Analog, or Pulse (RC radio) command modes
- RS232 and RS485 serial ports
- MODBUS ASCII & RTU Support over RS232 or RS485
- CAN bus up to 1 Mbit/s. Multi-Protocol support
 - CANOpen DS402
 - RoboCAN Meshed Network
 - RawCAN Customizable to Any Protocol
- Optional EtherCAT Interface CANOpen over EtherCAT (CoE)
- Auto switch between Serial, USB, CAN, fieldbus, Analog, or Pulse based on user-defined priority
- Built-in dual 3-phase high-power drivers for two brushless DC motors
- 2x60A Max, 2x40A continuous Current with I2T protection algorithm
- Output channels can be paralleled in order to drive a single motor at up to 120A
- Programmable current limit up to 60A (120A on single channel version) per motor for protecting controller, motor, wiring and battery.
- Supports Surface Permanent Magnet (SPM) motors or Internal Permanent Magnet (IPM) motors
- 97% or better typical Efficiency
- Multiple Motor Operating mode
 - Trapezoidal with Hall Sensors
 - Sinusoidal with Hall+Encoder
 - Sinusoidal with Encoders
 - Sinusoidal with Hall Sensors
 - Sinusoidal with Absolute Encoder
- Support for absolute angle encoders
 - Sin/Cos analog
 - SSI (single-turn and multi-turn)
 - Resolver

- Field Oriented Control in Sinusoidal modes
- Automatic Field Weakening for maximizing motor speed and torque
- Full forward & reverse motor control. Four quadrant operation. Supports regeneration
- Operates from a single 12V-60V power source
- STO - Safe Torque Off (Certification Pending)
- Separate connector for Hall Sensors
- Accurate speed and Odometry measurement using Hall Sensor or Encoder data
- Up to 8 Analog Inputs for use as command and/or feedback
- Up to 8 Pulse Length, Duty Cycle or Frequency Inputs for use as command and/or feedback
- Up to 10 Digital Inputs for use as Deadman Switch, Limit Switch, Emergency stop or user inputs
- Inputs for up to 2 Quadrature Encoders
- 4 general purpose 24V, 1.5A output for brake release or accessories
- Built-in Basic-like scripting language. Execution speed up to 100000 lines per second
- Selectable min, max, center and dead band in Pulse and Analog modes
- Selectable exponentiation factors for each command inputs
- Trigger action if Analog, Pulse or Hall counter capture are outside user selectable range (soft limit switches)
- Open loop speed control operation
- Closed loop speed, position and/or torque control
- Closed loop position control with encoder, hall sensors, analog or pulse/frequency feedback
- Cascaded Speed, Position, Torque PID loops
- High-Performance 16kHz Current Control loop
- Automatic Tuning of Torque, Speed and Position loops
- Automatic Motor Characterization
- Advanced performance optimization algorithms (Anti-cogging, notch filter, Decoupling control, ...)
- Support for 10 KOhm NTC temperature sensors through analog inputs (requires an external 10 KOhm pull-up resistor)
- Built-in Battery Voltage and Temperature sensors
- Optional backup power input for powering safely the controller if the main motor batteries are discharged
- Power Control wire for turning On or Off the controller from external microcomputer or switch
- No consumption by output stage when motors stopped
- Regulated 5V output for powering RC radio, RF Modem, sensors or microcomputer
- Separate Programmable acceleration and deceleration for each motor
- Ultra-efficient 2.5 mOhm ON resistance MOSFETs (1.25 mOhm on Single Channel)
- Stall detection and selectable triggered action if Amps is outside user-selected range
- Short circuit protection
- Overvoltage and Undervoltage protection
- Watchdog for automatic motor shutdown in case of command loss
- Overtemperature protection
- Diagnostic LED
- Efficient heat sinking. Operates without a fan in most applications.
- IP40 case protection rating
- Power wiring 0.25" Faston tabs
- 5.5" (139.7mm) L, 5.5" W (139.7mm), 1.0" (25mm) H
- -40oC to +85o C operating environment
- 1 lbs (500g)
- Easy configuration, tuning and monitory using provided PC utility
- Field upgradeable software for installing latest features via the Internet

Orderable Product References

Reference	Number of Channels	Amps/Channel	Volts	Ethernet
FBLG2360T	2	60	60	No
FBLG2360TS	1	120	60	No
FBLG2360TC	2	60	60	EtherCAT
FBLG2360TCS	1	120	60	EtherCAT
FBLG2360TE	2	60	60	Yes
FBLG2360TES	1	120	60	Yes

Warning

A dangerous uncontrolled motor runaway condition can occur due to various reasons, including, but not limited to: command or feedback wiring failure, configuration errors, faulty firmware, errors in user scripts or programs, or controller hardware failure.

Users must be aware that such failures can occur and must ensure the safety of their system under all conditions. Roboteq will not be held liable for any damage or injury resulting from product misuse or failure.

Important Note

All products are not serviceable. If damage is suspected, the item must be replaced rather than repaired.

Attempting to service or repair the product voids any existing warranty and may pose safety risks.

Consult customer support for more information on replacements.

Power Terminals Identifications and Connection

Power connections are made by means of faston tabs located at the back of the controller.

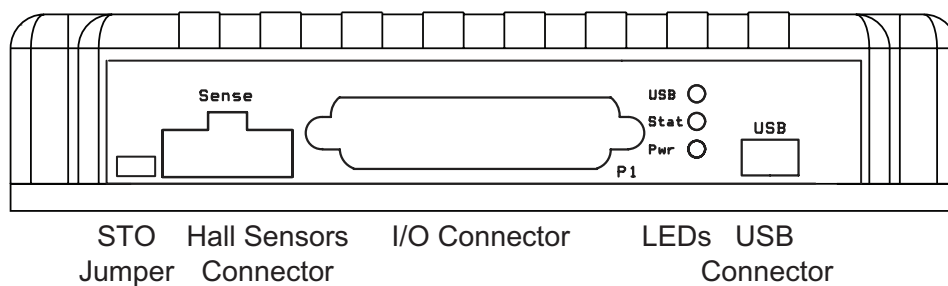

FIGURE 1. FBLG2360T front view

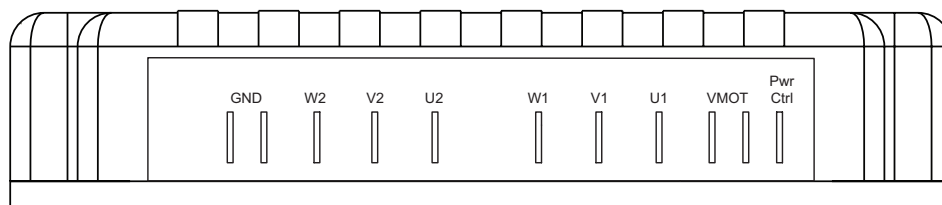

FIGURE 2. FBLG2360T rear view

The diagram below shows how to wire the controller and how to turn power On and Off.

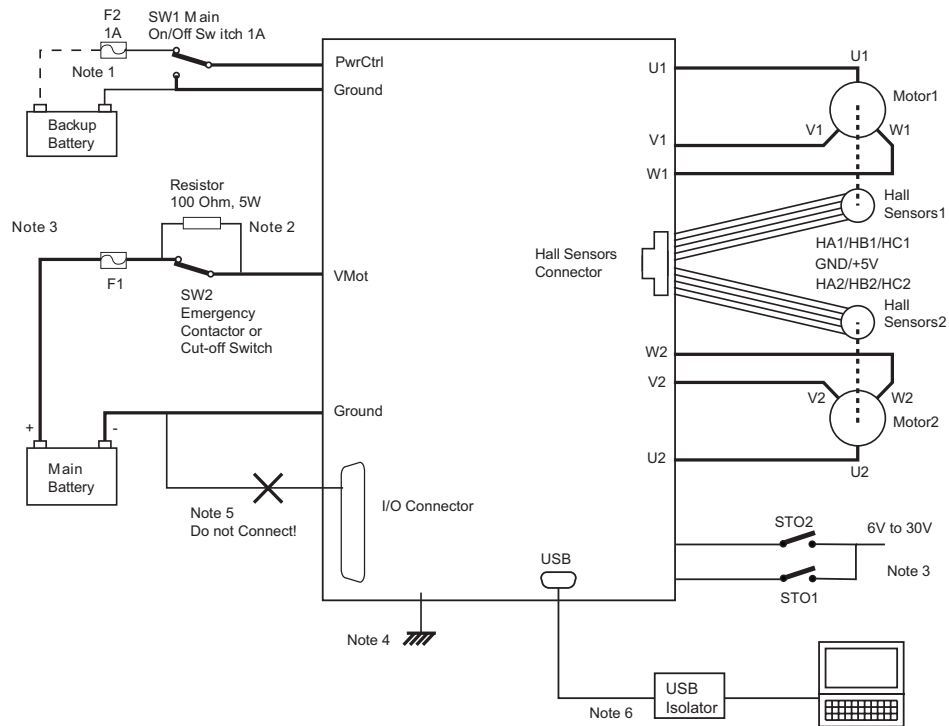

FIGURE 3. Powering the controller. Thick lines identify MANDATORY connections

Caution

Carefully follow the wiring instructions provided in the Power Connection section of the Roboteq Controllers User Manual. The information on this datasheet is only a summary.

Mandatory Connections

It is imperative that the controller is connected as shown Figure 3. All connections shown as thick black lines are mandatory. The controller must be powered On/Off using switch SW1 on the PwrCtrl tab. Use a suitable high-current fuse F1.

Emergency Switch or Contactor

The battery must be connected Permanently to the controller's Vmot tabs via a high-power emergency switch or contactor SW2. The user must be able to deactivate the switch or contactor at any time, independently of the controller state. SW2 should be used only in emergency situations and not for normal operation. Opening SW2 while the motors are rotating can lead to permanent hardware damage.

Power On/Off Switch

The **controller must be powered On/Off using switch SW1** on the Power Control pin.

Note 1: To ensure motor operation with weak or discharged batteries, connect a second battery to the Power Control pin via the SW1 switch. This will keep the controller alive and responding even if no voltage is present on the Vmot terminal.

Precharge Resistor

The controller has 2350uF of internal capacitance which will cause a brief yet significant current inrush the moment power is applied.

Note 2: If there is a concern that this current can overload the power supply or the contactor, insert a precharge resistors as shown in figure 3. For precharging to take place, the controller must be turned off by grounding the Power Control pin.

Enable Safe Torque Off

Note 3: When STO is enabled (STO jumper removed), the motor will be prevented from running until both of its STO inputs are connected to a voltage of 6V or higher. If one or both STO lines are left floating or grounded, the drive will be ON and able to communicate, but the motor will not be driven. For more details, refer to the STO chapter further down in this document and consult the Roboteq Controllers User Manual.

Regeneration Protection and Braking

During rapid deceleration, the kinetic energy will cause regenerative current to flow out of the motor and back to the power source. When using a battery, this current will recharge the battery and create a dynamic braking effect. When a power supply is used, the current will not be able to flow back to the source. Without a return path, the regenerative current can cause the voltage to rise to a dangerous level for the electronics.

Connection to Chassis

Note 4: For improved EMI immunity and reduced emissions, it is recommended to connect the controller's bottom plate to the system's chassis. Note that the integrated controller's ground is not DC-electrically connected to the plate. However, there is a capacitor between the controller's ground and the bottom plate, providing AC conductivity.

Avoid Alternate Ground Paths

Note 5: Be cautious not to create a path between the ground pins on the I/O connector and the battery's negative terminal. An internal connection already exists between the battery's negative pole and the control ground. Avoiding an additional external connection is highly recommended, as this could allow current to circulate in the signal ground, potentially introducing noise into low-power signals. If the main power ground terminal becomes loose or disconnected, very high current from the motor may flow through the signal ground wire, causing damage.

Precautions When Connecting PC via USB

Note 6: Always use a USB isolator to protect both the drive and the PC against potential electrical damage. When using a portable PC, operate it on battery power to avoid creating an accidental return ground path via the charger.

Electrostatic Discharge Protection

In accordance with IEC 61000-6-4, Roboteq Motor Controllers are designed to withstand ESD up to 4kV touch and 8kV air gap. This protection is implemented without any additional external connections required.

Some specifications, such as EN12895, require a higher level of protection. To maximize ESD protection, up to 8kV touch and 15kV air gap, connect the metallic heatsink of the controller to the battery's negative terminal.

Single Channel Wiring

On the Single Channel FBLG2360TS, each of the motor wires must be connected to both output tabs labeled with the same letter, as shown in figure 4. The sensors connected to Channel One will be used for the motor's operation.

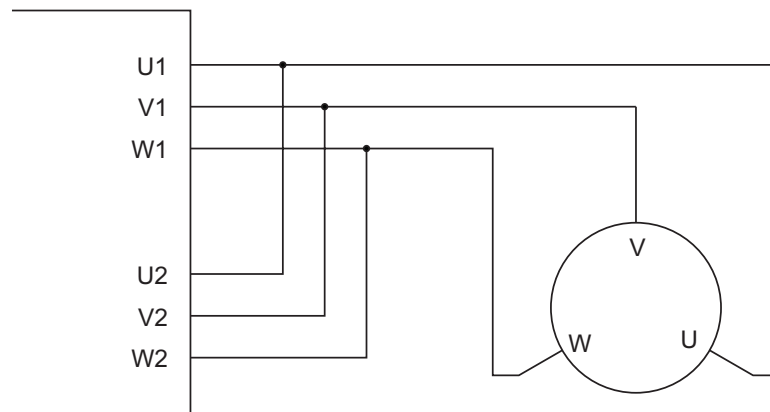

FIGURE 4. Single Channel wiring diagram

Caution

This wiring must be done only on the single channel version of the controller. Paralleling the wires on a dual channel product will cause permanent damage. Verify that your controller is an -S model before you wire in this manner.

Controller Mounting

The drive should be mounted in such a way that its bottom surface makes direct contact with a metallic surface, such as the system chassis or cabinet. This will assist in dissipating the heat generated during the operation of the controller. It's important to note that the nominal and peak ampere values documented in the datasheet can only be fully achieved with adequate cooling.

Hall Sensors Connection

Connection to the Hall Sensors is done using a 10-pin Molex Microfit 3.0, ref. 43025-1000. Pin assignment is in table 1.

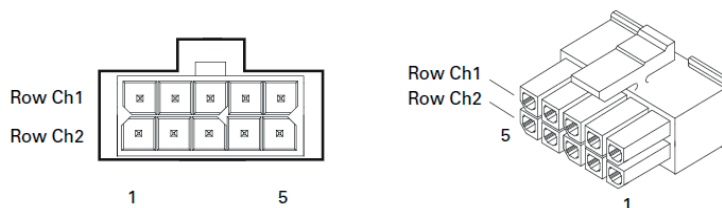

FIGURE 5. Hall Sensors connector

TABLE 1.

Pin Number	1	2	3	4	5
Row Ch1	5V	Hall1 C	Hall1 B	Hall1 A	Ground
Row Ch2	5V	Hall2 C	Hall2 B	Hall2 A	Ground

Connection to SSI Absolute Encoder

Both multi-turn and single-turn SSI sensors are supported in sinusoidal mode, with a resolution of up to 48 bits. These SSI sensors must be connected to the 10-pin Molex connector, which is also used for Hall sensors. The specific sensor connected to the Molex connector can be determined through the controller’s configuration settings. The controller employs differential signals for both clock and data. While data signals are separate for each channel, the clock signal is common to both. Therefore, for dual-channel operation, both sensors should be connected to the ‘Clock -’ and ‘Clock +’ pins. The Molex connector pin assignment for the SSI sensor is shown in Table 2.

TABLE 2.

Pin Number	1	2	3	4	5
Row 1	5V	Clock -	Data 2 -	Data 1 -	GND
Row 2	5V	Clock +	Data 2 +	Data 1 +	GND

Connection to Analog Sin/Cos Absolute Encoder

The FBLG2360T features four high-speed analog inputs, designed to capture the absolute angular position data from either resolvers or magnetic sensors that have sin/cos voltage outputs. For the sin/cos sensors, the signal must range from 0 to 5V, with 0 at 2.500V. The table 3 shows the signals assignment on the 25-pin connector.

TABLE 3.

Signal	Pin Number	Pin Name
Sin1	9	ASIN1
Cos1	10	ACOS1
Sin2	24	ANA7/ASIN2
Cos2	12	ANA8/ACOS2

Connecting Resolver

The wiring for the resolver is similar to a Sin/Cos sensor with the addition of an excitation signal. Figure 6 shows the necessary connections.

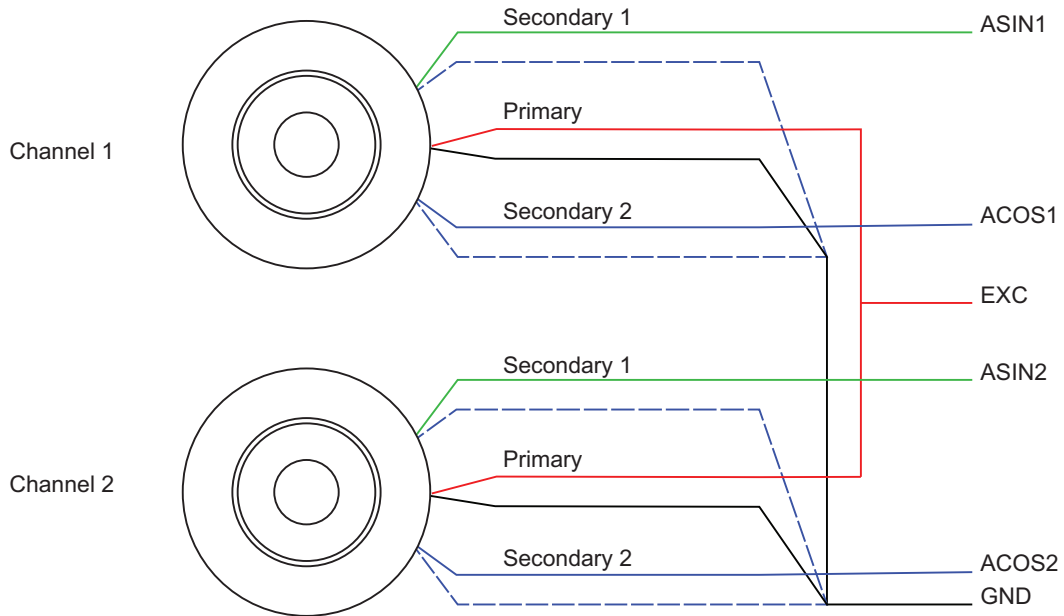

FIGURE 6. Resolver wiring

The table 4 shows the resolver signals assignment on the 25-pin connector.

TABLE 4.

Signal	Pin Number	Pin Name
Sin1	9	ASIN1
Cos1	10	ACOS1
Sin2	24	ANA7/ASIN2
Cos2	12	ANA8/ACOS2
Exc	17	ANA4/EXC
GND	1-5 or 13	GND

Commands and I/O Connections

Connection to external devices, such as RC radios, microprocessors, joysticks, sensors, and low current actuators, is done through the DB25 connector. The controller is equipped with general-purpose inputs that can be configured to function as digital, analog, or pulse inputs. Additionally, it features open collector outputs capable of driving resistive or inductive loads of up to 1 A. The pin assignment can be found on table 5. Please note that the signals from the DB25 port are susceptible to electrical noise interference, which can distort them and affect their readability. To mitigate this issue, always add Common Mode Choke coils when using DB25 connector cables that are longer than 1 meter.

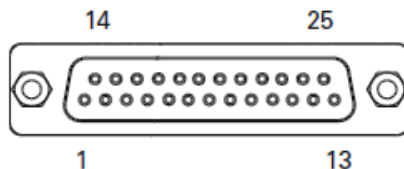

FIGURE 7. Main Connector pin locations

TABLE 5.

Connector Pin	Power	Dout	STO	Com	Pulse	Ana	Dinput	Enc
1	GND							
14	5VOut							
2				RSTxD				
15			STO1 (1)		RC1 (3)	ANA1	DIN1	
3				RS RxD				
16			STO2 (1)		RC2 (3)	ANA2	DIN2	
4					RC3	ANA3	DIN3	
17					RC4	ANA4/EXC (2)	DIN4	
5	GND							
18		DOUT1						
6		DOUT2						
19		DOUT3						
7		DOUT4						
20				CANH				
8				CANL				
21					RC5	ANA5	DIN5	ENC2A
9						ASIN1	DIN9	
22					RC6	ANA6	DIN6	ENC2B
10						ACOS1	DIN10	
23				485 +				
11				485 -				
24					RC7	ANA7/ASIN2	DIN7	ENC1A
12					RC8	ANA8/ACOS2	DIN8	ENC1B
25	5VOut							
13	GND							

Note 1: STO jumper must be removed for STO signals to be active. See STO section for details.

Note 2: Input 4 has a large capacitance which may degrade the Pulse signal. Prefer any of the other pulse inputs.

Note 3: Do not use for multiPWM input signals.

Enabling Analog Commands

The Analog command mode is disabled by default. To enable this mode, use the PC utility and set “Analog” in Command Priority 2 or 3 (leave “Serial” as priority 1). Note that by default, additional safety features are enabled, preventing the motor from starting unless the potentiometer is centered, or if the voltage is below 0.25V or above 4.75V. Use the PC utility to enable and assign analog inputs.

Connecting Thermistors

10 KOhm NTC temperature sensors can be connected to the controller’s analog inputs. This enables reading of motor temperature through the controller’s runtime variables and allows for active temperature protection. This connection can be achieved by using a 10 KOhm pull-up resistor between the analog input and the controller’s 5V output. For more information about motor temperature readings and controller parameterization, please refer to the Roboteq Controller’s User Manual.

USB Communication

Use the USB only for configuration, monitoring, and troubleshooting purposes. USB is not a reliable method of communication and can lead to disconnections when used in electrically noisy environments. These disconnections often require resetting the USB connection or even the controller. For more reliable interfacing with a computer, always opt for RS232 communication.

Important Note

Always use a USB isolator to protect both the drive and the PC from potential electrical damage. When using a portable PC, operate it on battery power to avoid an accidental ground path return via the charger.

CAN Communication

CAN is the FBLG2360T’s primary and recommended communication interface. Up to 127 drives can be networked on a twisted pair network up to 1000m long and at speeds up to 1Mbit/s. Roboteq support four CAN protocols:

- CANOpen for interoperability with other vendor’s DS301 and DS402 compliant devices
- RoboCAN, a simple and effective peer to peer meshed network protocol
- MiniCAN, a simplified subset of CANOpen PDOs
- Raw CAN, a low-level system used with scripting for constructing and parsing CAN frames to handle any protocols

TABLE 6. CANOpen Communications Specification

Feature	Value
Motion Network type	CAN, CANOpen
CANOpen Standards Support	DS301, DS402
Operating Modes	Cyclic sync torque, cyclic sync velocity, cyclic sync position, profile position, profile velocity, profile torque modes, homing
Process Data Objects (PDO)	Cyclic sync and free run modes. Cyclic messages can be set for 20 objects on 4 maps

RS485 Communication

RS485 is a robust industry standard for serial communication, well-suited for long distances and electrically noisy industrial settings. It uses balanced signaling for enhanced stability, allowing the connection of multiple receivers on a single network. The protocol supports half-duplex operation and is particularly compatible with Modbus. The 25-pin connector features designated pins for RS485+ and RS485-.

Ethernet and EtherCAT Communication

The FBLG2360T is available in several versions, each supporting different Ethernet-based communication protocols and fieldbuses.

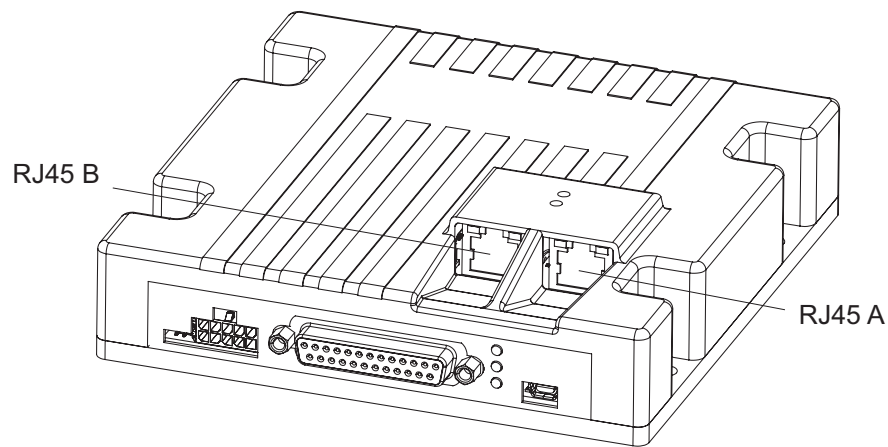

FIGURE 8. Ethernet Ports location

The FBLG2360TC is a version that supports the EtherCAT interface. EtherCAT is an Ethernet-based communication protocol designed for fast and precise synchronization in multi-drive, multi-axis systems. The controller supports CANOpen over EtherCAT (CoE), meaning it utilizes the CANOpen DS402 object directory and operating modes. Connection to the EtherCAT bus is facilitated through two RJ45 connectors. See the EtherCAT/CAN Networking Manual for details

The FBLG2360TE version supports all the controller's serial commands over a TCP/IP connection. Modbus TCP protocols are also supported in that version. Please note that the Motor and Tuning Wizard is not available through the TCP/IP connection.

Status LED Flashing Patterns

After the controller is powered on, the Power LED will turn on, indicating that the controller is active. The Status LED will flash at two-second intervals. The flashing pattern and color provide information on operating status or exceptions.

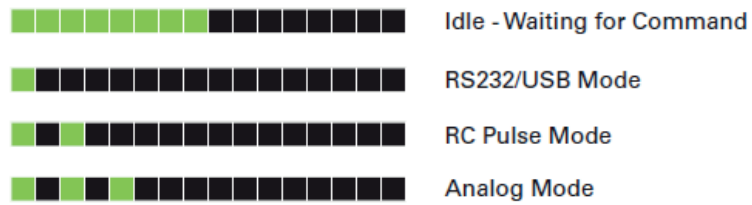

FIGURE 9. Normal Operation Flashing Patterns

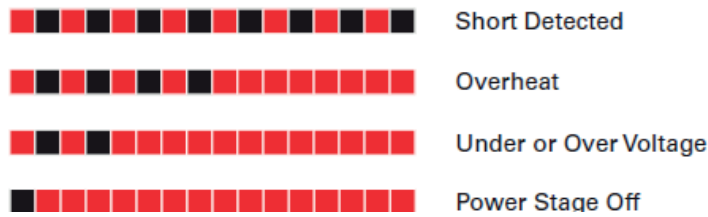

FIGURE 10. Exception or Fault Flashing Patterns

Additional information about the controller’s status and fault conditions can be obtained by monitoring the controller through the PC utility. The Communication LED indicates the status of USB and CAN Bus connectivity.

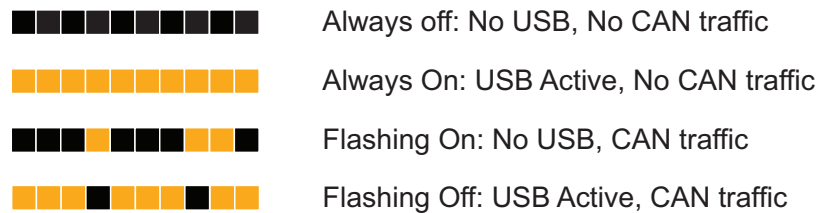

FIGURE 11. Exception or Fault Flashing Patterns

Battery Backed Clock and Variables

The controller includes a real-time clock/calendar and RAM storage for user variables. Both the clock and the RAM storage require a battery to continue running and for the stored data not to be lost while the controller is powered down. The battery is not installed by Roboteq. Users who wish to use the clock and/or battery backed RAM variables must install a CR1225 or equivalent battery. The battery socket can be reached by removing the screws that are holding the cover. Lift the cover to reach the board and insert a 3V, 12.5mm coin-style battery.

Safe Torque Off - STO (Certification Pending)

Safe Torque Off (STO) is a secure method for switching the controller into a state where no torque is generated, regardless of whether the controller is operating normally or is faulty. The STO functionality is achieved through redundant circuitry, incorporated into the STO1 and STO2 inputs of the controller. For the controller to operate normally, both STO inputs must be supplied with a voltage ranging from 6 to 30V. The controller performs a self-test of the STO circuitry every time it powers on, or when both STO inputs go high. If the STO circuitry is found to be functioning properly, the controller will allow the motor to be energized. In the event of an STO failure or if not both STO inputs are in a high state, the power stage will be cut off. Since STO is a hardware implementation and has been verified and validated by Roboteq, it can be trusted to bring the motor to a no-torque condition without the need for an external relay to cut power to the motor. For more information about STO functionality, refer to the STO Manual.

By factory default, the STO functionality is disabled by adding a jumper that bypasses the STO circuitry. To enable the STO feature, remove the jumper located on the front side of the controller and then enable the STO function in the controller’s configurations. The exact location of the jumper can be observed in figure 1.

Figure 12 illustrates the STO operation. To properly trigger the STO, both STO inputs must be in a high state. To properly release the STO, both STO inputs must be low. Having only one of the two STO inputs in a high state will trigger the “STO fault” alarm.

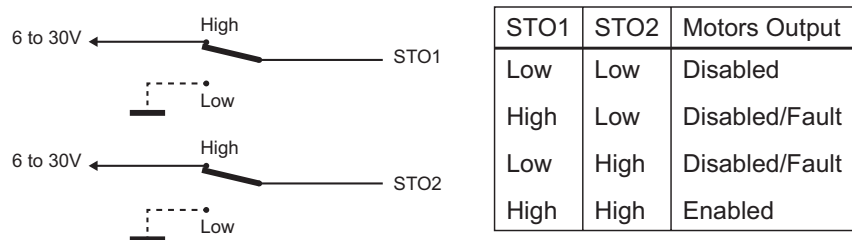

FIGURE 12. STO input levels effects on controller output

The STO function is compliant to:

- IEC 61800-5-2:2017, SIL 3
- IEC 61508:2010, SIL 3
- IEC 62061:2015, SIL 3
- ISO 13849-1:2015, Category 3 Performance Level e

Warning

Activating STO causes the motor to float and cease torque generation. Since the motor will not be actively braked, it will decelerate solely due to the system's friction. In mobile robot applications, the robot may continue moving for several meters before coming to a complete stop. For safe operation, additional braking measures should be implemented when STO is enabled, such as utilizing a mechanical or electrical brake. Roboteq offers one solution in the form of the SBSxxxx Safety Electric Brake Switch series, which quickly stops the motor by shorting its phases when STO is triggered.

Electrical Specifications

Absolute Maximum Values

The values in Table 7 should never be exceeded, as doing so may result in permanent damage to the controller.

TABLE 7.

Parameter	Measure point	Min	Typ	Max	Units
Battery Leads Voltage	Ground to Vmot			65 (1)	Volts
Reverse Voltage on Battery Leads	Ground to Vmot	-1			Volts
Power Control Voltage	Ground to PwrCtrl wire			65 (1)	Volts
Motor Leads Voltage	Ground to U, V, W wires			60 (1)	Volts
Digital Output Voltage	Ground to Output pins			30	Volts
Analog and Digital Inputs Voltage	Ground to any signal pin on DB25 & Hall inputs			30	Volts
RS232 I/O pins Voltage	External voltage applied to Rx pins			30 (2)	Volts
Case Temperature	Case	-40		85	°C
Humidity	Case			100 (3)	%

Note: Only PELV/SELV voltages shall be used
 Note 1: Can be even higher because of regeneration voltage. Never inject a DC voltage from a battery or other fixed source
 Note 2: No voltage must be applied on Tx pin
 Note 3: Non condensing

Power Stage Electrical Specifications (at 25°C ambient)

TABLE 8.

Parameter	Measure point	Model	Min	Typ	Max	Units
Input Voltage	Ground to Vmot	All	0 (1)		60	Volts
Input continuous Max Current	Power source current	All			80	Amps
Output Voltage	Ground to U, V, W wires	All	0 (1)		60 (2)	Volts
Power Control Voltage	Ground to Power Control wire	All	0 (1)		65	Volts
Minimum Operating Voltage	VBat or PwrCtrl wires	All	12 (3)			Volts
Over Voltage protection range	Ground to Vmot	All	5	60 (4)	63	Volts
Under Voltage protection range	Ground to Vmot	All	0	5 (4)	63	Volts

TABLE 8.

Parameter	Measure point	Model	Min	Typ	Max	Units
Input Capacitance	Ground to Vmot	All		2350		uF
Idle Current Consumption	Vmot or PwrCtrl wires	All	50	100 (5)	150	mA
ON Resistance (Excluding wire resistance)	Vmot to U, V or W. Ground to U, V or W	FBLG2360T		2.5		mOhm
		FBLG2360TS		1.25		mOhm
Max Current for 30s	Motor current	FBLG2360T			60	Amps
		FBLG2360TS			120	Amps
Continuous Max Current per channel	Motor current	FBLG2360T			40 (6)	Amps
		FBLG2360TS			80 (6)	Amps
Current Limit range	Motor current	FBLG2360T	10	50 (7)	60	Amps
		FBLG2360TS	20	100 (7)	120	Amps
Stall Detection Amps range	Motor current	FBLG2360T	10	60 (7)	60	Amps
		FBLG2360TS	20	120 (7)	120	Amps
Stall Detection timeout range	Motor current	All	1	500 (8)	65000	msec
Short Circuit Detection threshold (9)	Between Motor wires or Between Motor wires and ground or Between Motor wires and Vmot	FBLG2360T			120(10)	Amps
		FBLG2360TS			220(10)	Amps
Motor Acceleration/ Deceleration range	Motor Output	All	100	500(11)	65000	msec
Power cable thickness	Power input and output	All		8		AWG

Note 1: Negative voltage will cause a large surge current. Protection fuse needed if battery polarity inversion is possible

Note 2: Can be even higher because of regeneration voltage. Never inject a DC voltage from a battery or other fixed source

Note 3: Minimum voltage must be present on VBat or Power Control wire

Note 4: Factory default value. Adjustable in 0.1V increments

Note 5: Current consumption is lower when higher voltage is applied to the controller's VBat or PwrCtrl wires

Note 6: Estimate. Limited by case temperature. Current may be higher with better cooling

Note 7: Factory default value. Adjustable in 0.1A increments

Note 8: Factory default value. Time in ms that Stall current must be exceeded for detection

Note 9: Controller will stop until restarted in case of short circuit detection" change with "Controller will stop until zero command given in case of short circuit detection

Note 10: Approximate value

Note 11: Factory default value. Time in ms for power to go from 0 to 100%

Command, I/O and Sensor Signals Specifications

TABLE 9.

Parameter	Measure point	Min	Typ	Max	Units
Main 5V Output Voltage	Ground to 5V pins on	4.6	4.9	5.2	Volts
5V Output Current	5V pins on RJ45 and DSub15			200 (1)	mA
Digital Output Voltage	Ground to Output pins			30	Volts
Output On resistance	Output pin to ground		0.25	0.5	Ohm
Output Short circuit threshold	Output pin	1.7		3.5	Amps
Digital Output Current	Output pins, sink current			1.5	Amps
Input Impedances (except DIN11-19)	AIN/DIN Input to Ground		53		kOhm
Digital Input 0 Level	Ground to Input pins	-1		1	Volts
Digital Input 1 Level	Ground to Input pins	3.8		30	Volts
Analog Input Range	Ground to Input pins	0		5.1	Volts
Analog Input Precision	Ground to Input pins		0.5		%
Analog Input Resolution	Ground to Input pins		1		mV
Encoder Frequency	Encoder input pins			200	kHz
Pulse durations	Pulse inputs	20000		10	us
Pulse repeat rate	Pulse inputs	50		250	Hz
Pulse Capture Resolution	Pulse inputs		1		us
Min Pulse On/Off Duration	Pulse inputs		25		us
Frequency Capture	Pulse inputs	100		1000	Hz
Note 1: Sum of all 5VOut outputs					

Operating & Timing Specifications

TABLE 10.

Parameter	Measure Point	Min	Typ	Max	Units
Command Latency	Command to output change	0	0.5	1	ms
Max PWM duty cycle	Motor Output			93.8	%
Closed Loop update rate	Internal		1000 (1)		Hz
Current Loop update rate	Internal		16000		Hz
RS232 baud rate	Rx & Tx pins		115200 (2)		Bits/s
RS232 Watchdog timeout	Rx pin	1 (3)		65000	ms
Note 1: Applies to closed loop speed and closed loop position modes only					
Note 2: 115200, 8-bit, no parity, 1 stop bit, no flow control					
Note 3: May be disabled with value 0					

Motor Characteristics Requirement for FOC current control

For proper FOC current control and motor operation under sinusoidal commutation, it is necessary for the motor to meet a minimum load inductance, minimum time constant (L/R) and maximum electric operating speed requirements. The minimum required inductance is necessary to ensure low Total Harmonic Distortion (THD) of the motor current. Furthermore, to achieve proper current control and stability, the controller's current loop sampling rate will determine the minimum permissible motor time constant and the maximum operating electric speed.

TABLE 11.

Parameter	Input DC Voltage (V)	Value	Units
Minimum load phase inductance (1)	12	25	uH
	24	40	uH
	48	60	uH
	60	80	uH
Minimum load inductance/resistance ratio (1)	0 - 60	0.063	msec
Maximum operating electric speed (2)	0 - 60	96000	RPM
Note 1: Star connected three phase load considered. In case the motor phase inductance does not fulfill the above requirements (minimum phase inductance and inductance/resistance ratio) an external AC inductor with proper inductance value is recommended to be added.			
Note 2: Maximum rotor speed is calculated from the maximum operating electric speed and pole pairs. For example, in a motor with 4 pole pairs the maximum operating rotor speed is $96000/4 = 24000$ rpm			

Scripting

TABLE 12.

Parameter	Measure Point	Min	Typ	Max	Units
Scripting Flash Memory	Internal		32K		Bytes
Max Basic Language programs	Internal	2000		3000	Lines
Integer Variables	Internal		4096		Words (1)
Boolean Variables	Internal		8192		Symbols
Execution Speed	Internal	50 000	100 000		Lines/s
Note 1: 32-bit words					

Thermal Specifications

TABLE 13.

Parameter	Measure Point	Min	Typ	Max	Units
Case Temperature	Case	-40		85 (1)	°C
Thermal Protection range	Case	80		90 (2)	°C
Power Dissipation	Case			70	Watts
Thermal resistance	Power MOSFETs to case			0.6	°C/W
Humidity	Case			95	%
Ambient temperature	Ambient			40	°C
Pollution Degree	-				
Fast fuse to install (3)	FBLG2360T (4)		2 x 60		Amps
	FBLG2360TS (4)		2 x 60		Amps
Overload motor protection	-	Check note 5			
Note 1: Thermal protection will protect the controller power					
Note 2: Max allowed power out starts lowering at minimum of range, down to 0 at max of range					
Note 3: There are two power terminal tabs. Fuse should be installed in both of them for safety					
Note 4: In dual channel controller, for operating only one channel install 60A fuse and for operating both channels 2 x 60A fuse should be installed. Power source must be capable to blow the fuse instantly in case of short circuit					
Note 5: Current limiting mechanism available through firmware. External overload motor protection can be used if required (provided by user)					

STO Specifications

TABLE 14.

Parameter	Measure Point	Min	Typ	Max	Units
STO Input High Level	Ground to STO input pin	6		30 (1)	Volts
STO Input Low Level	Ground to STO input pin	0		1	Volts
STO Response Time	Input to output change			5	msec
STO Operating temperature		-20		55	°C
STO Storage temperature		-20		70	°C
Humidity		5		95	%
IP degree				IP40	
Operating Altitude				2000	m
Cable Length				2	m
EMC Immunity	According to IEC 61800-3 and IEC 61800-5-2 Annex E				
CE Declaration	Available at www.roboteq.com				

Mounting and Thermal Consideration

Mechanical Specifications

TABLE 15.

Parameter	Measure Point	Min	Typ	Max	Units
Weight	Board		500 (1)		g (lbs)
Power Connectors width	Terminal tab		0.25		Inches
Torque	D-sub standard connector		0.4 (3.54)		Nm (in-lbs)
Torque	Terminal block		0.8 (7.10)		Nm (in-lbs)
Torque	Mounting screws (4/M2.5)		0.36 (3.2)		Nm (in-lbs)

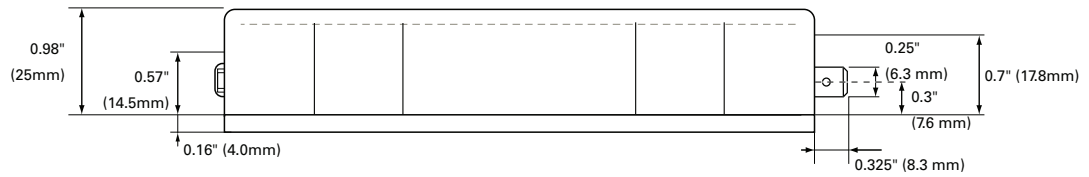

FIGURE 13. FBLG2360T side view and dimensions

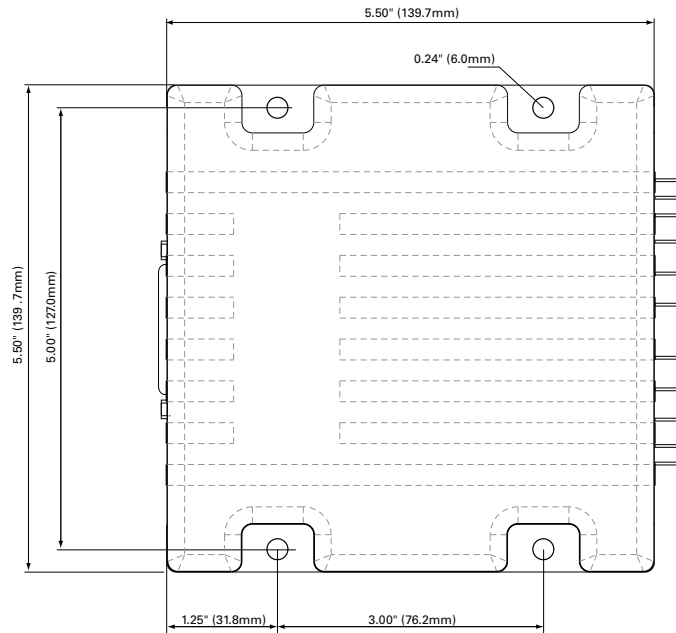

FIGURE 14. FBLG2360T top view and dimensions Mechanical Specifications