

Orientalmotor

*α*STEP AZ Series Equipped

Electric Linear Slides Electric Cylinders



*α*STEP AZ Series Equipped Electric Linear Slides and Electric Cylinders

Electric Linear Slides

EZS Series

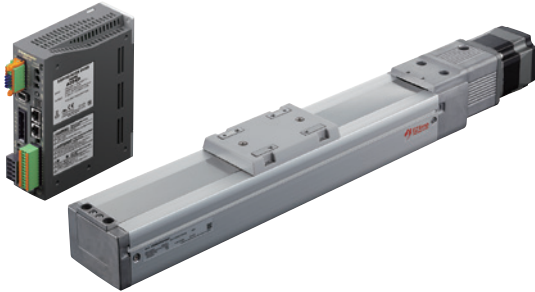

All models have an electromagnetic brake option available.

List price: Starting from 695.00 €*

- Flat
- High Rigidity
- Simple Dust-proof Structure

● Motor Installation Direction

Straight Type

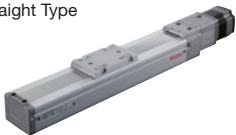

Reversed Motor Type

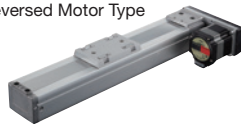

● For Cleanroom Use



EAS Series



Some models have an electromagnetic brake option available.

List price: Starting from 651.00 €*

- Thin
- Compact
- High Rigidity

● Motor Installation Direction

Straight Type



Reversed Motor Type



● Table Direction

X-Table

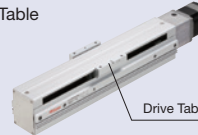

Y-Table



● With/Without Sensor Rails

With Sensor Rails

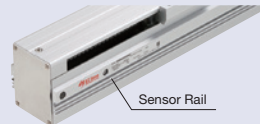

Without Sensor Rails

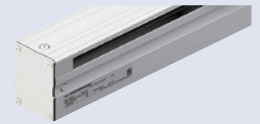

*α*STEP AZ Series

AZ Series products feature a battery-free absolute sensor that can perform accurate positioning operations with ease.

- Compact
- High Torque
- High Response
- Low Vibration
- No Hunting
- High Efficiency

■ What is the AZ Series with Built-in Battery-free Absolute Sensor

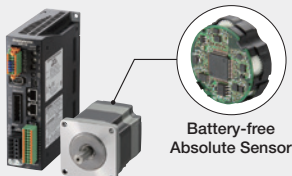

- Constant monitoring of a motor's position information with the built-in battery-free absolute sensor, without requiring an external sensor
- High reliability with closed loop control
- High efficiency technology reduces motor heat generation and saves energy

*α*STEP?

These *α*STEP stepper motor-based motors offer a unique form of hybrid control that combines the advantages of both open loop control and closed loop control. Under normal conditions, high responsiveness is achieved with open loop control. Under overload conditions, the motor continues to operate with position correction via closed loop control.

Because the motor, frame, guide rail, guide block, ball screw, and so on have already been selected and assembled, the design time and equipment startup time are shorter.

The **αSTEP AZ** Series is also equipped as the drive motor for unique hybrid control, offering both ease of use and reliability.

Electric Cylinders

EAC Series

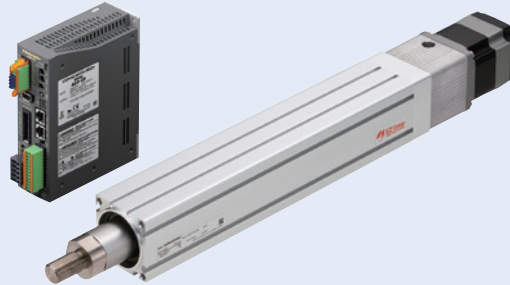

Some models have an electromagnetic brake option available.

List price: Starting from 539.00 €*

Compact

High Rigidity

High Thrust Force

● Motor Installation Direction

Straight Type



Reversed Motor Type

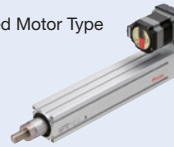

● Guide Type

Standard



Type with a Shaft Guide





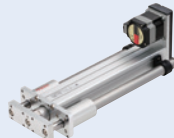

With Shaft Guide Cover



■ Various Combined Drivers

Combining both an electric linear slide and electric cylinder, the drivers and cables are common across the **αSTEPAZ** Series.

<p>Built-in Controller Type</p> <p>Set positioning data to the driver (up to 256). By using a network converter (sold separately), FA network control is possible.</p> 	<p>Pulse Input Type with RS-485 Communication</p> <p>The motor's position, speed, torque, alarm status and temperature can be monitored using RS-485 communication.</p> 	<p>Pulse Input Type</p> <p>Controls the motor using a positioning module (pulse generator).</p> 	<p>Network Compatible</p> <p>EtherNet/IP EtherCAT PROFINET</p> 	<p>Multi-axis Driver</p> <ul style="list-style-type: none"> · Can be connected to a DC Input actuator · Drivers with 2-axis, 3-axis and 4-axis connections are available 
---	--	--	--	---

■ The **αSTEPAZ** has a separate catalog. When selecting a product, please also use this individual catalog.



Selection of Electric Linear Slides

Series Type	Product Number Width × Height	Power Supply Voltage	Lead [mm]	Stroke [mm]											Max. Speed [mm/s]				
				100	200	300	400	500	600	700	800	900	1500	200	400	600	800	2000	
EZS Series αSTEP AZ Equipped Straight Type  Reversed Motor Type  For Cleanroom Use 	EZSM3 54×50 mm	AC Input	12	50~700											800				
			6	50~700											400				
		DC Input	12	50~700											600				
			6	50~700											300				
	EZSM4 74×50 mm	AC Input	12	50~700											800				
			6	50~700											400				
		DC Input	12	50~700											600				
			6	50~700											300				
	EZSM6 74×66.5 mm	AC Input	12	50~850											800				
			6	50~850											400				
		DC Input	12	50~850											600				
			6	50~850											300				
EAS Series αSTEP AZ Equipped Straight Type  Reversed Motor Type 	EASM2 30×38 mm*1	DC Input	6	50~300											300				
			3	50~300											150				
	EASM4 45×60 mm*1	AC Input	12	50~700											800				
			6	50~700											400				
		DC Input	12	50~700											600				
			6	50~700											300				
	EASM6 62×83 mm*1	AC Input	12	50~850											800				
			6	50~850											400				
		DC Input	12	50~850											600				
			6	50~850											300				





*1 The dimensions without sensor rails.

*2 The brackets () indicate the value of the reversed motor type.







	Upper Line: Dynamic Permissible Moment [Nm]			Horizontal Transportable Mass [kg]								Vertical Transportable Mass [kg]			Repetitive Positioning Accuracy [mm]	List Price Starting from	Reference Page
	Lower Line: Static Permissible Moment [Nm]			10	20	30	40	50	60	70	80	10	20	30			
	MP	MY	MR														
	4.2	4.2	10.5	7.5								3.5			±0.02	695.00 €	30
	26.4	26.4	52.0	15								7					
	4.2	4.2	10.5	7.5								3.5			±0.02	732.00 €	31
	26.4	26.4	52.0	15								7					
	8	8	27.8	15								7			±0.02	732.00 €	32 - 33
	51.2	42.5	176	30								14 (12.5) *1					
	8	8	27.8	15								7			±0.02	732.00 €	34 - 35
	51.2	42.5	176	30								14 (12.5) *1					
	45.7	37.5	55.6	30								15			±0.02	984.00 €	36
	290	187	340	60								30					
	45.7	37.5	55.6	30								15			±0.02	984.00 €	37
	290	187	340	60								30					
	2.4	1.5	4.6	7.5								2.5			±0.02	651.00 €	62
	4.0	4.0	7.7	15								5					
	16.3	4.8	15.0	15								7			±0.02	730.00 €	63 - 64
	58.3	16.0	53.3	30								14 (12.5) *1					
				15								7			±0.02	730.00 €	65 - 66
				30								14 (12.5) *1					
	31.8	10.3	40.6	30								15			±0.02	981.00 €	67
	86.0	34.0	110.0	60								30					
				30								15			±0.02	981.00 €	68
				60								30					

Various Combined Drivers

Combining both an electric linear slide and electric cylinder, the drivers and cables are common among the **QSTEP AZ** Series.

<p>Built-in Controller Type</p> <p>Set positioning data sets in the driver (up to 256). By using a network converter (sold separately), FA network control is possible.</p>  <p>Starting from 396.00 €</p>	<p>Pulse Input Type with RS-485 Communication</p> <p>The motor's position, speed, torque, alarm status and temperature can be monitored using RS-485 communication.</p>  <p>Starting from 396.00 €</p>	<p>Pulse Input Type</p> <p>Controls the motor using a positioning module (pulse generator).</p>  <p>Starting from 341.00 €</p>	<p>Network Compatible</p> <p>EtherNet/IP EtherCAT PROFINET</p>  <p>Starting from 440.00 €</p>	<p>Multi-axis Driver</p> <ul style="list-style-type: none"> Can be connected to a DC Input actuator Drivers with 2-axis, 3-axis and 4-axis connections are available  <p>Starting from 807.00 €</p>
--	--	--	---	---

Selection of Electric Cylinders





Series Type	Product Number Width × Height	Power Supply Voltage	Lead [mm]	Stroke [mm]				Max. Speed [mm/s]								Thrust Force [N]	
				100	200	300	400	100	200	300	400	500	600	700	800		
EAC Series αSTEP AZ Series Equipped Straight Type  Reversed Motor Type  	EACM2 28 × 28 mm	DC Input	6	50~150				300								25	
			3	50~150				150								50	
	EACM4 42 × 42 mm	AC Input	12	50~300				600								~70	
			6	50~300				300								~140 (125)*	
		DC Input	12	50~300				600								~70	
			6	50~300				300								~140 (125)*	
	EACM6 60 × 60 mm	AC Input	12	50~300				600								~200	
			6	50~300				300								~400 (360)*	
		DC Input	12	50~300				600								~200	
			6	50~300				300								~400 (360)*	
	EAC Series αSTEP AZ Series Equipped Straight Type With Shaft Guide Cover  Reversed Motor Type With Shaft Guide Cover  Straight Type Type with a Shaft Guide  Reversed Motor Type Type with a Shaft Guide 	EACM2W 28 × 86 mm	DC Input	6	50~150				300								25
				3	50~150				150								50
EACM4W 42 × 114 mm		AC Input	12	50~300				600								~70	
			6	50~300				300								~140 (125)*	
		DC Input	12	50~300				600								~70	
			6	50~300				300								~140 (125)*	
EACM6W 60 × 156 mm		AC Input	12	50~300				600								~200	
			6	50~300				300								~400 (360)*	
		DC Input	12	50~300				600								~200	
			6	50~300				300								~400 (360)*	

*The brackets () indicate the value of the reversed motor type.

	Push Force [N]	Horizontal Transportable Mass [kg]												Vertical Transportable Mass [kg]			Repetitive Positioning Accuracy [mm]	List Price Starting from	Reference Page			
		10	20	30	40	50	60	§	200	400	10	20	30									
	40	7.5																2.5		±0.02	539.00 €	95
	80	15															5					
	100	15															7		±0.02	560.00 €	97 - 98	
	200	30														14 (12.5)*						
	100	15														7		99 - 100				
	200	30													14 (12.5)*							
	400	30														15		±0.02	641.00 €	101 - 102		
	500	60													30							
	400	30													15		103 - 104					
	500	60													30							
	40	7.5														2.0		±0.02	770.00 €	96		
	80	15													4.5							
	100	15													6		±0.02	790.00 €	105 - 106			
	200	30												13 (11.5)*								
	100	15												6		107 - 108						
	200	30												13 (11.5)*								
	400	30												13		±0.02	912.00 €	109 - 110				
	500	60												28								
	400	30												13				111 - 112				
	500	60												28								

Various Combined Drivers

Combining both an electric linear slide and electric cylinder, the drivers and cables are common among the **αSTEP AZ** Series.

<p>Built-in Controller Type</p> <p>Set positioning data sets in the driver (up to 256). By using a network converter (sold separately), FA network control is possible.</p>  <p>Starting from 396.00 €</p>	<p>Pulse Input Type with RS-485 Communication</p> <p>The motor's position, speed, torque, alarm status and temperature can be monitored using RS-485 communication.</p>  <p>Starting from 396.00 €</p>	<p>Pulse Input Type</p> <p>Controls the motor using a positioning module (pulse generator).</p>  <p>Starting from 341.00 €</p>	<p>Network Compatible</p> <p>EtherNet/IP EtherCAT PROFINET</p>  <p>Starting from 440.00 €</p>	<p>Multi-axis Driver</p> <ul style="list-style-type: none"> Can be connected to a DC Input actuator Drivers with 2-axis, 3-axis and 4-axis connections are available  <p>Starting from 807.00 €</p>
--	--	--	---	---

Different Drivers are Available to Match the Host System.

Built-in Controller Type AC DC

With this type, the operating data is set in the driver, and is then selected and executed from the host system. Host system connection and control are performed with any of the following: I/O, Modbus (RTU), RS-485 communication, or FA network. By using a network converter (sold separately), CC-Link or MECHATROLINK communication is possible.

Basic Setting (Factory Setting)

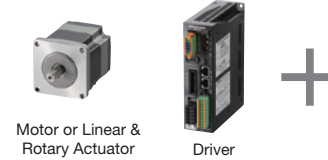

Setting Operating Data

Changing Parameters

Support Software (**MEXE02**)

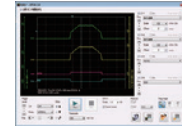

● Setting using RS-485 communication is also possible.



FLEX is the collective name for products that support I/O control, Modbus (RTU) control, and FA network control via network converters.

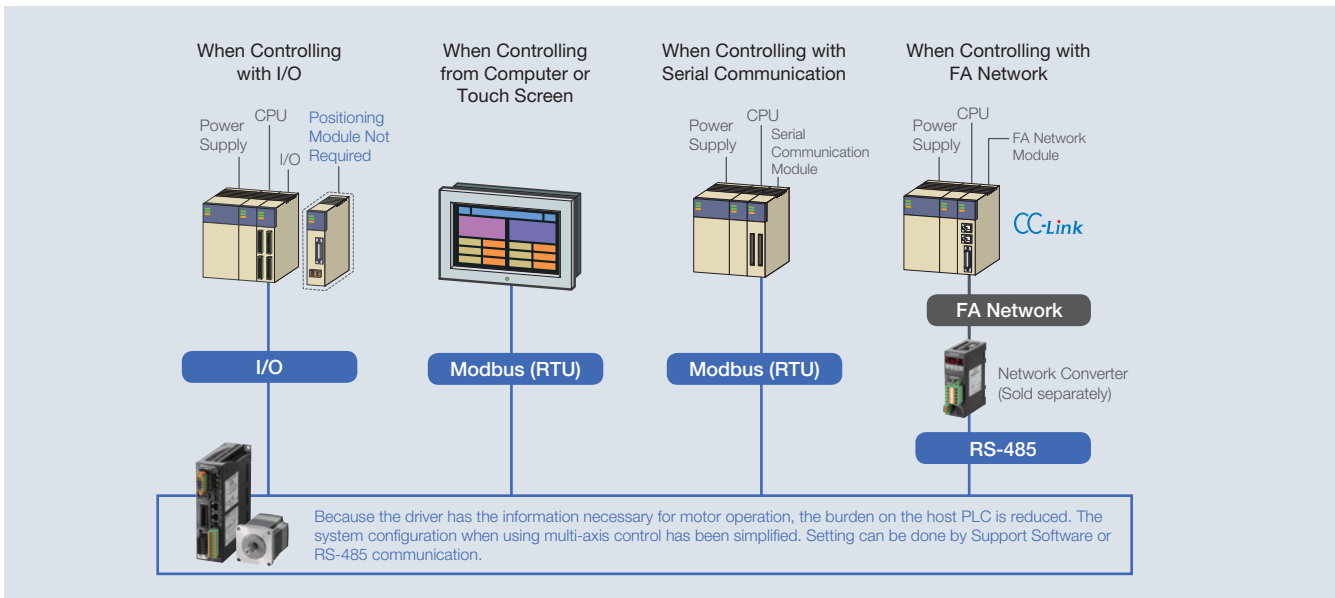

Pulse Input Type with RS-485 Communication AC DC

This type executes operations by inputting pulses into the driver. The motor can be controlled using a positioning module (pulse generator) provided by the customer. The motor's status information (position, speed, torque, alarm, temperature, etc.) can be monitored using RS-485 communication.

Basic Setting (Factory Setting)

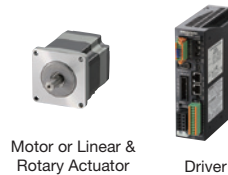

I/O Assignment Changing

Changing Parameters

Support Software (**MEXE02**)

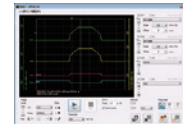

The alarm history can be checked and various conditions can be monitored using support software (**MEXE02**).

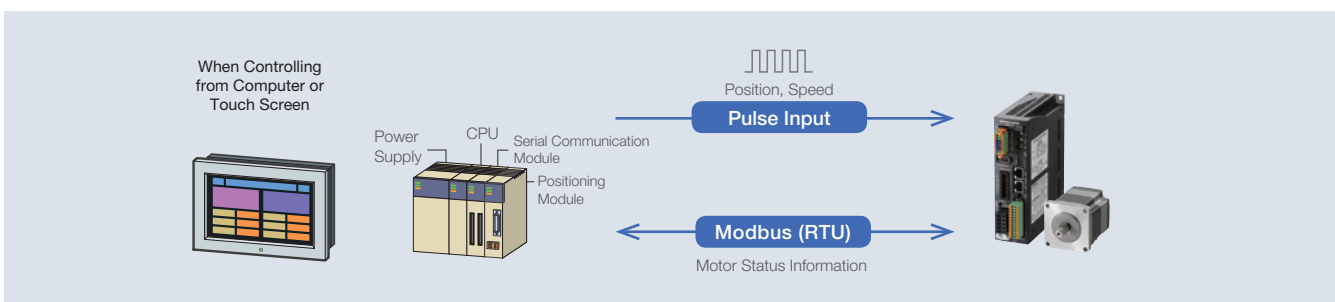

AC : Single-Phase 100-120 VAC, Single-Phase/Three-Phase 200-240 VAC Input

DC : 24/48 VDC Input

Pulse Input Type **AC** **DC**

This type executes operations by inputting pulses into the driver. The motor can be controlled using a positioning module (pulse generator) provided by the customer. The alarm history can be checked and various conditions can be monitored using Support Software (**MEXE02**).

Basic Setting (Factory Setting)



Motor or Linear & Rotary Actuator

Driver

I/O Assignment Changing Support Software (**MEXE02**)

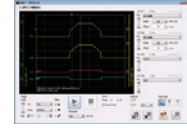

The alarm history can be checked and various conditions can be monitored using support software (**MEXE02**).

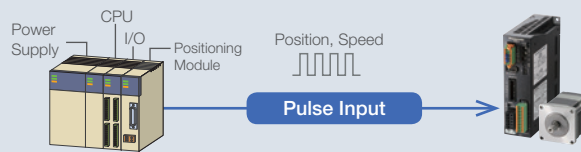

Network-Compatible Drivers **AC** **DC**

These drivers are compatible with EtherNet/IP, EtherCAT and PROFINET communication. They can be directly controlled from the network. The host control device and driver are connected with one communication cable, reducing wiring.

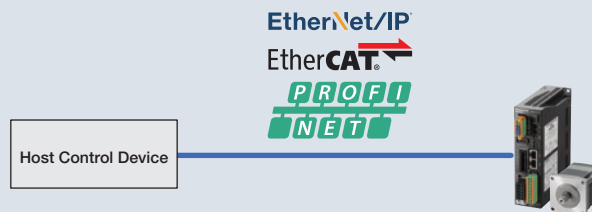

Network-Compatible Multi-axis Drivers **DC**

These multi-axis drivers are compatible with EtherCAT drive profile. They can be connected to **AZ** Series DC Input motors and their on-board linear & rotary actuators. Drivers with 2-axis, 3-axis and 4-axis connections are available.

*Product details are provided in the individual catalogs of the multi-axis drivers.

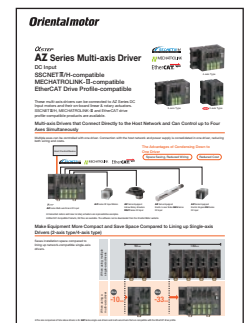

Individual Catalogues

- **CC-Link** is a registered trademark of CC-Link Partner Association, and **EtherNet/IP** is a registered trademark of ODVA.
- **EtherCAT** is a registered trademark for a patented technology licensed by Beckhoff Automation GmbH (Germany).
- **PROFINET** is a trademark or registered trademark of PROFIBUS Nutzerorganisation e.V. (PNO).

The **AZ** Series Offers Easy Settings and Useful Functions.



Support Software **MEXE02**

Support Software can be downloaded from the Oriental Motor website.

Easy Setting and Easy Operation

Basic settings can be performed with the Support Software **MEXE02**, such as operating data editing and parameter settings.

The sequence function also allows for advanced movement with simple input.

● Unit Setting Wizard

This is a function that allows the traveling amount, speed, etc. to be displayed and input in the designated units. Values can be displayed and set in the units that suit the mechanisms being used (mm, deg), eliminating unit conversion work and making it easy to input operating data.



● Creation of Recovery Data File

First, a file with the product's factory settings is created in preparation for product replacement during maintenance or when the product has been damaged.

Please be sure to create a recovery data file when using a linear & rotary actuator.

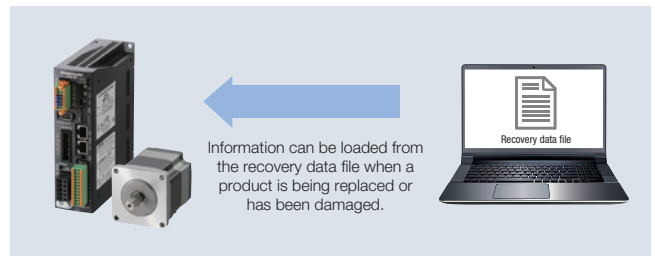

● Simplified Main Program with Sequence Function

AZ Series stored-data operations come with a variety of sequence functions, such as a timer setting between operations and linked operation, conditional branching, and loop counting.

These help simplify the host system's sequence program.

Built-in Controller Type

- Number of Positioning Operation Data Sets (Up to 256)
- General-Purpose I/O Signal Counts (Input 10, Output 6)
- Communication I/O Signal Counts (Input 16, Output 16)

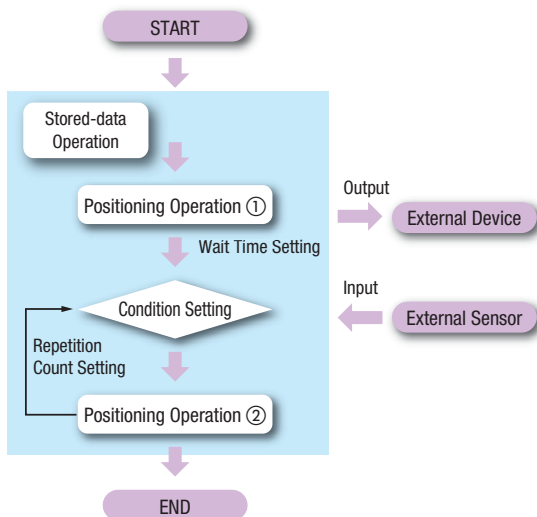

Test Function

This function enables you to operate a motor alone or check the connection to the host system. Using this function when starting up the equipment can reduce the overall startup time.

Teaching and Remote Operation On startup

Data setting software can be used to easily perform the home setting and also drive the motor. Teaching and test runs can be performed before connecting to the host system, shortening equipment startup time.

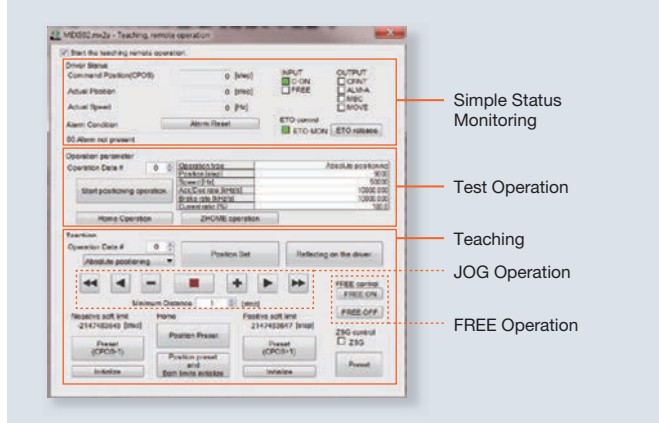

I/O Test On startup For operation

Input signals can be monitored, and output signals can be forced to output. This is a useful function for host system wiring and checking remote I/O operations.

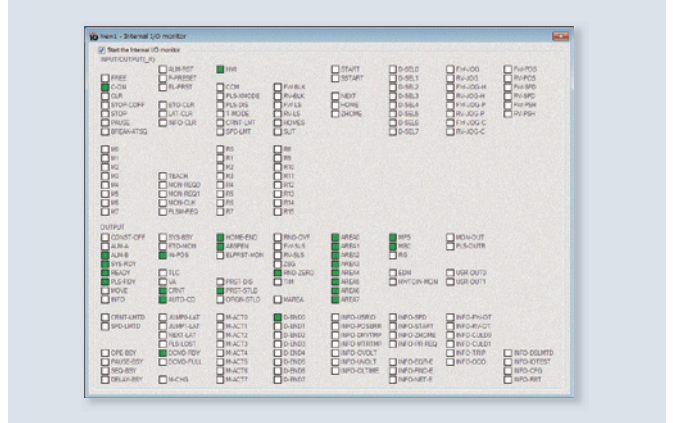

Various Monitoring Functions

Waveform Monitor On startup

The operating status of the motor and output signals can be monitored like an oscilloscope. This can be used for equipment start-up and adjustment.

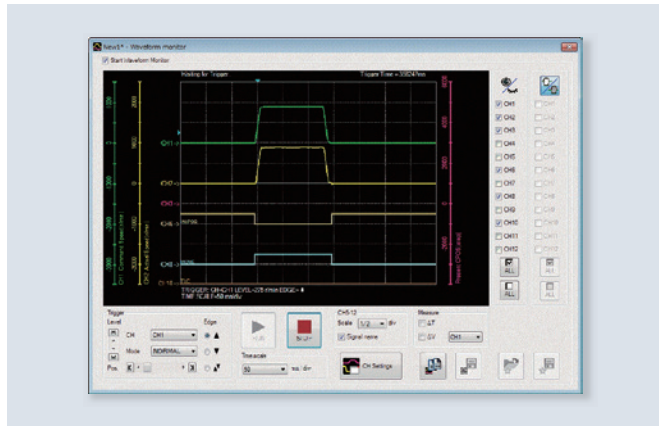

Alarm Monitor On startup

When an abnormality occurs, the details of the abnormality, the operating status at the time of the occurrence, and the solution can be checked.

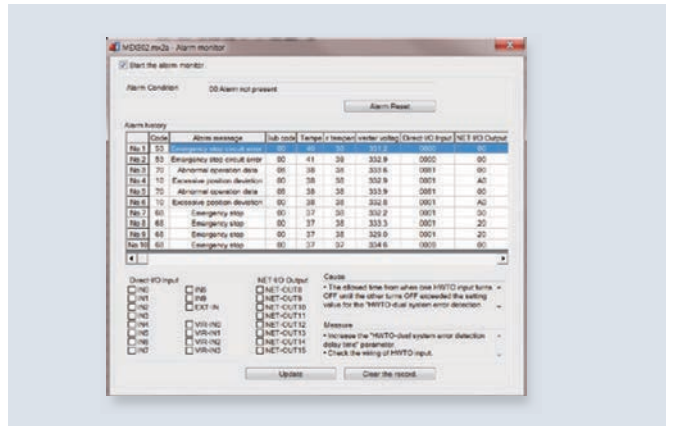

Status Monitor On startup

In addition to being able to monitor the speed, motor, driver temperature and load factor during operations, the integrating rotation amount, etc. can be monitored from the start of use. The signal for each item can be output at your discretion, which leads to effective maintenance.

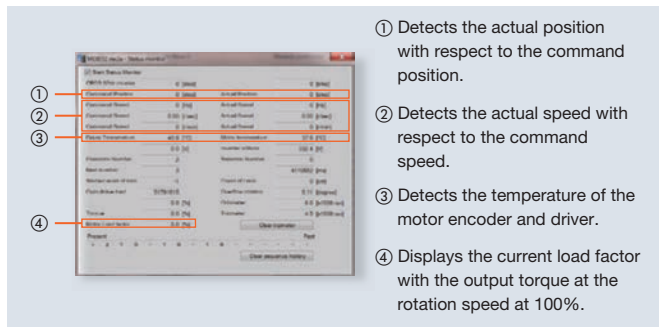

- ① Detects the actual position with respect to the command position.
- ② Detects the actual speed with respect to the command speed.
- ③ Detects the temperature of the motor encoder and driver.
- ④ Displays the current load factor with the output torque at the rotation speed at 100%.

Multi-monitoring Compatibility

Multiple settings screens, such as data settings, test operations and monitoring, can be simultaneously opened and used on separate screens. This makes equipment start-up and adjustment easy to accomplish.



Overview of Electric Linear Slides

The electric linear slide is a positioning linear slide consisting of an *αSTEP AZ* Series motor and frame, guide rail, guide block, and ball screw. They are capable of linear drive in a precise, accurate manner through the rotation of a ball screw and guide.

■ Highly Accurate Positioning Operation

The ball screw is rotated by a motor to drive a table fixed to a ball screw nut.

The guide rail can guide accurate linear motion and support the weight of the load, making highly accurate positioning of a large load possible.

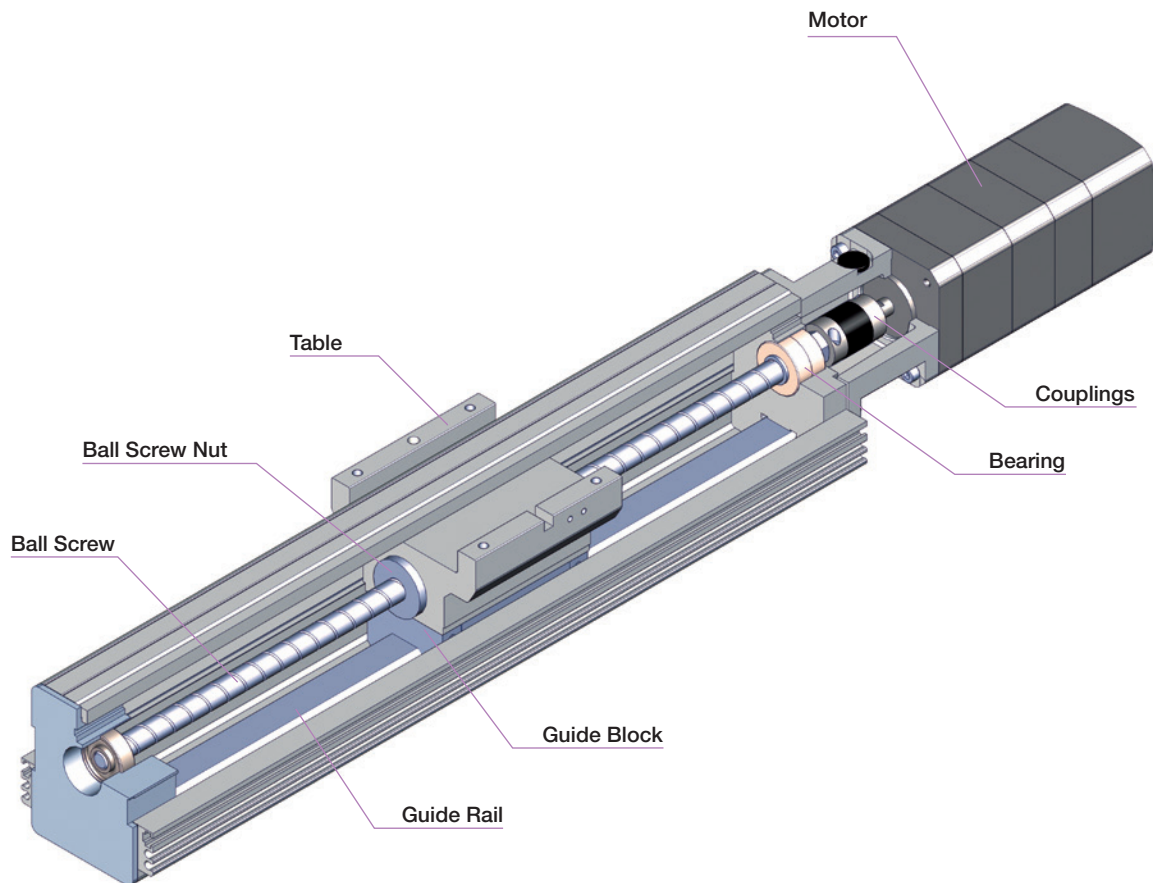

Types and Features of Electric Linear Slides

● EZS Series αSTEP AZ Series Equipped

EZS Series αSTEP AZ Series For Cleanroom Use

This is a compact and lightweight slide with an LM guide with ball retainer incorporated* in the frame. The slide is installed using the high-accuracy LM guide as a reference, allowing for traveling parallelism of 0.03 mm or less. The stainless sheet and roller structure suppresses dust caused by internal sliding.

Products for cleanroom use have the same functions and performance as the EZS Series.

*“Ball retainer” and “LM guide” are registered trademarks of THK Co, Ltd.

- Use of Ball Screw
- Repetitive Positioning Accuracy ± 0.02 mm

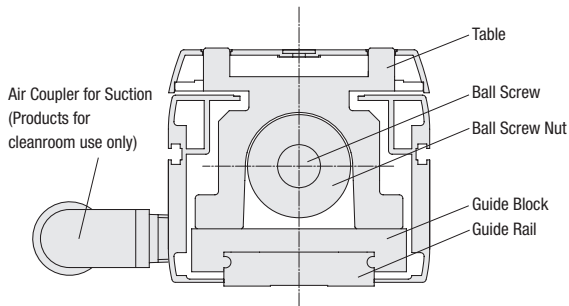

Straight Type

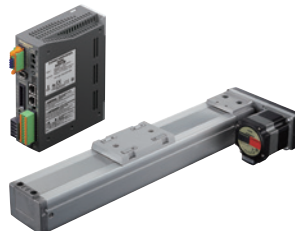

Reversed Motor Type (Right side/left side)

- This photo shows the left side type

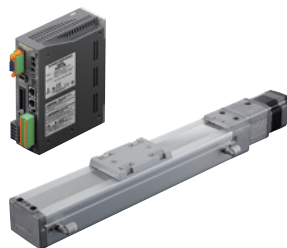

For Cleanroom Use (Suction joint right direction/suction joint left direction)

- This photo shows the suction joint left type
- Only the straight type is compatible for cleanroom use

● EAS Series αSTEP AZ Series Equipped

This is an electric linear slide with a ball screw and a ball retainer LM guide manufactured by THK*. This slide is suitable for applications where traveling parallelism is required because the highly accurate LM guide is directly installed to customer's enclosure base. (Traveling parallelism of 0.03 mm or less)

Although this slider is compact, it is rigid and can transport large masses.

*“Ball retainer” and “LM guide” are registered trademarks of THK Co, Ltd.

- Use of Ball Screw
- Repetitive Positioning Accuracy ± 0.02 mm

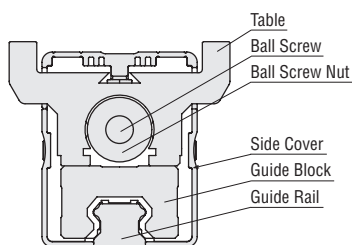

Straight Type





















































Reversed Motor Type (Right side/left side)

- This photo shows the right side type

List of Combinations

















AC Input

Product Line	Series	Product Name (On-board motor name)
Electric Linear Slides	EZS Series	EZSM3      AZAC (AZM46AC) EZSM3      AZMC (AZM46MC) EZSM4      AZAC (AZM46AC) EZSM4      AZMC (AZM46MC) EZSM6      AZAC (AZM66AC) EZSM6      AZMC (AZM66MC)
	EAS Series	EASM4      AZAC (AZM46AC) EASM4      AZMC (AZM46MC) EASM6      AZAC (AZM66AC) EASM6      AZMC (AZM66MC)







+

Product Line	Type	Product Name
Driver	Built-in Controller Type	AZD-AD, AZD-CD
	Pulse Input Type with RS-485 Communication	AZD-AX, AZD-CX
	Pulse Input Type	AZD-A, AZD-C
	EtherNet/IP-compatible	AZD-AEP, AZD-CEP
	EtherCAT Drive Profile-compatible	AZD-AED, AZD-CED
	PROFINET-compatible	AZD-APN, AZD-CPN























































+

Product Line	Type	Product Name
Connection Cable Sets/ Flexible Connection Cable Sets	Connection Cable Set	For motor/encoder: CC     VZF For motor/encoder/electromagnetic brake: CC     VZFB
	Flexible Connection Cable Sets	For motor/encoder: CC     VZR For motor/encoder/electromagnetic brake: CC     VZRB

● A number or letter indicating the following is specified where the symbol is located in the product name.

- : Motor installation direction or direction of air coupler for suction
- : Sensor rail
- : Table
- : Lead
- : Stroke
- : Cable length

























● DC Input

Product Line	Series	Product Name (On-board motor name)
Electric Linear Slides	EZS Series	EZSM3      AZAK (AZM46AK) EZSM3      AZMK (AZM46MK) EZSM4      AZAK (AZM46AK) EZSM4      AZMK (AZM46MK) EZSM6      AZAK (AZM66AK) EZSM6      AZMK (AZM66MK)
	EAS Series	EASM2      AZAK (AZM24AK) EASM4      AZAK (AZM46AK) EASM4      AZMK (AZM46MK) EASM6      AZAK (AZM66AK) EASM6      AZMK (AZM66MK)







+

Product Line	Type	Product Name
Driver	Built-in Controller Type	AZD-KD
	Pulse Input Type with RS-485 Communication	AZD-KX
	Pulse Input Type	AZD-K
	EtherNet/IP-compatible	AZD-KEP
	EtherCAT Drive Profile-compatible	AZD-KED
	PROFINET-compatible	AZD-KPN

+

Product Line	Type	Product Name	
Connection Cable Sets/ Flexible Connection Cable Sets	For EASM2	Connection Cable Set	CC     VZ2F2
		Flexible Connection Cable Sets	CC     VZ2R2
	For EZSM3 , EZSM4 , EZSM6 , EASM4 , EASM6	Connection Cable Set	For motor/encoder: CC     VZF2
			For motor/encoder/electromagnetic brake: CC     VZFB2
		Flexible Connection Cable Sets	For motor/encoder: CC     VZR2
			For motor/encoder/electromagnetic brake: CC     VZRB2

● A number or letter indicating the following is specified where the symbol is located in the product name.

- : Motor installation direction or direction of air coupler for suction
- : Sensor rail
- : Table
- : Lead
- : Stroke
- : Cable length

Electric Linear Slides

QSTEP AZ Series Equipped **EZS**

QSTEP AZ Series Equipped **EAS**

Electric Cylinders

QSTEP AZ Series Equipped **EAC**

Driver/Connection cable

Peripheral Equipment

How to Read Specifications

This is how to read specifications, using electric linear slide specifications as an example.

Electric Linear Slide Specifications

① Lead Screw Pitch	mm	12		6	
② Electromagnetic Brake (Power off activated type)		With	Blank	With	Blank
③ Drive Method		Ball Screw			
④ Repetitive Positioning Accuracy	mm	±0.02			
⑤ Minimum Traveling Amount	mm	0.01			
⑥ Traveling Parallelism	mm	0.03			
⑦ Permissible Moment	Dynamic Permissible Moment	M _P :16.3 M _V :4.8 M _R :15.0			
	Static Permissible Moment	M _P :58.3 M _V :16.0 M _R :53.3			
⑧ Transportable Mass	Horizontal	~15		~30	
	Vertical	~7	—	~14	—
⑨ Thrust	N	~70		~140	
⑩ Push Force	N	100		200	
⑪ Holding Force	N	70		140	
⑫ Maximum Speed by Stroke	50~500 mm	800		400	
	550 mm	650		320	
	600 mm	550		270	
	650 mm	460		220	
	700 mm	400		200	

● Depending on the product, there may be usage restrictions or precautions. Refer to the notes on each product's page for details.

① Lead

Distance the table moves in the linear direction in one motor rotation.

② Electromagnetic Brake (Power off activated type)

There are products with and without a power off activated type electromagnetic brake. Please select the type with an electromagnetic brake when driving in a vertical direction. (Except for **EASM2**)

③ Drive Method

This refers to the mechanism that converts rotation into linear motion.

④ Repetitive Positioning Accuracy

A value indicating the degree of error that generates when positioning is performed repeatedly to the same position in the same direction (measured at a constant temperature and under a constant load).

⑤ Minimum Traveling Amount

The minimum distance that a table can travel. (Factory setting)

⑥ Traveling Parallelism

The range of motion in the height and lateral directions from the electric linear slide's installation surface to the tabletop.

⑦ Permissible Moment

The load moment acts on the linear guide if the load's position is offset from the center of the table.

The direction of action applies to 3 directions: pitching (MP), yawing (MY), and rolling (MR), depending on the position of the offset. The dynamic permissible moment is the moment during operation. The static permissible moment is the moment while the motor is not moving.

⑧ Transportable Mass

● Horizontal direction

The maximum mass that can be moved under rated operating performance when using the electric linear slide horizontally.

● Vertical direction

The maximum mass that can be moved under rated operating performance when using the electric linear slide vertically.

⑨ Thrust

The thrusting force the table exerts on the load during constant speed operation.

⑩ Push Force

The pressure at push-motion operation.

⑪ Holding Force

The holding force in the power ON state when the motor is stopped and when the electromagnetic brake is activated.

⑫ Maximum Speed by Stroke

The maximum speed that the maximum transportable mass can be moved. The upper limit of speed is limited by the length of the stroke.

Electric
Linear
Slides

QSTEP
AZ Series
Equipped
EZS

QSTEP
AZ Series
Equipped
EAS

Electric
Cylinders

QSTEP
AZ Series
Equipped
EAC

Driver/
Connection
cable

Peripheral
Equipment

Electric Linear Slides

EZS Series α STEP AZ Series Equipped

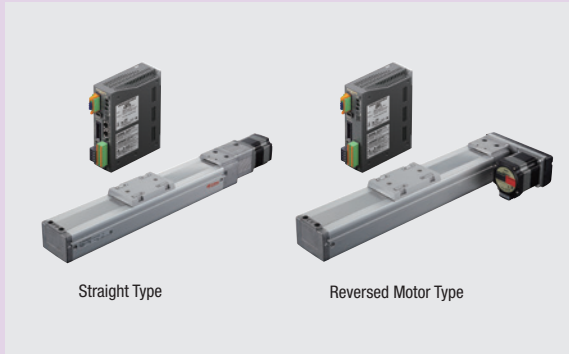

The **EZS** Series contains compact linear slides that are highly rigid and have a simple dust-resistant structure. Motors from the α STEP AZ Series are equipped. These electric linear slides can provide the unique advantages of stepper motors, such as high response, low vibration, and no hunting. Straight type and reversed motor type variations are available to match your installation space.

- High rigidity and compact guide
- Space saving by using reversed motors
- Simple dust-resistant structure prevent dust and other foreign objects from entering
- For cleanroom use

Features

Wide Variety of Products to Match Installation Spaces and Environments

Slim, high accuracy, and high strength slides and the product line includes reversed motor types with shorter overall length. Standard motors from the AZ Series are equipped. Various products are available.

Motor

α STEP AZ Series

- Built-in battery-free absolute sensor
- Positioning information is available without a sensor
- High reliability with closed loop control
- High efficiency technology reduces motor heat generation and saves energy



Built-in Controller Type

Pulse Input Type



Network Compatible

EtherNet/IP

EtherCAT

PROFINET

Electric Linear Slides

Straight Type



Reversed Motor Type
(Right side/left side)

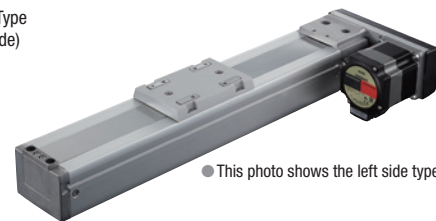

● This photo shows the left side type

For Cleanroom Use
(Suction joint right direction/
suction joint left direction)

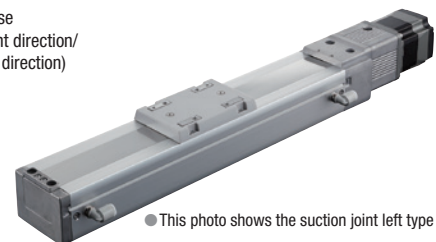

● This photo shows the suction joint left type

● This photo shows the **EZSM6** (width 74 mm × height 66.5 mm).



What is FLEX?

FLEX is the collective name for products that support I/O control, Modbus (RTU) control, and FA network control via network converters.

These products enable simple connection and simple control, shortening the total lead time for system construction.

High Rigidity & High Accuracy

Even with the compact motor, a high permissible moment is possible due to the rigidity of the guide.

● High Rigidity and High Accuracy Guide

The guides used are ball retainer equipped LM guides* made by THK. The slim stainless steel guide increases the load moment. The highly accurate guide also enables traveling parallelism of 0.03 mm or less.

*"Ball retainer" and "LM guide" are registered trademarks of THK Co., Ltd.

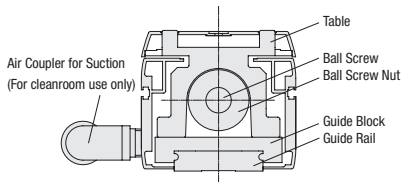

Traveling Parallelism 0.03 mm or Less

Slim Body with High Transportable Mass

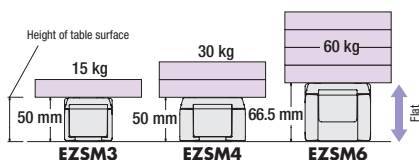

● High Permissible Moment

A high load moment is achieved from a compact body.

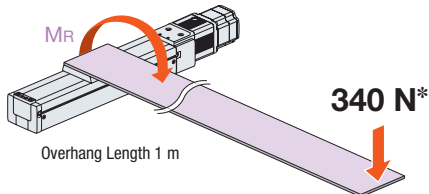

*The load value was calculated using the static permissible moment 340 Nm for **EZSM6**.

● Permissible Moment in the Rolling Direction [Nm]

Product Number	Static Permissible Moment*1	Dynamic Permissible Moment*2
EZSM3	52.0	10.5
EZSM4	176	27.8
EZSM6	340	55.6

*1 Load moment that the linear guide can support while the motor is stopped

*2 Load moment that the linear guide can support while the motor is in operation

Space Saving

Effective utilization of the installation space is possible because the body does not interfere with the loads. Installation in contact with another structure is possible.

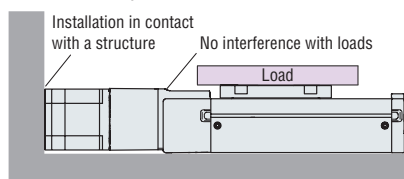

● Cable Outlet Can be Rotated

The motor can be rotated and installed in 4 possible directions*, so the direction of the cable outlet can be changed to match the installation location.

*Reversed motor type can be rotated in 3 possible directions.

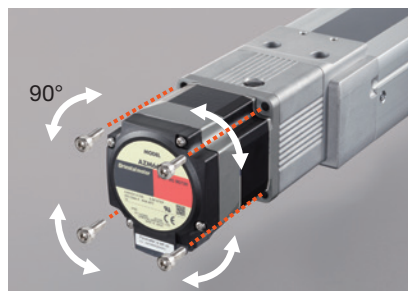

● Reversed Motor Type

The length of the reversed motor type is up to 136.4 mm shorter than the straight type. This contributes to space saving with equipment.

EZSM6 With Electromagnetic Brake Stroke 200 mm

● Straight Type

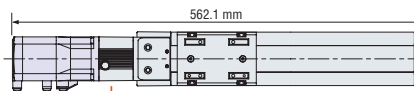

● Reversed Motor Type

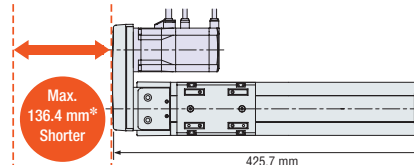

*With Electromagnetic Brake

Electric Linear Slides

QSTEP AZ Series Equipped **EZS**

QSTEP AZ Series Equipped **EAS**

Electric Cylinders

QSTEP AZ Series Equipped **EAC**

Driver/Connection cable

Peripheral Equipment

Simple Dust-proof Structure

The simple dust-resistant structure made from a stainless steel sheet and the roller mechanism in the table prevent dust and other foreign particles from entering.

Keeps Out Foreign Objects

Simple dust-resistant structure with stainless sheet prevents intrusion of foreign particles.

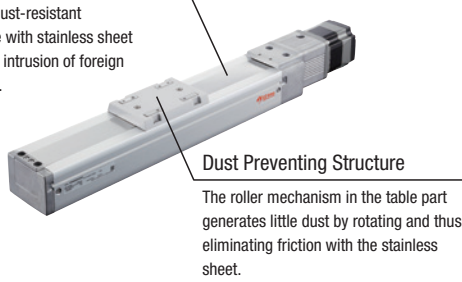

Low Dust-Generative Roller Mechanism (Patented)

The low dust-generative roller mechanism in the table rotates smoothly against the stainless sheet to prevent the generation of dust via friction. In addition to dust prevention, it increases the durability of the stainless sheet.

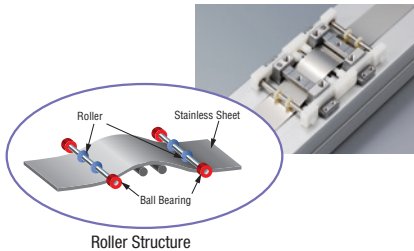

For Cleanroom Use

With the low dust-generative roller mechanism and clean grease, a clean degree meeting ISO Standard Class 3* (equivalent to FED Standard Class 1) has been achieved.

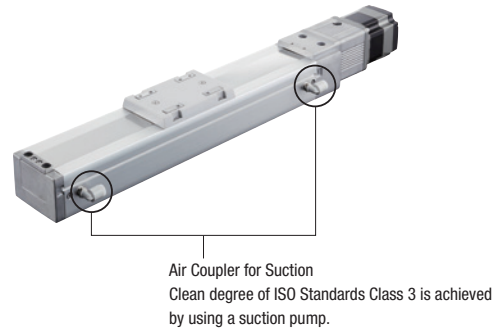

*ISO Standards Class 3
[ISO Standards Class 3]

Particle Diameter [μm]	0.1	0.3	0.5
Reduced Particulate Generation [Pieces/ m^3]	1000 max.	102 max.	35 max.

Uses Low Dust-generative Clean Grease

Low dust-generative clean grease is used on the ball screw, guides, bearing etc.

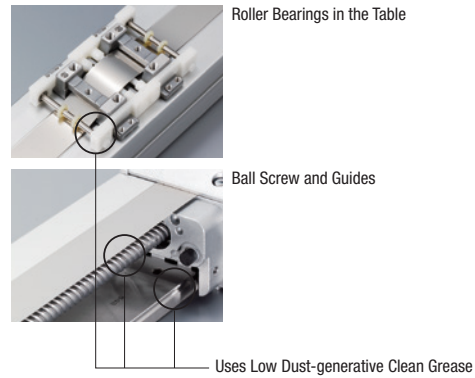

Clean Degree of Class 3 is Achieved with Minimum Suction

For example, **EZSM3** can achieve the clean degree of ISO Standards Class 3, when the internal suction volume is approximately 20 ℓ/min or more.

Correlation Diagram of Reduced Particulate Generation and Suction Volume

Example: **EZSM3CLD050/EZSM3CRD050**

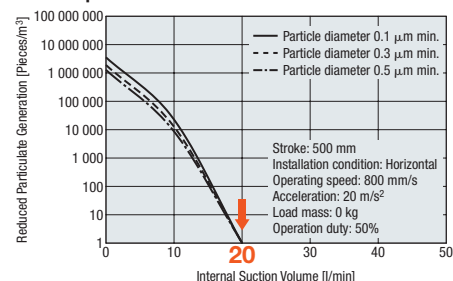

By minimizing amount of suction by the pump, power consumption can also be reduced.

Internal Suction Volume that Meets ISO Standards Class 3

Type	EZSM3	EZSM4	EZSM6
Internal Suction Volume [L/min]	20	30	30

For the correlation diagram of dust-generation and suction amount for **EZSM4** and **EZSM6**, refer to page 47.

High Speed Driving with Light Load or Heavy Load

High speed driving with a light load or heavy load can be achieved, even with inching operation.

<Product Used>
 Product Name: **EZSM6**
 Lead: 6 mm
 Input Type: 200 VAC

<Example operation>
 Load Mass: 15 kg
 Positioning Distance: 500 mm
 Drive Direction: Vertical

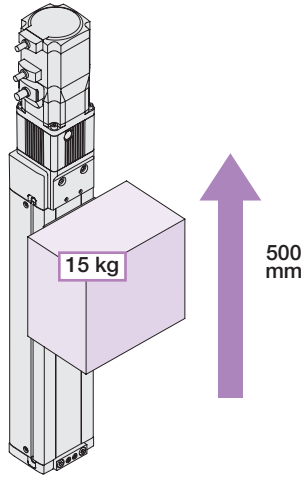

Electric Linear Slides

QSTEP AZ Series Equipped EZS

QSTEP AZ Series Equipped EAS

Electric Cylinders

QSTEP AZ Series Equipped EAC

Driver/Connection cable

Peripheral Equipment

High Speed Driving Even with a Heavy Load

High speed driving is possible, even if a heavy load is being transported vertically.

Load Mass: 15 kg
 Positioning Distance: 500 mm
 Positioning Time: 1.77 s
 Operating Speed: 320mm/s
 Acceleration: 1.5 m/s² (0.15 G)

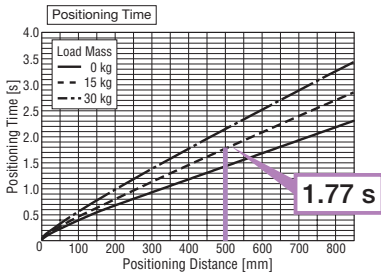

High Speed Driving Even with a Light Load

High speed driving is still possible, even with no load on the return trip.

Load Mass: 0 kg
 Positioning Distance: 500 mm
 Positioning Time: 1.4 s
 Operating Speed: 400mm/s
 Acceleration: 2 m/s² (0.2 G)

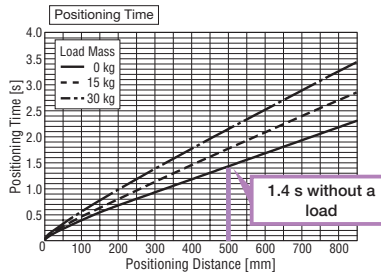

High Speed Driving Even in Inching Operation

High speed driving is still possible, even in inching operation with minute distances.

Load Mass: 15 kg
 Positioning Distance: 20 mm
 Positioning Time: 0.14 s
 Operating Speed: 200mm/s
 Acceleration: 4.7 m/s² (0.5 G)

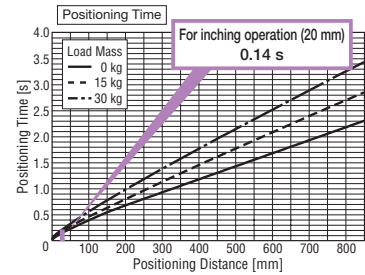

Product Line of Electric Linear Slides

● AC Input

◇ Product Number

① Model	② Motor Orientation	④ Lead Screw Pitch	⑤ Stroke	⑥ Equipped Motor	⑦ Motor Type	⑧ Motor Specifications
EZSM4	L	D	005	AZ	A	C
EZSM3 EZSM4 EZSM6	L: Reversed Motor Type (Left Side) R: Reversed Motor Type (Right Side) Blank: Straight Type	D: 12 mm E: 6 mm	005: 50 mm 010: 100 mm 015: 150 mm 085: 850 mm (50 mm increment)	AZ Series	A: Single Shaft M: With Electromagnetic Brake	C: AC Input Specifications

◇ **EZSM3** Straight Type / Reversed Motor Type

The prices are the same even if ② motor orientation (**L, R, Blank**), ④ lead screw pitch (**D, E**) are different.

⑦ Motor Type (A, M)	Single Shaft (A)	With Electromagnetic Brake (M)	
⑤ Stroke	50 mm (005)	695.00 €	868.00 €
	100 mm (010)	695.00 €	868.00 €
	150 mm (015)	719.00 €	894.00 €
	200 mm (020)	719.00 €	894.00 €
	250 mm (025)	744.00 €	918.00 €
	300 mm (030)	744.00 €	918.00 €
	350 mm (035)	769.00 €	943.00 €
	400 mm (040)	769.00 €	943.00 €
	450 mm (045)	794.00 €	967.00 €
	500 mm (050)	794.00 €	967.00 €
	550 mm (055)	819.00 €	993.00 €
	600 mm (060)	819.00 €	993.00 €
	650 mm (065)	843.00 €	1,018.00 €
	700 mm (070)	843.00 €	1,018.00 €

◇ **EZSM4** Straight Type / Reversed Motor Type

The prices are the same even if ② motor orientation (**L, R, Blank**), ④ lead screw pitch (**D, E**) are different.

⑦ Motor Type (A, M)	Single Shaft (A)	With Electromagnetic Brake (M)	
⑤ Stroke	50 mm (005)	732.00 €	906.00 €
	100 mm (010)	732.00 €	906.00 €
	150 mm (015)	756.00 €	931.00 €
	200 mm (020)	756.00 €	931.00 €
	250 mm (025)	781.00 €	955.00 €
	300 mm (030)	781.00 €	955.00 €
	350 mm (035)	807.00 €	981.00 €
	400 mm (040)	807.00 €	981.00 €
	450 mm (045)	831.00 €	1,005.00 €
	500 mm (050)	831.00 €	1,005.00 €
	550 mm (055)	856.00 €	1,030.00 €
	600 mm (060)	856.00 €	1,030.00 €
	650 mm (065)	880.00 €	1,055.00 €
	700 mm (070)	880.00 €	1,055.00 €

◇ **EZSM6** Straight Type / Reversed Motor Type

The prices are the same even if ② motor orientation (**L, R, Blank**), ④ lead screw pitch (**D, E**) are different.

⑦ Motor Type (A, M)	Single Shaft (A)	With Electromagnetic Brake (M)	
⑤ Stroke	50 mm (005)	984.00 €	1,208.00 €
	100 mm (010)	984.00 €	1,208.00 €
	150 mm (015)	1,009.00 €	1,232.00 €
	200 mm (020)	1,009.00 €	1,232.00 €
	250 mm (025)	1,033.00 €	1,258.00 €
	300 mm (030)	1,033.00 €	1,258.00 €
	350 mm (035)	1,059.00 €	1,282.00 €
	400 mm (040)	1,059.00 €	1,282.00 €
	450 mm (045)	1,084.00 €	1,307.00 €
	500 mm (050)	1,084.00 €	1,307.00 €
	550 mm (055)	1,108.00 €	1,333.00 €
	600 mm (060)	1,108.00 €	1,333.00 €
	650 mm (065)	1,133.00 €	1,357.00 €
	700 mm (070)	1,133.00 €	1,357.00 €
	750 mm (075)	1,158.00 €	1,382.00 €
	800 mm (080)	1,158.00 €	1,382.00 €
	850 mm (085)	1,183.00 €	1,407.00 €

● AC Input

◇ Product Number

① Model	③ Direction of Air Coupler for Suction*	④ Lead Screw Pitch	⑤ Stroke	⑥ Equipped Motor	⑦ Motor Type	⑧ Motor Specifications
EZSM4	CR	D	005	AZ	A	C
EZSM3 EZSM4 EZSM6	CL: Left Direction CR: Right Direction	D: 12 mm E: 6 mm	005: 50 mm 010: 100 mm 015: 150 mm 085: 850 mm (50 mm increment)	AZ Series	A: Single Shaft M: With Electromagnetic Brake	C: AC Input Specifications

*Only straight type is compatible for Cleanroom Use. For Cleanroom Use products, the direction of the air coupler for suction is required.

◇ EZSM3 For Cleanroom Use

The prices are the same even if the ③ direction of air coupler for suction (**CL, CR**), ④ lead screw pitch (**D, E**) are different.

⑦ Motor Type (A, M)	Single Shaft (A)	With Electromagnetic Brake (M)	
⑤ Stroke	50 mm (005)	819.00 €	993.00 €
	100 mm (010)	819.00 €	993.00 €
	150 mm (015)	843.00 €	1,018.00 €
	200 mm (020)	843.00 €	1,018.00 €
	250 mm (025)	868.00 €	1,042.00 €
	300 mm (030)	868.00 €	1,042.00 €
	350 mm (035)	894.00 €	1,067.00 €
	400 mm (040)	894.00 €	1,067.00 €
	450 mm (045)	918.00 €	1,093.00 €
	500 mm (050)	918.00 €	1,093.00 €
	550 mm (055)	943.00 €	1,117.00 €
	600 mm (060)	943.00 €	1,117.00 €
	650 mm (065)	967.00 €	1,142.00 €
	700 mm (070)	967.00 €	1,142.00 €

◇ EZSM4 For Cleanroom Use

The prices are the same even if the ③ direction of air coupler for suction (**CL, CR**), ④ lead screw pitch (**D, E**) are different.

⑦ Motor Type (A, M)	Single Shaft (A)	With Electromagnetic Brake (M)	
⑤ Stroke	50 mm (005)	856.00 €	1,030.00 €
	100 mm (010)	856.00 €	1,030.00 €
	150 mm (015)	880.00 €	1,055.00 €
	200 mm (020)	880.00 €	1,055.00 €
	250 mm (025)	906.00 €	1,080.00 €
	300 mm (030)	906.00 €	1,080.00 €
	350 mm (035)	931.00 €	1,105.00 €
	400 mm (040)	931.00 €	1,105.00 €
	450 mm (045)	955.00 €	1,129.00 €
	500 mm (050)	955.00 €	1,129.00 €
	550 mm (055)	981.00 €	1,154.00 €
	600 mm (060)	981.00 €	1,154.00 €
	650 mm (065)	1,005.00 €	1,180.00 €
	700 mm (070)	1,005.00 €	1,180.00 €

◇ EZSM6 For Cleanroom Use

The prices are the same even if the ③ direction of air coupler for suction (**CL, CR**), ④ lead screw pitch (**D, E**) are different.

⑦ Motor Type (A, M)	Single Shaft (A)	With Electromagnetic Brake (M)	
⑤ Stroke	50 mm (005)	1,108.00 €	1,333.00 €
	100 mm (010)	1,108.00 €	1,333.00 €
	150 mm (015)	1,133.00 €	1,357.00 €
	200 mm (020)	1,133.00 €	1,357.00 €
	250 mm (025)	1,158.00 €	1,382.00 €
	300 mm (030)	1,158.00 €	1,382.00 €
	350 mm (035)	1,183.00 €	1,407.00 €
	400 mm (040)	1,183.00 €	1,407.00 €
	450 mm (045)	1,208.00 €	1,432.00 €
	500 mm (050)	1,208.00 €	1,432.00 €
	550 mm (055)	1,232.00 €	1,457.00 €
	600 mm (060)	1,232.00 €	1,457.00 €
	650 mm (065)	1,258.00 €	1,481.00 €
	700 mm (070)	1,258.00 €	1,481.00 €
	750 mm (075)	1,282.00 €	1,506.00 €
	800 mm (080)	1,282.00 €	1,506.00 €
850 mm (085)	1,307.00 €	1,532.00 €	

● DC Input

◇ Product Number

① Model	② Motor Orientation	④ Lead Screw Pitch	⑤ Stroke	⑥ Equipped Motor	⑦ Motor Type	⑧ Motor Specifications
EZSM4	L	D	005	AZ	A	K
EZSM3 EZSM4 EZSM6	L: Reversed Motor Type (Left Side) R: Reversed Motor Type (Right Side) Blank: Straight Type	D: 12 mm E: 6 mm	005: 50 mm 010: 100 mm 015: 150 mm ~ 085: 850 mm (50 mm increment)	AZ Series	A: Single Shaft M: With Electromagnetic Brake	K: DC Input Specifications

◇ **EZSM3** Straight Type / Reversed Motor Type

The prices are the same even if ② motor orientation (**L, R, Blank**), ④ lead screw pitch (**D, E**) are different.

⑦ Motor Type (A, M)	Single Shaft (A)	With Electromagnetic Brake (M)	
⑤ Stroke	50 mm (005)	695.00 €	868.00 €
	100 mm (010)	695.00 €	868.00 €
	150 mm (015)	719.00 €	894.00 €
	200 mm (020)	719.00 €	894.00 €
	250 mm (025)	744.00 €	918.00 €
	300 mm (030)	744.00 €	918.00 €
	350 mm (035)	769.00 €	943.00 €
	400 mm (040)	769.00 €	943.00 €
	450 mm (045)	794.00 €	967.00 €
	500 mm (050)	794.00 €	967.00 €
	550 mm (055)	819.00 €	993.00 €
	600 mm (060)	819.00 €	993.00 €
	650 mm (065)	843.00 €	1,018.00 €
	700 mm (070)	843.00 €	1,018.00 €

◇ **EZSM4** Straight Type / Reversed Motor Type

The prices are the same even if ② motor orientation (**L, R, Blank**), ④ lead screw pitch (**D, E**) are different.

⑦ Motor Type (A, M)	Single Shaft (A)	With Electromagnetic Brake (M)	
⑤ Stroke	50 mm (005)	732.00 €	906.00 €
	100 mm (010)	732.00 €	906.00 €
	150 mm (015)	756.00 €	931.00 €
	200 mm (020)	756.00 €	931.00 €
	250 mm (025)	781.00 €	955.00 €
	300 mm (030)	781.00 €	955.00 €
	350 mm (035)	807.00 €	981.00 €
	400 mm (040)	807.00 €	981.00 €
	450 mm (045)	831.00 €	1,005.00 €
	500 mm (050)	831.00 €	1,005.00 €
	550 mm (055)	856.00 €	1,030.00 €
	600 mm (060)	856.00 €	1,030.00 €
	650 mm (065)	880.00 €	1,055.00 €
	700 mm (070)	880.00 €	1,055.00 €

◇ **EZSM6** Straight Type / Reversed Motor Type

The prices are the same even if ② motor orientation (**L, R, Blank**), ④ lead screw pitch (**D, E**) are different.

⑦ Motor Type (A, M)	Single Shaft (A)	With Electromagnetic Brake (M)	
⑤ Stroke	50 mm (005)	984.00 €	1,208.00 €
	100 mm (010)	984.00 €	1,208.00 €
	150 mm (015)	1,009.00 €	1,232.00 €
	200 mm (020)	1,009.00 €	1,232.00 €
	250 mm (025)	1,033.00 €	1,258.00 €
	300 mm (030)	1,033.00 €	1,258.00 €
	350 mm (035)	1,059.00 €	1,282.00 €
	400 mm (040)	1,059.00 €	1,282.00 €
	450 mm (045)	1,084.00 €	1,307.00 €
	500 mm (050)	1,084.00 €	1,307.00 €
	550 mm (055)	1,108.00 €	1,333.00 €
	600 mm (060)	1,108.00 €	1,333.00 €
	650 mm (065)	1,133.00 €	1,357.00 €
	700 mm (070)	1,133.00 €	1,357.00 €
	750 mm (075)	1,158.00 €	1,382.00 €
	800 mm (080)	1,158.00 €	1,382.00 €
	850 mm (085)	1,183.00 €	1,407.00 €

● DC Input

◇ Product Number

① Model	③ Direction of Air Coupler for Suction*	④ Lead Screw Pitch	⑤ Stroke	⑥ Equipped Motor	⑦ Motor Type	⑧ Motor Specifications
EZSM4	CR	D	005	AZ	A	K
EZSM3 EZSM4 EZSM6	CL: Left Direction CR: Right Direction	D: 12 mm E: 6 mm	005: 50 mm 010: 100 mm 015: 150 mm 085: 850 mm (50 mm increment)	AZ Series	A: Single Shaft M: With Electromagnetic Brake	K: DC Input Specifications

*Only straight type is compatible for Cleanroom Use. For Cleanroom Use products, the direction of the air coupler for suction is required.

◇ EZSM3 For Cleanroom Use

The prices are the same even if the ③ direction of air coupler for suction (**CL, CR**), ④ lead screw pitch (**D, E**) are different.

⑦ Motor Type (A, M)	Single Shaft (A)	With Electromagnetic Brake (M)	
⑤ Stroke	50 mm (005)	819.00 €	993.00 €
	100 mm (010)	819.00 €	993.00 €
	150 mm (015)	843.00 €	1,018.00 €
	200 mm (020)	843.00 €	1,018.00 €
	250 mm (025)	868.00 €	1,042.00 €
	300 mm (030)	868.00 €	1,042.00 €
	350 mm (035)	894.00 €	1,067.00 €
	400 mm (040)	894.00 €	1,067.00 €
	450 mm (045)	918.00 €	1,093.00 €
	500 mm (050)	918.00 €	1,093.00 €
	550 mm (055)	943.00 €	1,117.00 €
	600 mm (060)	943.00 €	1,117.00 €
	650 mm (065)	967.00 €	1,142.00 €
	700 mm (070)	967.00 €	1,142.00 €

◇ EZSM4 For Cleanroom Use

The prices are the same even if the ③ direction of air coupler for suction (**CL, CR**), ④ lead screw pitch (**D, E**) are different.

⑦ Motor Type (A, M)	Single Shaft (A)	With Electromagnetic Brake (M)	
⑤ Stroke	50 mm (005)	856.00 €	1,030.00 €
	100 mm (010)	856.00 €	1,030.00 €
	150 mm (015)	880.00 €	1,055.00 €
	200 mm (020)	880.00 €	1,055.00 €
	250 mm (025)	906.00 €	1,080.00 €
	300 mm (030)	906.00 €	1,080.00 €
	350 mm (035)	931.00 €	1,105.00 €
	400 mm (040)	931.00 €	1,105.00 €
	450 mm (045)	955.00 €	1,129.00 €
	500 mm (050)	955.00 €	1,129.00 €
	550 mm (055)	981.00 €	1,154.00 €
	600 mm (060)	981.00 €	1,154.00 €
	650 mm (065)	1,005.00 €	1,180.00 €
	700 mm (070)	1,005.00 €	1,180.00 €

◇ EZSM6 For Cleanroom Use

The prices are the same even if the ③ direction of air coupler for suction (**CL, CR**), ④ lead screw pitch (**D, E**) are different.

⑦ Motor Type (A, M)	Single Shaft (A)	With Electromagnetic Brake (M)	
⑤ Stroke	50 mm (005)	1,108.00 €	1,333.00 €
	100 mm (010)	1,108.00 €	1,333.00 €
	150 mm (015)	1,133.00 €	1,357.00 €
	200 mm (020)	1,133.00 €	1,357.00 €
	250 mm (025)	1,158.00 €	1,382.00 €
	300 mm (030)	1,158.00 €	1,382.00 €
	350 mm (035)	1,183.00 €	1,407.00 €
	400 mm (040)	1,183.00 €	1,407.00 €
	450 mm (045)	1,208.00 €	1,432.00 €
	500 mm (050)	1,208.00 €	1,432.00 €
	550 mm (055)	1,232.00 €	1,457.00 €
	600 mm (060)	1,232.00 €	1,457.00 €
	650 mm (065)	1,258.00 €	1,481.00 €
	700 mm (070)	1,258.00 €	1,481.00 €
	750 mm (075)	1,282.00 €	1,506.00 €
	800 mm (080)	1,282.00 €	1,506.00 €
850 mm (085)	1,307.00 €	1,532.00 €	

Included

Type	Included	Screws for Fixing	Operating Manual
Common to All Types	EZSM3, EZSM4 M5×45 P0.8 (4 pieces) EZSM6 M5×65 P0.8 (4 pieces)		1 Copy

The drivers and cables are the same as the ***α*STEP AZ Series**.

The drivers and cables to be combined with the actuators are the same as the ***α*STEP AZ Series**.

***α*STEP AZ Series** Brochure is available.

When selecting products, please also use the brochure.



System Configuration

- When an Electric Linear Slide with Electromagnetic Brake is Combined with a Built-in Controller Type Driver or with a Pulse Input Type Driver with RS-485 Communication

(The AC input and DC input are shown together. The product in the photograph is for AC input.)

An example of a configuration when I/O controlled using a built-in controller type driver or when controlled with RS-485 communication is shown below.

The electric linear slides, drivers, and connection cable sets/flexible connection cable sets must be ordered separately.

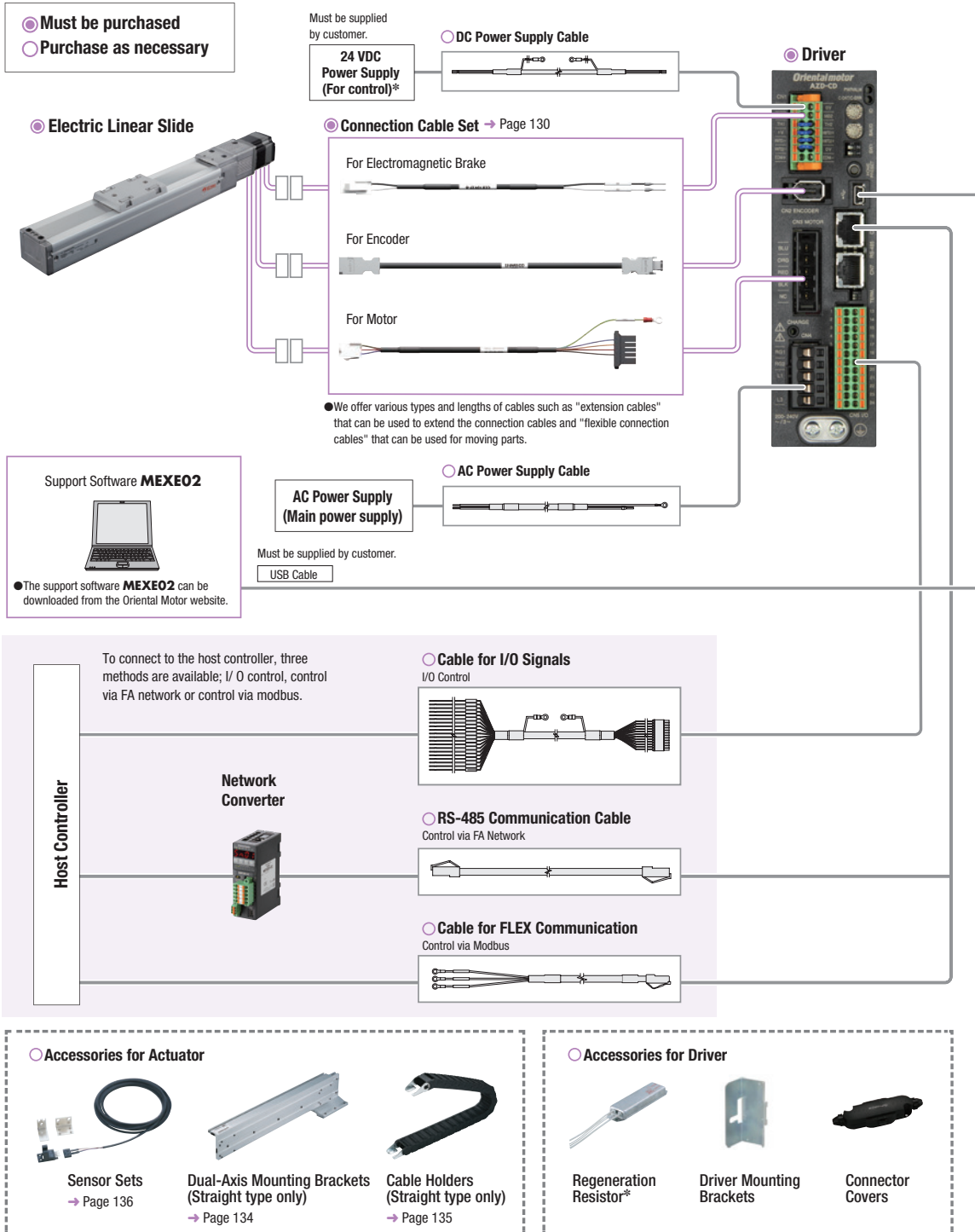

● When an Electric Linear Slide with Electromagnetic Brake is Combined with a Pulse Input Type Driver
(The AC input and DC input are shown together. The product in the photograph is for AC input.)

An example of a single-axis system configuration with the programmable controller (built-in pulse generator function) is shown below. The electric linear slides, drivers, and connection cable sets/flexible connection cable sets must be ordered separately.

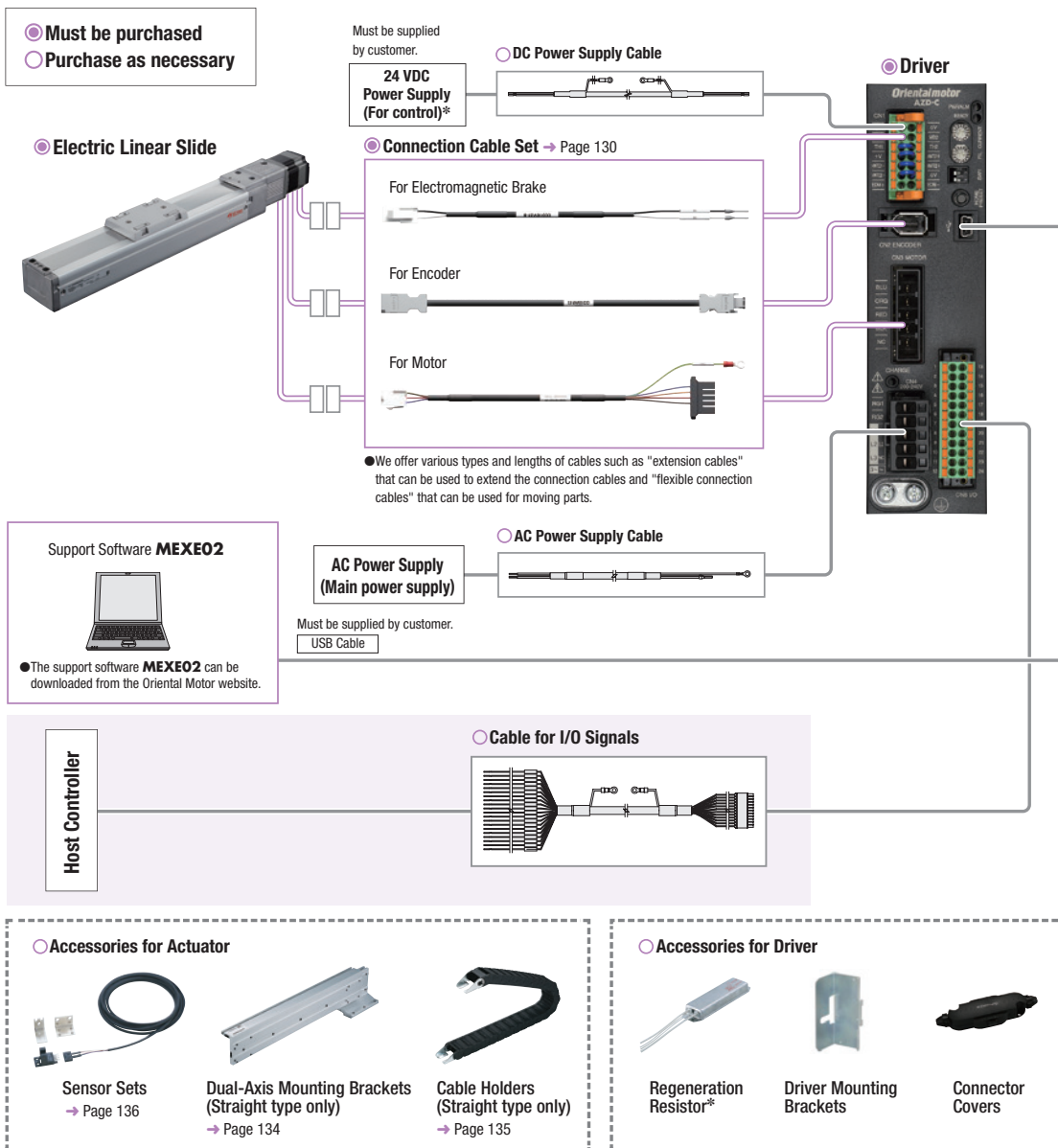

● Example of System Configuration Pricing

<p>Electric Linear Slide</p> <p>EZSM4D050AZMC</p> <p>1,005.00 €</p> <p>○</p>	+	<p>Driver</p> <p>AZD-C</p> <p>473.00 €</p> <p>○</p>	+	<p>Cables</p> <p>Connection Cable Set (1 m)</p> <p>CC010VZFB</p> <p>46.00 €</p> <p>○</p>
---	---	--	---	---

● The system configuration shown above is an example. Other combinations are also available.

Note

● The motor cable and electromagnetic brake cable from the motor cannot be connected directly to the driver. When connecting to a driver, use a connection cable.

● When an Electric Linear Slide with Electromagnetic Brake is Combined with a Network Compatible Driver
(The AC input and DC input are shown together. The product in the photograph is for AC input.)

An example of a configuration when I/O controlled using an PROFINET Compatible driver or when controlled with PROFINET is shown below.

The electric linear slides, drivers, and connection cable sets/flexible connection cable sets must be ordered separately.

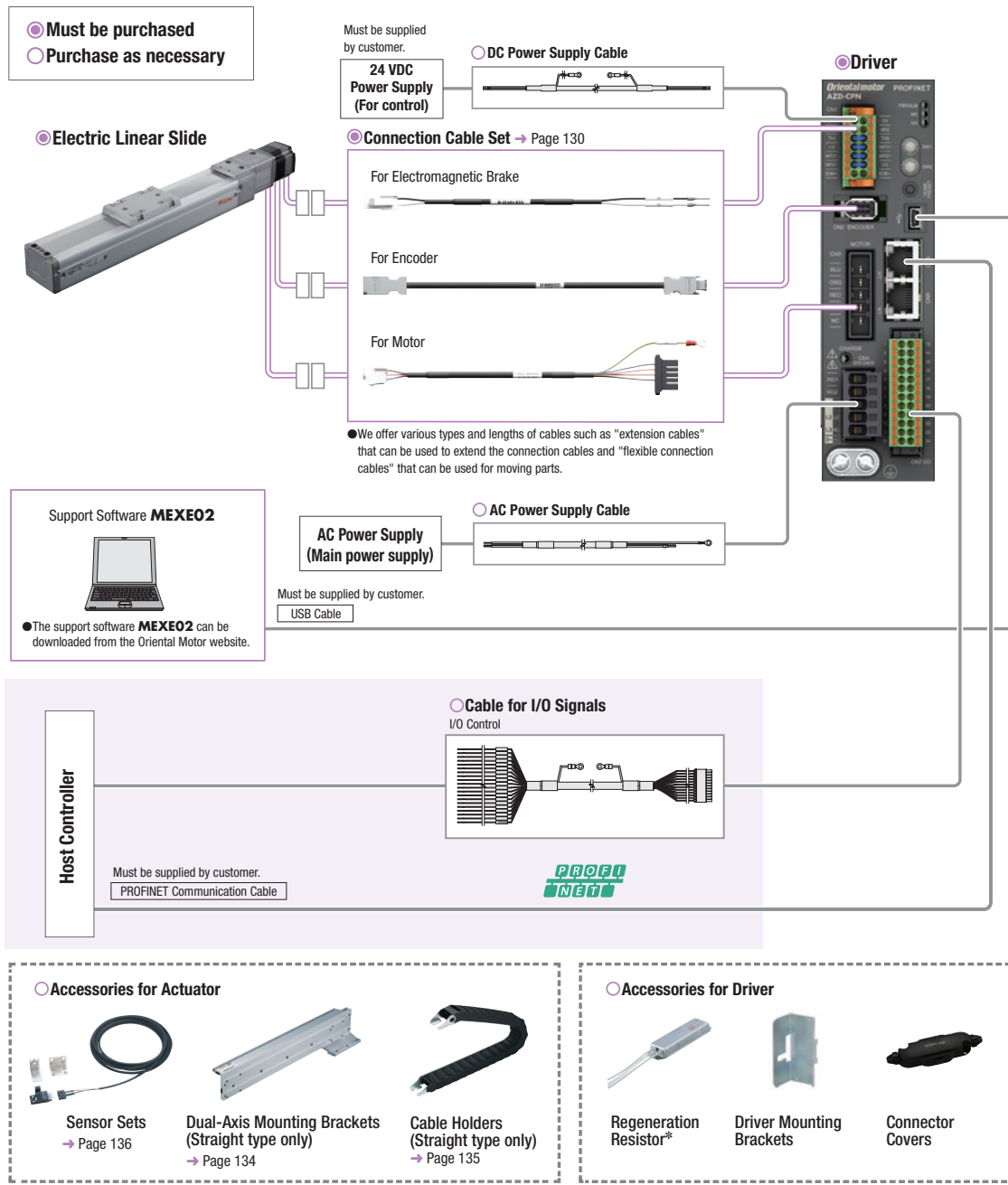

*Not required for the DC input products.

● Example of System Configuration Pricing

Electric Linear Slide EZSM4D050AZMC 1,005.00 €	+	Driver AZD-CEP 572.00 €	+	Cables Connection Cable Set (1 m) CC010VZFB 46.00 €
---	---	--------------------------------------	---	---

● The system configuration shown above is an example. Other combinations are also available.

Note

● The motor cable and electromagnetic brake cable from the motor cannot be connected directly to the driver. When connecting to a driver, use a connection cable.

EZSM3: Width 54 mm × Height 50 mm Straight Type / Reversed Motor Type / AC Input For Cleanroom Use

Product Number

Model	Motor Orientation*1	Direction of Air Coupler for Suction*2	Lead Screw Pitch	Stroke	Equipped Motor	Motor Type	Motor Specifications
EZSM3		CR	D	005	AZ	A	C
EZSM3	L: Reversed Motor Type (Left Side) R: Reversed Motor Type (Right Side) Blank: Straight Type	CL: Left Direction CR: Right Direction	D: 12 mm E: 6 mm	005: 50 mm 010: 100 mm 015: 150 mm ~ 070: 700 mm (50 mm increment)	AZ Series	A: Single Shaft M: With Electromagnetic Brake	C: AC Input Specifications

*1 Only straight type is compatible for Cleanroom Use.

*2 For Cleanroom Use products, the direction of the air coupler for suction is required.

Electric Linear Slide Specifications

Lead Screw Pitch	mm	12	6
Electromagnetic Brake (Power off activated type)		Equipped	Not equipped
Drive Method		Ball Screw	
Repetitive Positioning Accuracy	mm	±0.02	
Minimum Travel Amount	mm	0.01	
Traveling Parallelism	mm	0.03	
Permissible Moment	Dynamic Permissible Moment	M _r :4.2 M _v :4.2 M _s :10.5	
	Static Permissible Moment	M _r :26.4 M _v :26.4 M _s :52.0	
Transportable Mass	Horizontal	7.5 max.	15 max.
	Vertical	3.5 max.	7 max.
Thrust	N	43 max.	86 max.
Push Force	N	100	200
Holding Force		70	140 [125]
	50 to 500 mm	800	400
Maximum Speed by Stroke	550 mm	650	320
	600 mm	550	270
	650 mm	460	220
	700 mm	400	200

● The brackets [] indicate the value of the reversed motor type.

● Since the holding force is lost when the power is not supplied, the load and external force cannot be held in the vertical direction. Select a product with an electromagnetic brake for operation in the vertical direction.

Positioning Distance – Positioning Time

The positioning time (reference) can be checked from the positioning distance.

A reference value for the positioning time can be calculated by multiplying the positioning time calculated from the graph with the positioning time coefficient for the applicable stroke.

Lead Screw Pitch 12 mm

Horizontal Direction Installation

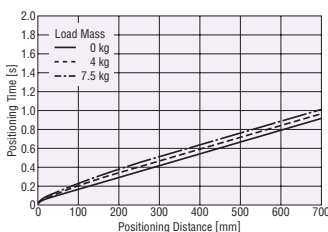

Vertical Direction Installation

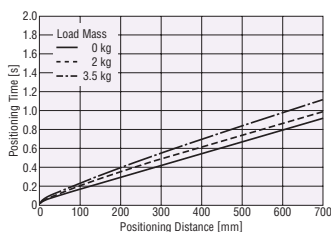

Lead Screw Pitch 6 mm

Horizontal Direction Installation

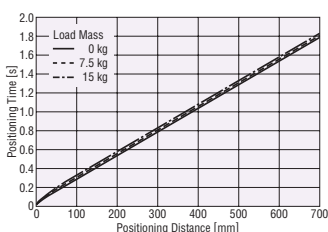

Vertical Direction Installation

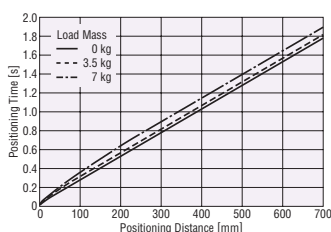

Note

● The starting speed should be 6 mm/s or less.

Dimensions Electric Linear Slides → Page 39, 40

Operating Speed – Load Mass

Horizontal Direction Installation (Acceleration 3 m/s²)

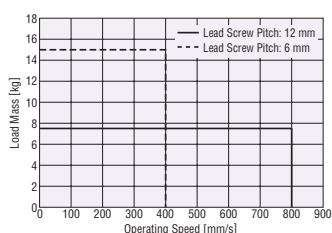

Vertical Direction Installation (Acceleration 2 m/s²)

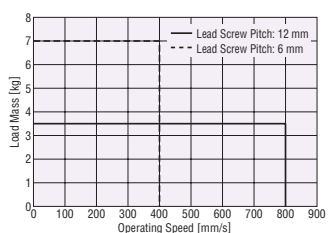

Positioning Time Coefficient

Stroke [mm]	Load Mass					
	Horizontal Direction Installation			Vertical Direction Installation		
	0 kg	4 kg	7.5 kg	0 kg	2 kg	3.5 kg
50 to 500	1.0	1.0	1.0	1.0	1.0	1.0
550	1.2	1.2	1.1	1.2	1.1	1.0
600	1.4	1.3	1.3	1.4	1.3	1.2
650	1.7	1.6	1.5	1.7	1.6	1.4
700	1.9	1.8	1.8	1.9	1.8	1.6

Positioning Time Coefficient

Stroke [mm]	Load Mass					
	Horizontal Direction Installation			Vertical Direction Installation		
	0 kg	7.5 kg	15 kg	0 kg	3.5 kg	7 kg
50 to 500	1.0	1.0	1.0	1.0	1.0	1.0
550	1.2	1.2	1.2	1.2	1.2	1.2
600	1.5	1.4	1.4	1.5	1.4	1.4
650	1.8	1.8	1.7	1.8	1.8	1.7
700	2.0	1.9	1.9	2.0	1.9	1.9

EZSM3: Width 54 mm × Height 50 mm Straight Type / Reversed Motor Type / For Cleanroom Use DC Input

Electric Linear Slides

Q-STEP AZ Series Equipped EZS

Q-STEP AZ Series Equipped EAS

Electric Cylinders

Q-STEP AZ Series Equipped EAC

Driver/Connection cable

Peripheral Equipment

Product Number

Model	Motor Orientation*1	Direction of Air Coupler for Suction*2	Lead Screw Pitch	Stroke	Equipped Motor	Motor Type	Motor Specifications
EZSM3		CR	D	005	AZ	A	K
EZSM3	L: Reversed Motor Type (Left Side) R: Reversed Motor Type (Right Side) Blank: Straight Type	CL: Left Direction CR: Right Direction	D: 12 mm E: 6 mm	005: 50 mm 010: 100 mm 015: 150 mm ~ 070: 700 mm (50 mm increment)	AZ Series	A: Single Shaft M: With Electromagnetic Brake	K: DC Input Specifications

*1 Only straight type is compatible for Cleanroom Use.

*2 For Cleanroom Use products, the direction of the air coupler for suction is required.

Electric Linear Slide Specifications

Lead Screw Pitch	mm	12	6
Electromagnetic Brake (Power off activated type)		Equipped	Not equipped
Drive Method		Ball Screw	
Repetitive Positioning Accuracy	mm	±0.02	
Minimum Travel Amount	mm	0.01	
Traveling Parallelism	mm	0.03	
Permissible Moment	Dynamic Permissible Moment	M _r :4.2 M _v :4.2 M _s :10.5	
	Static Permissible Moment	M _r :26.4 M _v :26.4 M _s :52.0	
Transportable Mass	Horizontal	7.5 max.	15 max.
	Vertical	3.5 max.	7 max.
Thrust	N	43 max.	86 max.
Push Force	N	100	200
Holding Force	N	70	140 [125]
Maximum Speed by Stroke	50 to 550 mm	600	300
	600 mm	550	270
	650 mm	460	220
	700 mm	400	200

- The brackets [] indicate the value of the reversed motor type.
- For the specifications and characteristics of 48 VDC input, please contact the nearest Oriental Motor sales office.
- Since the holding force is lost when the power is not supplied, the load and external force cannot be held in the vertical direction. Select a product with an electromagnetic brake for operation in the vertical direction.
- The maximum speed may be lower depending on the ambient temperature and the length of the motor cable.

Operating Speed – Load Mass

● Horizontal Direction Installation (Acceleration 3 m/s²)

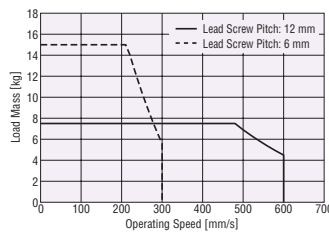

● Vertical Direction Installation (Acceleration 2 m/s²)

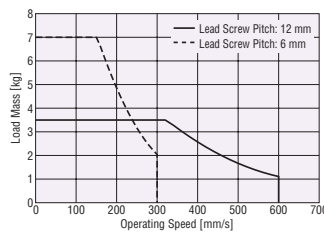

Positioning Distance – Positioning Time

The positioning time (reference) can be checked from the positioning distance.

A reference value for the positioning time can be calculated by multiplying the positioning time calculated from the graph with the positioning time coefficient for the applicable stroke.

● Lead Screw Pitch 12 mm

◇ Horizontal Direction Installation

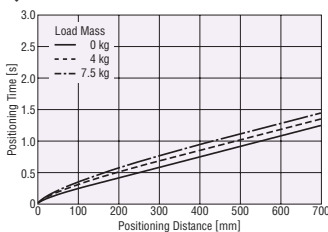

◇ Vertical Direction Installation

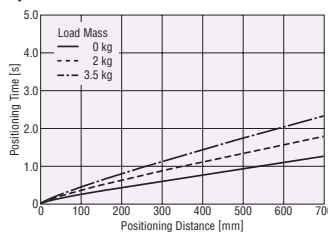

Positioning Time Coefficient

Stroke [mm]	Load Mass					
	Horizontal Direction Installation			Vertical Direction Installation		
	0 kg	4 kg	7.5 kg	0 kg	2 kg	3.5 kg
50 to 550	1.0	1.0	1.0	1.0	1.0	1.0
600	1.1	1.0	1.0	1.1	1.0	1.0
650	1.2	1.2	1.1	1.2	1.0	1.0
700	1.4	1.3	1.3	1.4	1.0	1.0

● Lead Screw Pitch 6 mm

◇ Horizontal Direction Installation

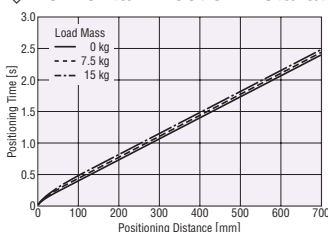

◇ Vertical Direction Installation

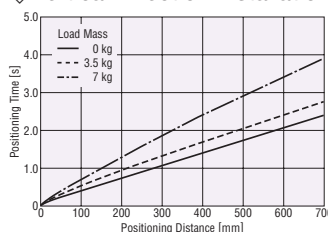

Positioning Time Coefficient

Stroke [mm]	Load Mass					
	Horizontal Direction Installation			Vertical Direction Installation		
	0 kg	7.5 kg	15 kg	0 kg	3.5 kg	7 kg
50 to 550	1.0	1.0	1.0	1.0	1.0	1.0
600	1.1	1.1	1.1	1.1	1.0	1.0
650	1.3	1.3	1.3	1.3	1.2	1.0
700	1.5	1.5	1.4	1.5	1.3	1.0

Note

- The starting speed should be 6 mm/s or less.

Dimensions Electric Linear Slides → Page 39, 40

EZSM4: Width 74 mm × Height 50 mm

Straight Type / For Cleanroom Use AC Input

Product Number

Model	Direction of Air Coupler for Suction*	Lead Screw Pitch	Stroke	Equipped Motor	Motor Type	Motor Specifications
EZSM4	CR	D	005	AZ	A	C
EZSM4	CL: Left Direction CR: Right Direction	D: 12 mm E: 6 mm	005: 50 mm 010: 100 mm 015: 150 mm ~ 070: 700 mm (50 mm increment)	AZ Series	A: Single Shaft M: With Electromagnetic Brake	C: AC Input Specifications

*Only straight type is compatible for Cleanroom Use. For Cleanroom Use products, the direction of the air coupler for suction is required.

Electric Linear Slide Specifications

Lead Screw Pitch	mm	12	6		
Electromagnetic Brake (Power off activated type)		Equipped	Not equipped	Equipped	Not equipped
Drive Method		Ball Screw			
Repetitive Positioning Accuracy	mm	±0.02			
Minimum Travel Amount	mm	0.01			
Traveling Parallelism	mm	0.03			
Permissible Moment	Dynamic Permissible Moment	M _p :8.0 M _v :8.0 M _a :27.8			
	Static Permissible Moment	M _p :51.2 M _v :42.5 M _a :176.0			
Transportable Mass	Horizontal	15 max.		30 max.	
	Vertical	7 max.	—	14 max.	—
Thrust	N	70 max.		140 max.	
Push Force	N	100		200	
Holding Force	N	70		140	
Maximum Speed by Stroke	50 to 500 mm	800		400	
	550 mm	650		320	
	600 mm	550		270	
	650 mm	460		220	
	700 mm	400		200	

● Since the holding force is lost when the power is not supplied, the load and external force cannot be held in the vertical direction. Select a product with an electromagnetic brake for operation in the vertical direction.

Operating Speed – Load Mass

● Horizontal Direction Installation (Acceleration 3 m/s²)

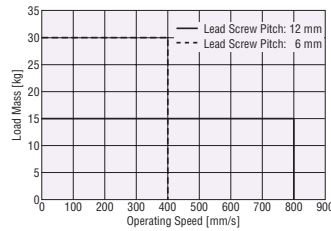

● Vertical Direction Installation (Acceleration 2 m/s²)

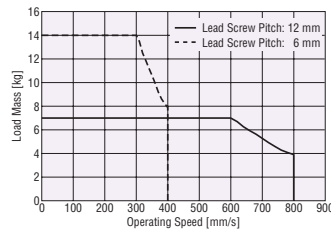

Positioning Distance – Positioning Time

The positioning time (reference) can be checked from the positioning distance.

A reference value for the positioning time can be calculated by multiplying the positioning time calculated from the graph with the positioning time coefficient for the applicable stroke.

● Lead Screw Pitch 12 mm

◇ Horizontal Direction Installation

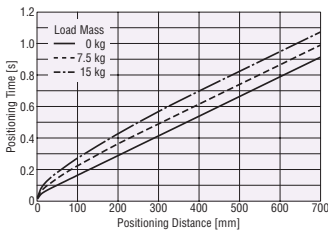

◇ Vertical Direction Installation

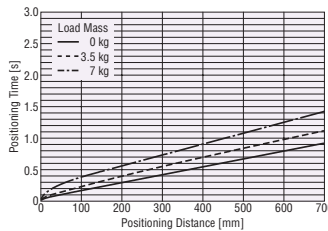

Positioning Time Coefficient

Stroke [mm]	Load Mass					
	Horizontal Direction Installation			Vertical Direction Installation		
	0 kg	7.5 kg	15 kg	0 kg	3.5 kg	7 kg
50 to 500	1.0	1.0	1.0	1.0	1.0	1.0
550	1.2	1.1	1.1	1.2	1.0	1.0
600	1.4	1.3	1.2	1.4	1.2	1.0
650	1.7	1.5	1.4	1.7	1.4	1.2
700	1.9	1.8	1.6	1.9	1.6	1.3

● Lead Screw Pitch 6 mm

◇ Horizontal Direction Installation

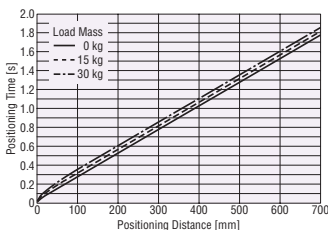

◇ Vertical Direction Installation

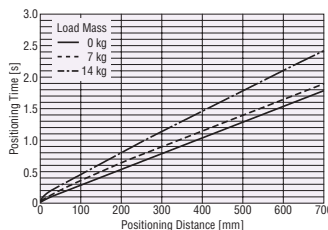

Positioning Time Coefficient

Stroke [mm]	Load Mass					
	Horizontal Direction Installation			Vertical Direction Installation		
	0 kg	15 kg	30 kg	0 kg	7 kg	14 kg
50 to 500	1.0	1.0	1.0	1.0	1.0	1.0
550	1.2	1.2	1.2	1.2	1.2	1.0
600	1.5	1.4	1.4	1.5	1.4	1.1
650	1.8	1.7	1.7	1.8	1.7	1.3
700	2.0	1.9	1.9	2.0	1.9	1.5

Note

● The starting speed should be 6 mm/s or less.

Dimensions Electric Linear Slides → Page 41

EZSM4: Width 74 mm×Height 50 mm Reversed Motor Type AC Input

Electric Linear Slides

QSTEP AZ Series Equipped EZS

QSTEP AZ Series Equipped EAS

Electric Cylinders

QSTEP AZ Series Equipped EAC

Driver/Connection cable

Peripheral Equipment

Product Number

Model	Motor Orientation	Lead Screw Pitch	Stroke	Equipped Motor	Motor Type	Motor Specifications
EZSM4	D	005	AZ	A	C	
EZSM4	L: Reversed Motor Type (Left Side) R: Reversed Motor Type (Right Side)	D: 12 mm E: 6 mm	005: 50 mm 010: 100 mm 015: 150 mm ~ 070: 700 mm (50 mm increment)	AZ Series	A: Single Shaft M: With Electromagnetic Brake	C: AC Input Specifications

Electric Linear Slide Specifications

Lead Screw Pitch	mm	12	6
Electromagnetic Brake (Power off activated type)		Equipped	Not equipped
Drive Method		Ball Screw	
Repetitive Positioning Accuracy	mm	±0.02	
Minimum Travel Amount	mm	0.01	
Traveling Parallelism	mm	0.03	
Permissible Moment	Dynamic Permissible Moment	M _p :8.0 M _v :8.0 M _a :27.8	
	Static Permissible Moment	M _p :51.2 M _v :42.5 M _a :176.0	
Transportable Mass	Horizontal	15 max.	30 max.
	Vertical	7 max.	12.5 max.
Thrust	N	70 max.	125 max.
Push Force	N	100	200
Holding Force	N	70	125
Maximum Speed by Stroke	50 to 500 mm	800	400
	550 mm	650	320
	600 mm	550	270
	650 mm	460	220
	700 mm	400	200

● Since the holding force is lost when the power is not supplied, the load and external force cannot be held in the vertical direction. Select a product with an electromagnetic brake for operation in the vertical direction.

Operating Speed – Load Mass

Horizontal Direction Installation (Acceleration 3 m/s²)

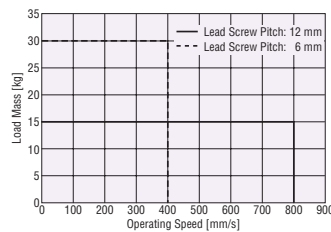

Vertical Direction Installation (Acceleration 2 m/s²)

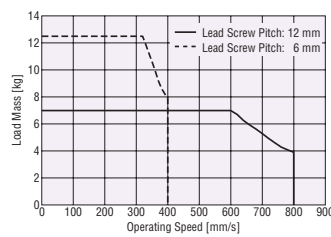

Positioning Distance – Positioning Time

The positioning time (reference) can be checked from the positioning distance.

A reference value for the positioning time can be calculated by multiplying the positioning time calculated from the graph with the positioning time coefficient for the applicable stroke.

Lead Screw Pitch 12 mm

Horizontal Direction Installation

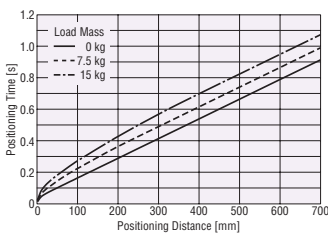

Vertical Direction Installation

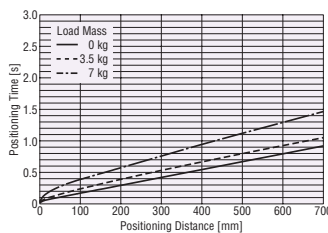

Positioning Time Coefficient

Stroke [mm]	Load Mass					
	Horizontal Direction Installation			Vertical Direction Installation		
	0 kg	7.5 kg	15 kg	0 kg	3.5 kg	7 kg
50 to 500	1.0	1.0	1.0	1.0	1.0	1.0
550	1.2	1.1	1.1	1.2	1.0	1.0
600	1.4	1.3	1.2	1.4	1.2	1.0
650	1.7	1.5	1.4	1.7	1.4	1.2
700	1.9	1.8	1.6	1.9	1.6	1.3

Lead Screw Pitch 6 mm

Horizontal Direction Installation

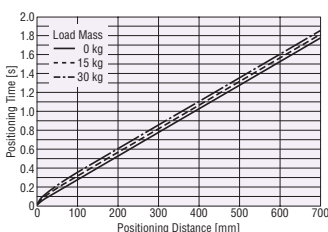

Vertical Direction Installation

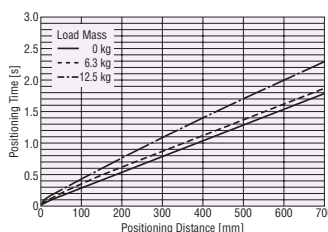

Positioning Time Coefficient

Stroke [mm]	Load Mass					
	Horizontal Direction Installation			Vertical Direction Installation		
	0 kg	15 kg	30 kg	0 kg	6.3 kg	12.5 kg
50 to 500	1.0	1.0	1.0	1.0	1.0	1.0
550	1.2	1.2	1.2	1.2	1.2	1.0
600	1.5	1.4	1.4	1.5	1.4	1.2
650	1.8	1.7	1.7	1.8	1.7	1.4
700	2.0	1.9	1.9	2.0	1.9	1.6

Note

● The starting speed should be 6 mm/s or less.

Dimensions Electric Linear Slides → Page 42

EZSM4: Width 74 mm × Height 50 mm

Straight Type / For Cleanroom Use DC Input

Product Number

Model	Direction of Air Coupler for Suction*	Lead Screw Pitch	Stroke	Equipped Motor	Motor Type	Motor Specifications
EZSM4	CR	D	005	AZ	A	K
EZSM4	CL: Left Direction CR: Right Direction	D: 12 mm E: 6 mm	005: 50 mm 010: 100 mm 015: 150 mm ~ 070: 700 mm (50 mm increment)	AZ Series	A: Single Shaft M: With Electromagnetic Brake	K: DC Input Specifications

*Only straight type is compatible for Cleanroom Use. For Cleanroom Use products, the direction of the air coupler for suction is required.

Electric Linear Slide Specifications

Lead Screw Pitch	mm	12	6
Electromagnetic Brake (Power off activated type)		Equipped	Not equipped
Drive Method		Equipped	Not equipped
Repetitive Positioning Accuracy	mm	Ball Screw	
Minimum Travel Amount	mm	±0.02	
Traveling Parallelism	mm	0.01	
Permissible Moment	Dynamic Permissible Moment	Nm	
	Static Permissible Moment	M _r :8.0 M _v :8.0 M _n :27.8	
Transportable Mass	Horizontal	kg	M _r :51.2 M _v :42.5 M _n :176.0
	Vertical	kg	15 max. 30 max.
Thrust	N	7 max. 14 max.	70 max. 140 max.
Push Force	N	70	100 200
Holding Force	N	70	140
Maximum Speed by Stroke	50 to 550 mm	mm/s	600 300
	600 mm	mm/s	550 270
	650 mm	mm/s	460 220
	700 mm	mm/s	400 200

- For the specifications and characteristics of 48 VDC input, please contact the nearest Oriental Motor sales office.
- Since the holding force is lost when the power is not supplied, the load and external force cannot be held in the vertical direction. Select a product with an electromagnetic brake for operation in the vertical direction.
- The maximum speed may be lower depending on the ambient temperature and the length of the motor cable.

Positioning Distance – Positioning Time

The positioning time (reference) can be checked from the positioning distance.

A reference value for the positioning time can be calculated by multiplying the positioning time calculated from the graph with the positioning time coefficient for the applicable stroke.

Lead Screw Pitch 12 mm

Horizontal Direction Installation

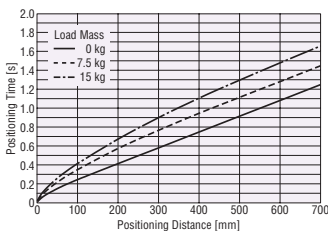

Vertical Direction Installation

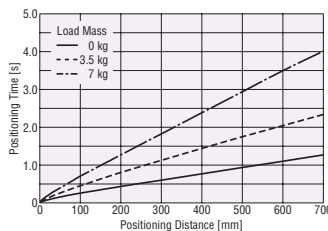

Positioning Time Coefficient

Stroke [mm]	Load Mass					
	Horizontal Direction Installation			Vertical Direction Installation		
	0 kg	7.5 kg	15 kg	0 kg	3.5 kg	7 kg
50 to 550	1.0	1.0	1.0	1.0	1.0	1.0
600	1.1	1.0	1.0	1.1	1.0	1.0
650	1.2	1.1	1.1	1.2	1.0	1.0
700	1.4	1.3	1.2	1.4	1.0	1.0

Lead Screw Pitch 6 mm

Horizontal Direction Installation

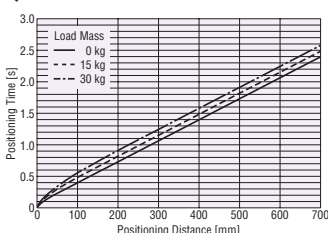

Vertical Direction Installation

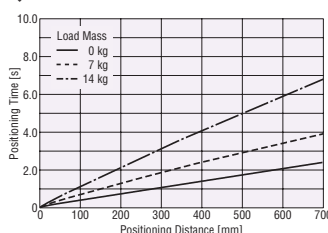

Positioning Time Coefficient

Stroke [mm]	Load Mass					
	Horizontal Direction Installation			Vertical Direction Installation		
	0 kg	15 kg	30 kg	0 kg	7 kg	14 kg
50 to 550	1.0	1.0	1.0	1.0	1.0	1.0
600	1.1	1.1	1.1	1.1	1.0	1.0
650	1.3	1.3	1.3	1.3	1.0	1.0
700	1.5	1.4	1.4	1.5	1.0	1.0

Note

- The starting speed should be 6 mm/s or less.

Dimensions Electric Linear Slides → Page 41

EZSM4: Width 74 mm×Height 50 mm Reversed Motor Type DC Input

Electric Linear Slides

QSTEP AZ Series Equipped EZS

QSTEP AZ Series Equipped EAS

Electric Cylinders

QSTEP AZ Series Equipped EAC

Driver/ Connection cable

Peripheral Equipment

Product Number

Model	Motor Orientation	Lead Screw Pitch	Stroke	Equipped Motor	Motor Type	Motor Specifications
EZSM4		D	005	AZ	A	K
EZSM4	L: Reversed Motor Type (Left Side) R: Reversed Motor Type (Right Side)	D: 12 mm E: 6 mm	005: 50 mm 010: 100 mm 015: 150 mm ~ 070: 700 mm (50 mm increment)	AZ Series	A: Single Shaft M: With Electromagnetic Brake	K: DC Input Specifications

Electric Linear Slide Specifications

Lead Screw Pitch	mm	12	6
Electromagnetic Brake (Power off activated type)		Equipped	Not equipped
Drive Method		Ball Screw	
Repetitive Positioning Accuracy	mm	±0.02	
Minimum Travel Amount	mm	0.01	
Traveling Parallelism	mm	0.03	
Permissible Moment	Dynamic Permissible Moment	M _D :8.0 M _V :8.0 M _R :27.8	
	Static Permissible Moment	M _S :51.2 M _V :42.5 M _R :176.0	
Transportable Mass	Horizontal	15 max.	30 max.
	Vertical	7 max.	12.5 max.
Thrust	N	70 max.	125 max.
Push Force	N	100	200
Holding Force	N	70	125
Maximum Speed by Stroke	50 to 550 mm	600	300
	600 mm	550	270
	650 mm	460	220
	700 mm	400	200

- For the specifications and characteristics of 48 VDC input, please contact the nearest Oriental Motor sales office.
- Since the holding force is lost when the power is not supplied, the load and external force cannot be held in the vertical direction. Select a product with an electromagnetic brake for operation in the vertical direction.
- The maximum speed may be lower depending on the ambient temperature and the length of the motor cable.

Operating Speed – Load Mass

Horizontal Direction Installation (Acceleration 3 m/s²)

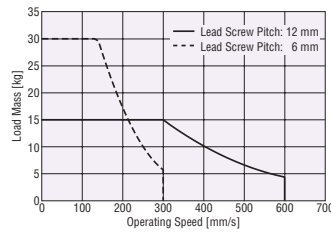

Vertical Direction Installation (Acceleration 2 m/s²)

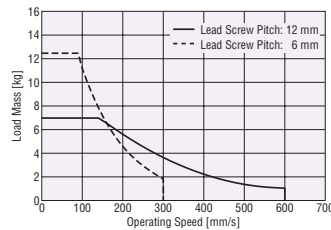

Positioning Distance – Positioning Time

The positioning time (reference) can be checked from the positioning distance.

A reference value for the positioning time can be calculated by multiplying the positioning time calculated from the graph with the positioning time coefficient for the applicable stroke.

● Lead Screw Pitch 12 mm

◇ Horizontal Direction Installation

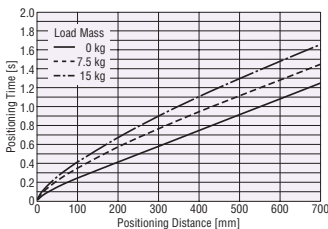

◇ Vertical Direction Installation

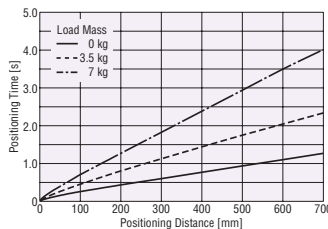

Positioning Time Coefficient

Stroke [mm]	Load Mass					
	Horizontal Direction Installation			Vertical Direction Installation		
	0 kg	7.5 kg	15 kg	0 kg	3.5 kg	7 kg
50 to 550	1.0	1.0	1.0	1.0	1.0	1.0
600	1.1	1.0	1.0	1.1	1.0	1.0
650	1.2	1.1	1.1	1.2	1.0	1.0
700	1.4	1.3	1.2	1.4	1.0	1.0

● Lead Screw Pitch 6 mm

◇ Horizontal Direction Installation

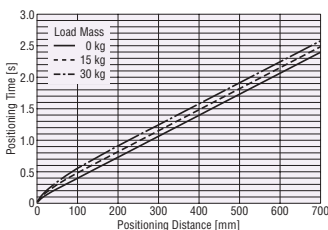

◇ Vertical Direction Installation

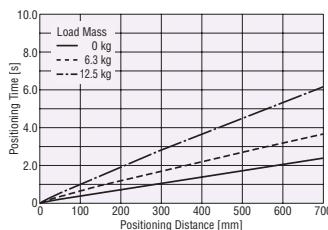

Positioning Time Coefficient

Stroke [mm]	Load Mass					
	Horizontal Direction Installation			Vertical Direction Installation		
	0 kg	15 kg	30 kg	0 kg	6.3 kg	12.5 kg
50 to 550	1.0	1.0	1.0	1.0	1.0	1.0
600	1.1	1.1	1.1	1.1	1.0	1.0
650	1.3	1.3	1.3	1.3	1.0	1.0
700	1.5	1.4	1.4	1.5	1.0	1.0

Note

- The starting speed should be 6 mm/s or less.

EZSM6: Width 74 mm × Height 66.5 mm Straight Type / Reversed Motor Type / AC Input For Cleanroom Use

Product Number

Model	Motor Orientation*1	Direction of Air Coupler for Suction*2	Lead Screw Pitch	Stroke	Equipped Motor	Motor Type	Motor Specifications
EZSM6		CR	D	005	AZ	A	C
EZSM6	L: Reversed Motor Type (Left Side) R: Reversed Motor Type (Right Side) Blank: Straight Type	CL: Left Direction CR: Right Direction	D: 12 mm E: 6 mm	005: 50 mm 010: 100 mm 015: 150 mm ~ 085: 850 mm (50 mm increment)	AZ Series	A: Single Shaft M: With Electromagnetic Brake	C: AC Input Specifications

*1 Only straight type is compatible for Cleanroom Use.

*2 For Cleanroom Use products, the direction of the air coupler for suction is required.

Electric Linear Slide Specifications

Lead Screw Pitch	mm	12	6
Electromagnetic Brake (Power off activated type)		Equipped	Not equipped
Drive Method		Ball Screw	
Repetitive Positioning Accuracy	mm	±0.02	
Minimum Travel Amount	mm	0.01	
Traveling Parallelism	mm	0.03	
Permissible Moment	Dynamic Permissible Moment	Mr:45.7 Mr:37.5 Mr:55.6	
	Static Permissible Moment	Mr:290.0 Mr:187.0 Mr:340.0	
Transportable Mass	Horizontal	30 max.	60 max.
	Vertical	15 max.	30 max.
Thrust	N	200 max.	400 [360] max.
Push Force	N	400	500
Holding Force	N	200	400 [360]
Maximum Speed by Stroke	50 to 550 mm	800	400
	600 mm	800	350
	650 mm	640	300
	700 mm	550	260
	750 mm	470	230
	800 mm	420	200
850 mm	360	180	

● The brackets [] indicate the value of the reversed motor type.

● Since the holding force is lost when the power is not supplied, the load and external force cannot be held in the vertical direction. Select a product with an electromagnetic brake for operation in the vertical direction.

Operating Speed – Load Mass

● Horizontal Direction Installation (Acceleration 3 m/s²)

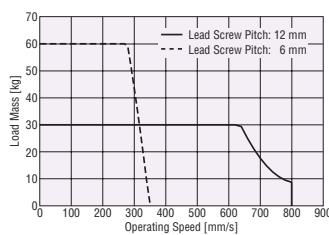

● Vertical Direction Installation (Acceleration 2 m/s²)

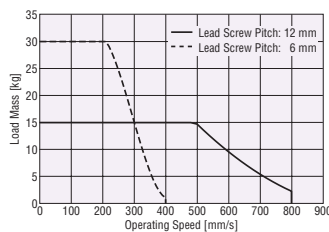

Positioning Distance – Positioning Time

The positioning time (reference) can be checked from the positioning distance.

A reference value for the positioning time can be calculated by multiplying the positioning time calculated from the graph with the positioning time coefficient for the applicable stroke.

● Lead Screw Pitch 12 mm

◇ Horizontal Direction Installation

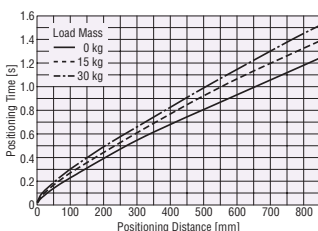

◇ Vertical Direction Installation

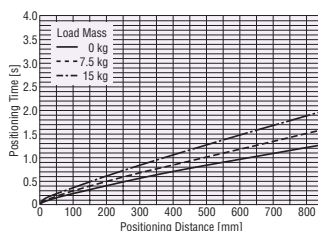

Positioning Time Coefficient

Stroke [mm]	Load Mass					
	Horizontal Direction Installation			Vertical Direction Installation		
	0 kg	15 kg	30 kg	0 kg	7.5 kg	15 kg
50 to 600	1.0	1.0	1.0	1.0	1.0	1.0
650	1.1	1.0	1.0	1.1	1.0	1.0
700	1.3	1.1	1.0	1.2	1.1	1.0
750	1.5	1.3	1.2	1.4	1.2	1.0
800	1.6	1.5	1.4	1.6	1.3	1.1
850	1.9	1.7	1.6	1.9	1.5	1.2

● Lead Screw Pitch 6 mm

◇ Horizontal Direction Installation

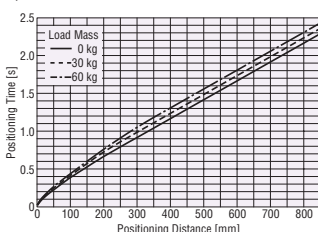

◇ Vertical Direction Installation

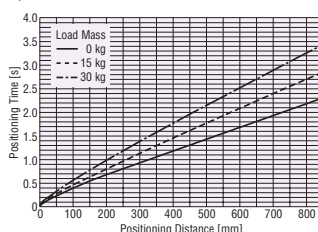

Positioning Time Coefficient

Stroke [mm]	Load Mass					
	Horizontal Direction Installation			Vertical Direction Installation		
	0 kg	30 kg	60 kg	0 kg	15 kg	30 kg
50 to 550	1.0	1.0	1.0	1.0	1.0	1.0
600	1.1	1.1	1.1	1.1	1.0	1.0
650	1.2	1.2	1.2	1.2	1.0	1.0
700	1.4	1.4	1.3	1.4	1.2	1.0
750	1.6	1.6	1.5	1.6	1.3	1.1
800	1.9	1.8	1.7	1.8	1.5	1.3
850	2.1	2.0	2.0	2.1	1.7	1.4

Note

● The starting speed should be 6 mm/s or less.

Dimensions Electric Linear Slides → Page 43, 44

EZSM6: Width 74 mm × Height 66.5 mm Straight Type / Reversed Motor Type / For Cleanroom Use DC Input

Electric Linear Slides
 QSTEP AZ Series Equipped EZS
 QSTEP AZ Series Equipped EAS
 Electric Cylinders
 QSTEP AZ Series Equipped EAC
 Driver/ Connection cable
 Peripheral Equipment

Product Number

Model	Motor Orientation*1	Direction of Air Coupler for Suction*2	Lead Screw Pitch	Stroke	Equipped Motor	Motor Type	Motor Specifications
EZSM6		CR	D	005	AZ	A	K
EZSM6	L: Reversed Motor Type (Left Side) R: Reversed Motor Type (Right Side) Blank: Straight Type	CL: Left Direction CR: Right Direction	D: 12 mm E: 6 mm	005: 50 mm 010: 100 mm 015: 150 mm 085: 850 mm (50 mm increment)	AZ Series	A: Single Shaft M: With Electromagnetic Brake	K: DC Input Specifications

- *1 Only straight type is compatible for Cleanroom Use.
- *2 For Cleanroom Use products, the direction of the air coupler for suction is required.

Electric Linear Slide Specifications

Lead Screw Pitch	mm	12	6
Electromagnetic Brake (Power off activated type)		Equipped	Not equipped
Drive Method		Ball Screw	
Repetitive Positioning Accuracy	mm	±0.02	
Minimum Travel Amount	mm	0.01	
Traveling Parallelism	mm	0.03	
Permissible Moment	Dynamic Permissible Moment	Mr:45.7 Mr:37.5 Mr:55.6	
	Static Permissible Moment	Mr:290.0 Mr:187.0 Mr:340.0	
Transportable Mass	Horizontal	30	60 max.
	Vertical	15 max.	30 max.
Thrust	N	200 max.	400 [360] max.
Push Force	N	400	500
Holding Force	N	200	400 [360]
Maximum Speed by Stroke	50 to 650 mm	600	300
	700 mm	550	260
	750 mm	470	230
	800 mm	420	200
	850 mm	360	180

- The brackets [] indicate the specifications for the reversed motor type.
- For the specifications and characteristics of 48 VDC input, please contact the nearest Oriental Motor sales office.
- Since the holding force is lost when the power is not supplied, the load and external force cannot be held in the vertical direction. Select a product with an electromagnetic brake for operation in the vertical direction.
- The maximum speed may be lower depending on the ambient temperature and the length of the motor cable.

Positioning Distance – Positioning Time

The positioning time (reference) can be checked from the positioning distance. A reference value for the positioning time can be calculated by multiplying the positioning time calculated from the graph with the positioning time coefficient for the applicable stroke.

● Lead Screw Pitch 12 mm

◇ Horizontal Direction Installation

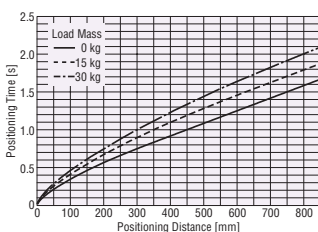

◇ Vertical Direction Installation

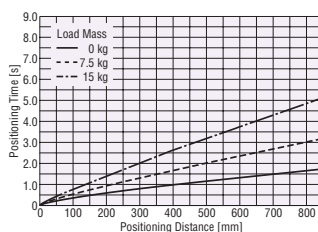

Positioning Time Coefficient

Stroke [mm]	Load Mass					
	Horizontal Direction Installation			Vertical Direction Installation		
	0 kg	15 kg	30 kg	0 kg	7.5 kg	15 kg
50 to 650	1.0	1.0	1.0	1.0	1.0	1.0
700	1.0	1.0	1.0	1.0	1.0	1.0
750	1.2	1.1	1.0	1.1	1.0	1.0
800	1.3	1.2	1.1	1.2	1.0	1.0
850	1.5	1.3	1.2	1.4	1.0	1.0

● Lead Screw Pitch 6 mm

◇ Horizontal Direction Installation

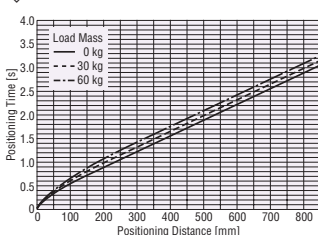

◇ Vertical Direction Installation

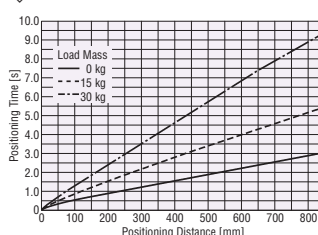

Positioning Time Coefficient

Stroke [mm]	Load Mass					
	Horizontal Direction Installation			Vertical Direction Installation		
	0 kg	30 kg	60 kg	0 kg	15 kg	30 kg
50 to 650	1.0	1.0	1.0	1.0	1.0	1.0
700	1.1	1.1	1.1	1.1	1.0	1.0
750	1.2	1.2	1.2	1.2	1.0	1.0
800	1.4	1.4	1.3	1.4	1.0	1.0
850	1.6	1.5	1.5	1.6	1.0	1.0

Note

- The starting speed should be 6 mm/s or less.

Dimensions Electric Linear Slides → Page 43, 44

Electromagnetic Brake Specification

Product Name	EZSM3, EZSM4	EZSM6
Brake Type	Power Off Activated Type	
Power Supply Voltage	24 VDC ±5%*	
Power Supply Current	0.08	0.25
Time Rating	Continuous	

*For the type with an electromagnetic brake, a 24 VDC ±4% specification applies if the wiring distance between the motor and driver is extended to 20 m using a cable.

General Specifications

		AC Input	DC Input
Thermal Class		130 (B) [UL/CSA: 105 (A)]	
Insulation Resistance		100 MΩ or more when a 500 VDC megger is applied between the following places: · Case – Motor Windings · Case – Electromagnetic Brake Windings*1	
Dielectric Strength		Sufficient to withstand the following for 1 minute: · Case – Motor Windings 1.5 kVAC, 50 Hz or 60 Hz · Case – Electromagnetic Brake Windings*1 1.5 kVAC, 50 Hz or 60 Hz	Sufficient to withstand the following for 1 minute: · Case – Motor Windings 1.0 kVAC, 50 Hz or 60 Hz · Case – Electromagnetic Brake Windings*1 1.0 kVAC, 50 Hz or 60 Hz
Operating Environment (In operation)	Ambient Temperature	0 to +40°C (Non-freezing)*3	
	Ambient Humidity	85% or less (Non-condensing)	
Atmosphere		No corrosive gases or dust. The product should not be exposed to water, oil or other liquids.	
Degree of Protection*2		IP66 (excluding installation surfaces and connector locations)	
Multiple Rotation Detection Range in Power OFF State		±900 Rotation (1800 Rotations)	

*1 Only for products with an electromagnetic brake.

*2 Only for motor parts. The degree of protection of the electric linear slide is IP20.

*3 It is based on Oriental Motor's measurement conditions.

Note

● Disconnect the motor and driver when taking an insulation resistance measurement or performing a dielectric voltage withstand test. Also, do not perform these tests on the absolute sensor part of the motor.

Travel Direction

At the time of shipment, the travel direction of the table is set as follows.

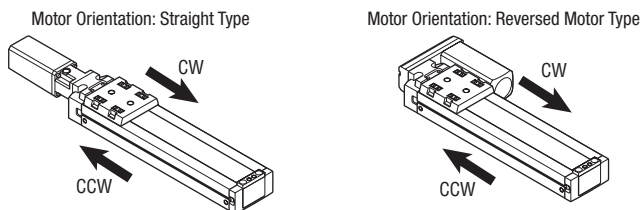

Installation of the Actuator

Note the installation location as the absolute sensor is easily affected by magnetism.

● When installing the actuator in an environment where a magnetic field is generated

Make sure that the magnetic flux density on the surface of the absolute sensor does not exceed 10 mT.

Dimensions (Unit: mm)

● EZSM3 Straight Type / For Cleanroom Use

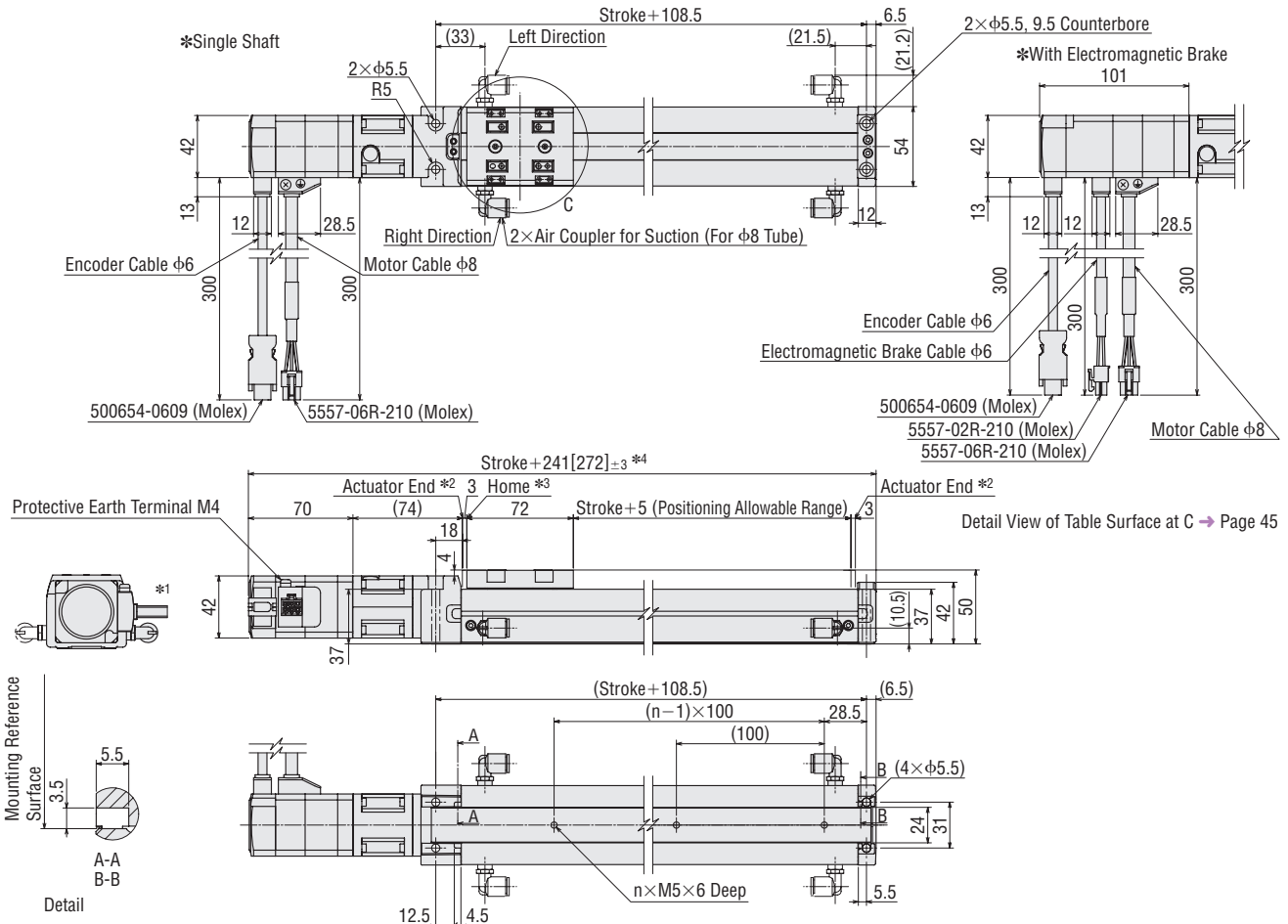

- *1 The motor cable outlet direction can be changed in 90° intervals in four directions.
- *2 During the pushing return-to-home operation, the table moves to actuator end.
- *3 When using an accessory sensor, the home position differs.
- *4 The brackets [] indicate the values for the electromagnetic brake product.
- The figure above is for Cleanroom Use. Straight type is not equipped with air couplers for suction.

Stroke [mm]	50	100	150	200	250	300	350	400	450	500	550	600	650	700
Hole Coefficient (n)	2	2	3	3	4	4	5	5	6	6	7	7	8	8
Single Shaft	1.6	1.7	1.9	2.0	2.2	2.3	2.5	2.6	2.8	2.9	3.1	3.2	3.4	3.5
Mass [kg]														
With Electromagnetic Brake	1.7	1.9	2.0	2.2	2.3	2.5	2.6	2.8	2.9	3.1	3.2	3.4	3.5	3.7

● Dimensions for linear slide installation → Page 46

Electric Linear Slides

QSTEP AZ Series Equipped EZS

QSTEP AZ Series Equipped EAS

Electric Cylinders

QSTEP AZ Series Equipped EAC

Driver/ Connection cable

Peripheral Equipment

● **EZSM3** Reversed Motor Type (Left Side)

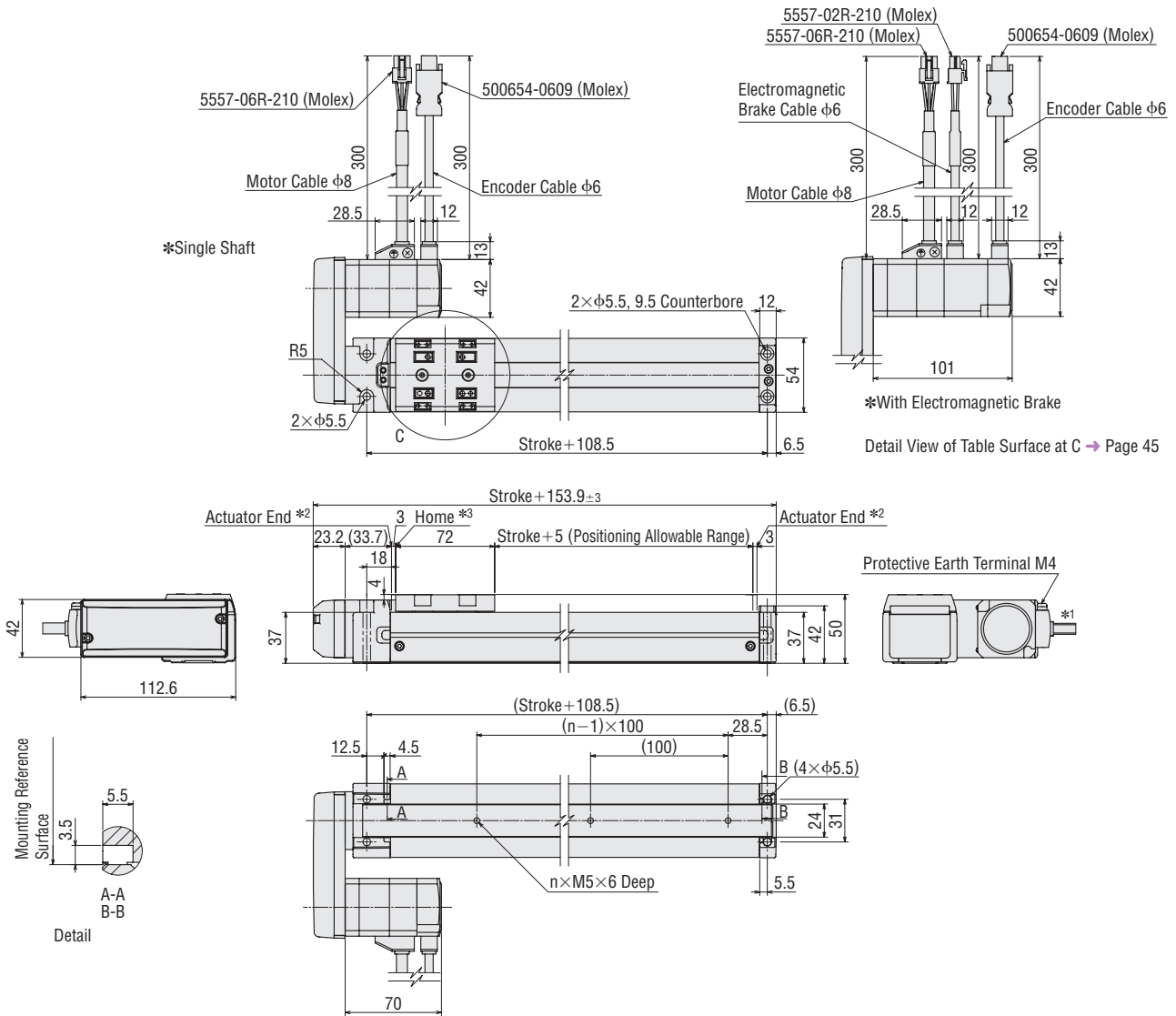

- *1 The motor cable outlet direction can be changed in 90° intervals in three directions.
- *2 During the pushing return-to-home operation, the table moves to actuator end.
- *3 When using an accessory sensor, the home position differs.
- The figure above is for the left reversed motor type. For the right reversed motor type, the motor is located on the opposite side with the slide part center.

Stroke [mm]	50	100	150	200	250	300	350	400	450	500	550	600	650	700
Hole Coefficient (n)	2	2	3	3	4	4	5	5	6	6	7	7	8	8
Mass [kg]														
Single Shaft	1.6	1.7	1.9	2.0	2.2	2.3	2.5	2.6	2.8	2.9	3.1	3.2	3.4	3.5
With Electromagnetic Brake	1.7	1.9	2.0	2.2	2.3	2.5	2.6	2.8	2.9	3.1	3.2	3.4	3.5	3.7

● Dimensions for linear slide installation → Page 46

● **EZSM4** Straight Type / For Cleanroom Use

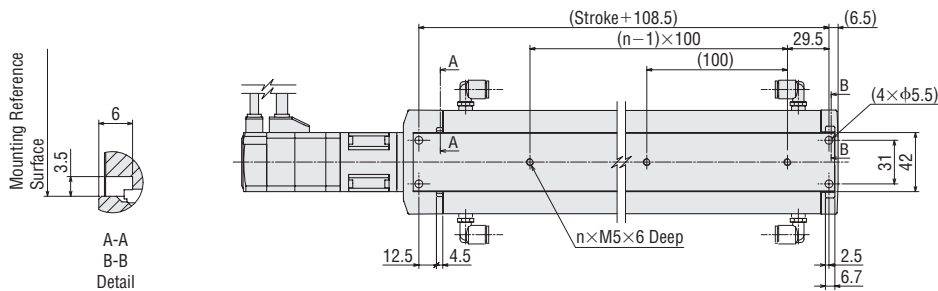
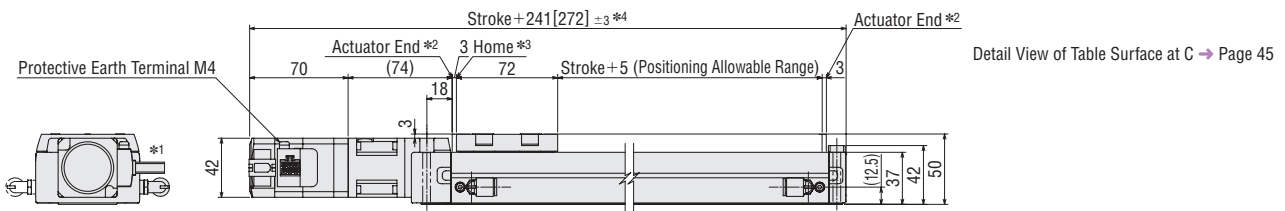
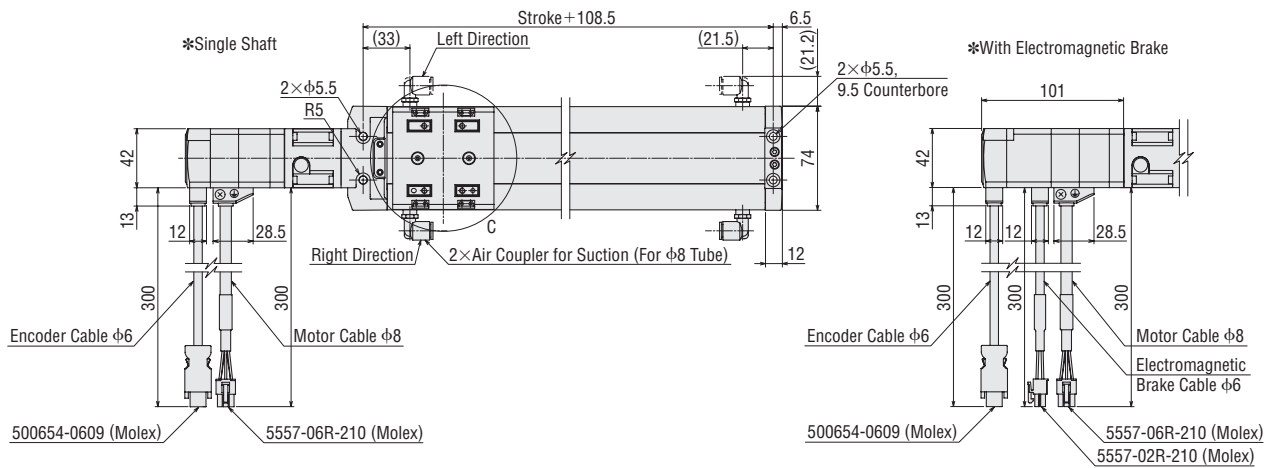

- *1 The motor cable outlet direction can be changed in 90° intervals in four directions.
- *2 During the pushing return-to-home operation, the table moves to actuator end.
- *3 When using an accessory sensor, the home position differs.
- *4 The brackets [] indicate the values for the electromagnetic brake product.
- The figure above is for Cleanroom Use. Straight type is not equipped with air couplers for suction.

Stroke [mm]	50	100	150	200	250	300	350	400	450	500	550	600	650	700		
Hole Coefficient (n)	2	2	3	3	4	4	5	5	6	6	7	7	8	8		
Mass [kg]	Single Shaft		2.0	2.2	2.5	2.7	2.9	3.2	3.4	3.6	3.8	4.1	4.3	4.5	4.7	5.0
	With Electromagnetic Brake		2.2	2.4	2.6	2.9	3.1	3.3	3.5	3.8	4.0	4.2	4.5	4.7	4.9	5.1

● Dimensions for linear slide installation → Page 46

Electric Linear Slides

Q-STEP AZ Series Equipped EZS

Q-STEP AZ Series Equipped EAS

Electric Cylinders

Q-STEP AZ Series Equipped EAC

Driver/Connection cable

Peripheral Equipment

● **EZSM4** Reversed Motor Type (Left Side)

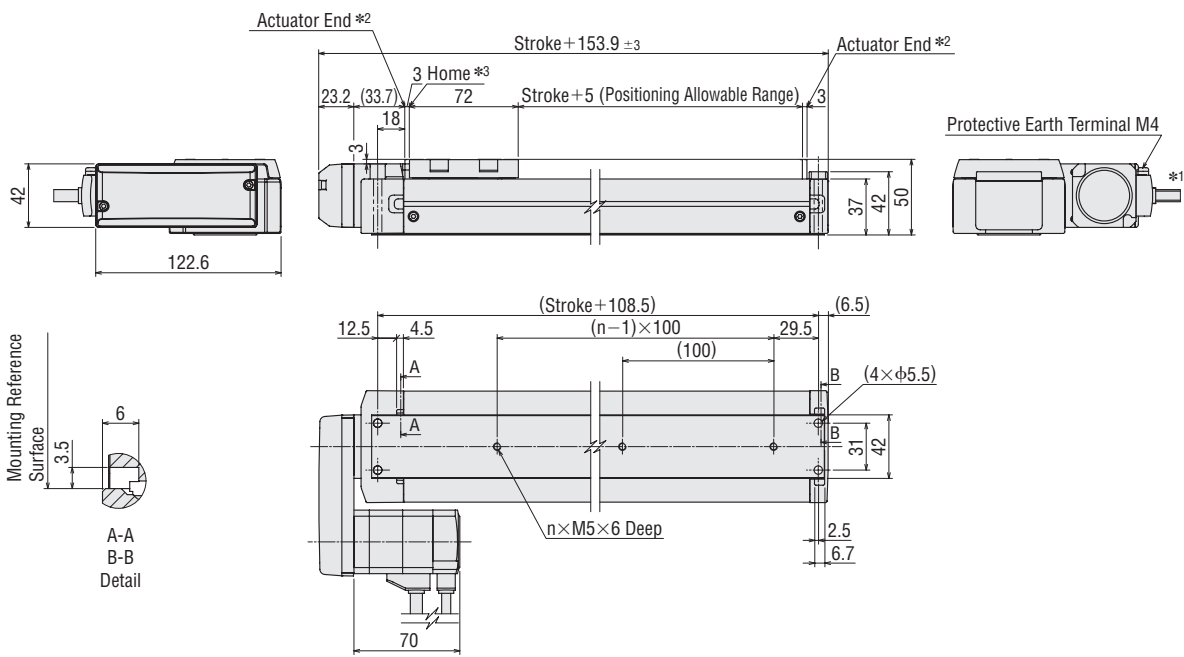
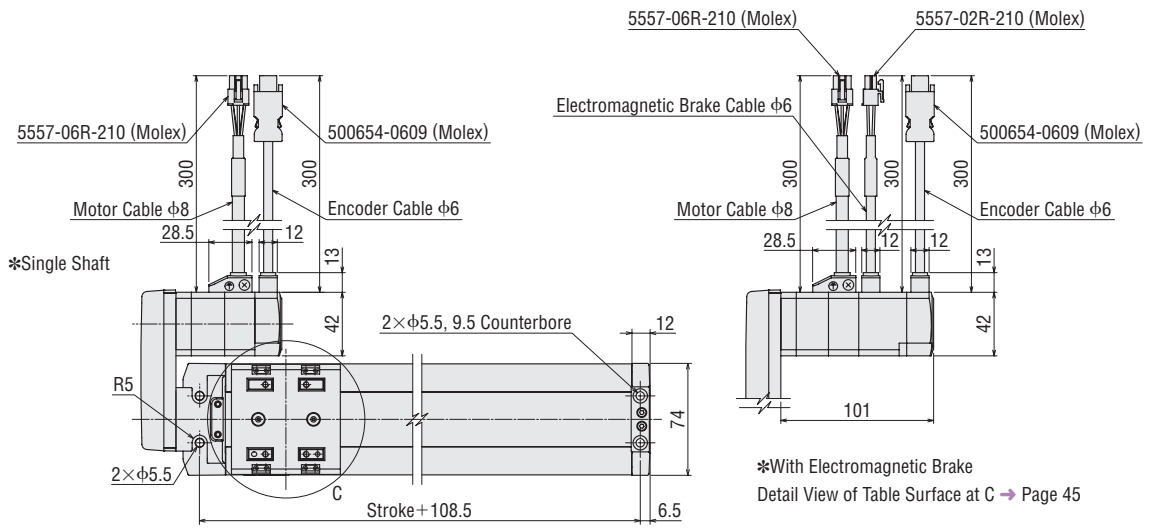

*1 The motor cable outlet direction can be changed in 90° intervals in three directions.

*2 During the pushing return-to-home operation, the table moves to actuator end.

*3 When using an accessory sensor, the home position differs.

● The figure above is for the left reversed motor type. For the right reversed motor type, the motor is located on the opposite side with the slider part center.

Stroke [mm]	50	100	150	200	250	300	350	400	450	500	550	600	650	700
Hole Coefficient (n)	2	2	3	3	4	4	5	5	6	6	7	7	8	8
Single Shaft	2.0	2.2	2.5	2.7	2.9	3.2	3.4	3.6	3.8	4.1	4.3	4.5	4.7	5.0
With Electromagnetic Brake	2.2	2.4	2.6	2.9	3.1	3.3	3.5	3.8	4.0	4.2	4.5	4.7	4.9	5.1

● Dimensions for linear slide installation → Page 46

● **EZSM6** Straight Type / For Cleanroom Use

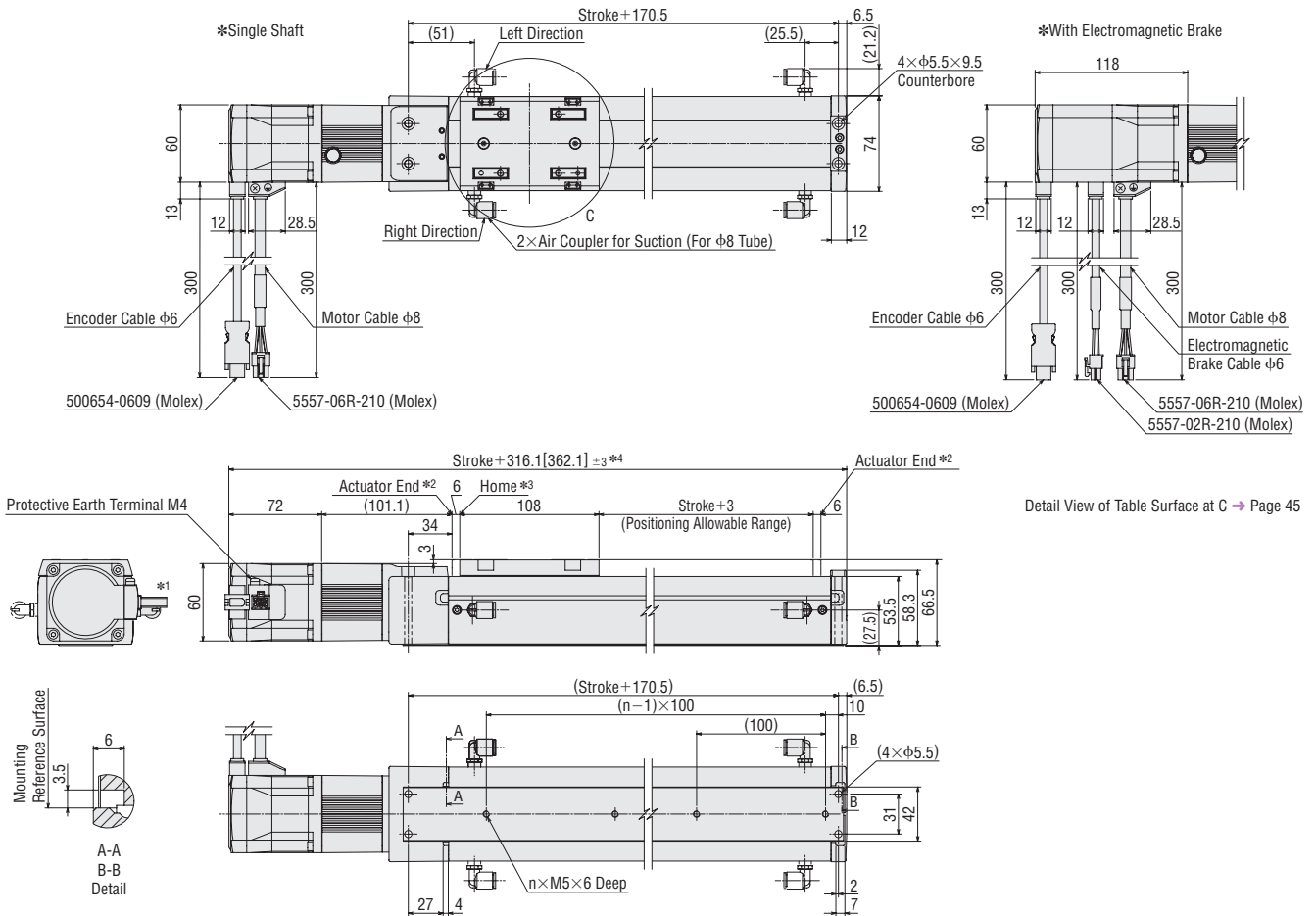

- *1 The motor cable outlet direction can be changed in 90° intervals in four directions.
 - *2 During the pushing return-to-home operation, the table moves to actuator end.
 - *3 When using an accessory sensor, the home position differs.
 - *4 The brackets [] indicate the values for the electromagnetic brake product.
- The figure above is for Cleanroom Use. Straight type is not equipped with air couplers for suction.

Stroke [mm]	50	100	150	200	250	300	350	400	450	500	550	600	650	700	750	800	850		
Hole Coefficient (n)	3	3	4	4	5	5	6	6	7	7	8	8	9	9	10	10	11		
Mass [kg]	Single Shaft		3.8	4.1	4.3	4.6	4.8	5.1	5.3	5.6	5.9	6.1	6.4	6.6	6.9	7.1	7.4	7.6	7.9
	With Electromagnetic Brake		4.2	4.4	4.7	5.0	5.2	5.5	5.7	6.0	6.2	6.5	6.8	7.0	7.3	7.5	7.8	8.0	8.3

● Dimensions for linear slide installation → Page 46

Electric Linear Slides

QSTEP AZ Series Equipped EZS

QSTEP AZ Series Equipped EAS

Electric Cylinders

QSTEP AZ Series Equipped EAC

Driver/ Connection cable

Peripheral Equipment

● **EZSM6 Reversed Motor Type (Left Side)**

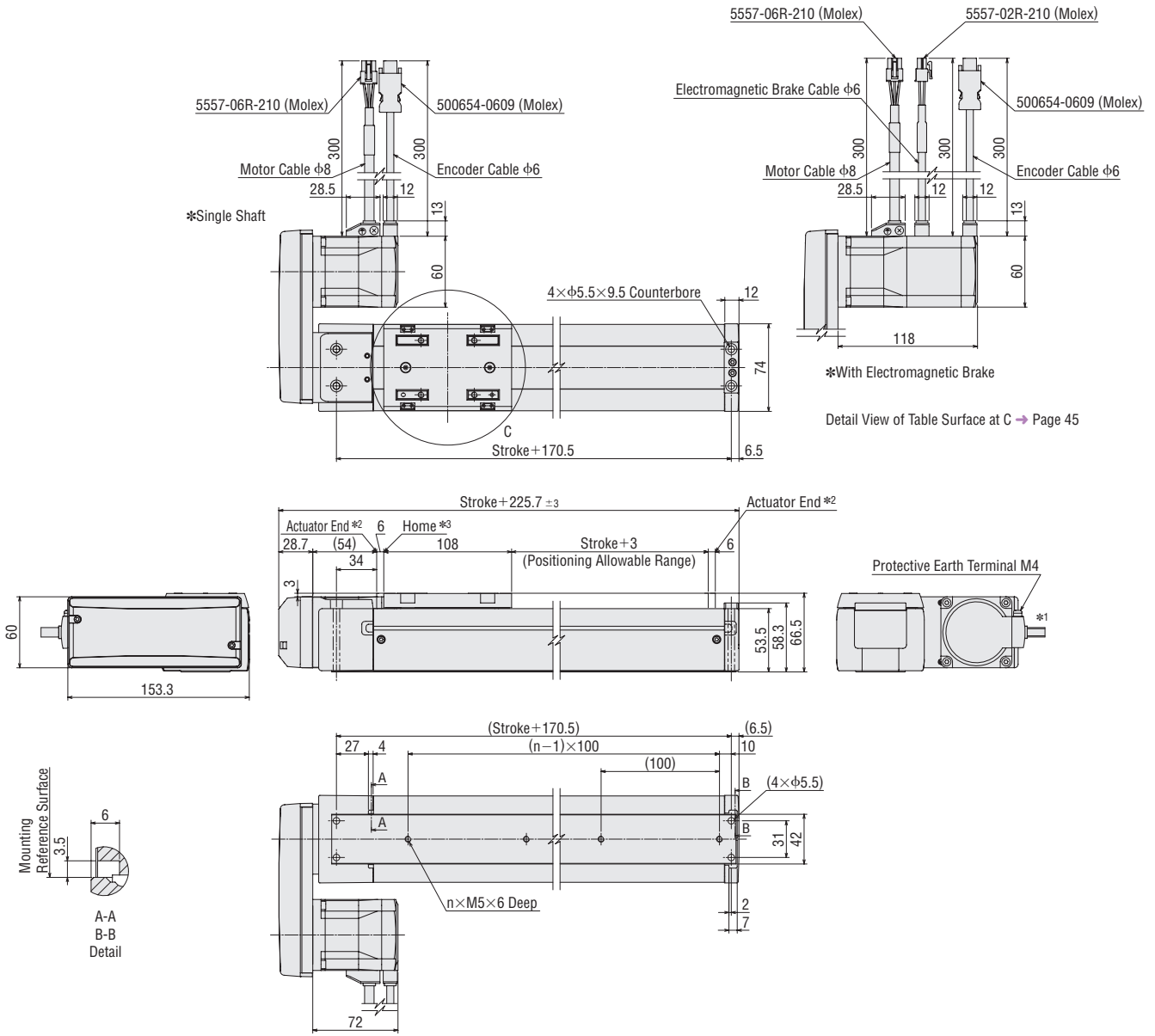

- *1 The motor cable outlet direction can be changed in 90° intervals in three directions.
- *2 During the pushing return-to-home operation, the table moves to actuator end.
- *3 When using an accessory sensor, the home position differs.
- The figure above is for the left reversed motor type. For the right reversed motor type, the motor is located on the opposite side with the slider part center.

Stroke [mm]	50	100	150	200	250	300	350	400	450	500	550	600	650	700	750	800	850		
Hole Coefficient (n)	3	3	4	4	5	5	6	6	7	7	8	8	9	9	10	10	11		
Mass [kg]	Single Shaft		3.8	4.1	4.3	4.6	4.8	5.1	5.3	5.6	5.9	6.1	6.4	6.6	6.9	7.1	7.4	7.6	7.9
	With Electromagnetic Brake		4.2	4.4	4.7	5.0	5.2	5.5	5.7	6.0	6.2	6.5	6.8	7.0	7.3	7.5	7.8	8.0	8.3

● Dimensions for linear slide installation → Page 46

● Detail View of Table Surface at C (Unit: mm)

● EZSM3

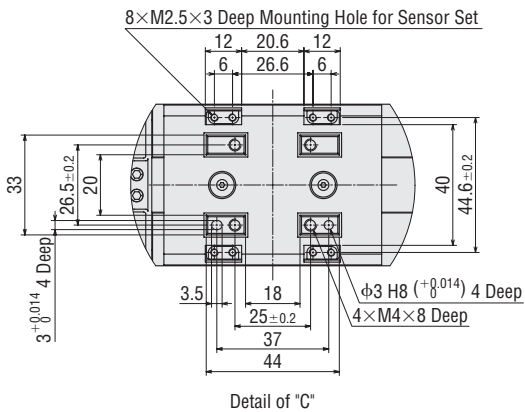

● EZSM4

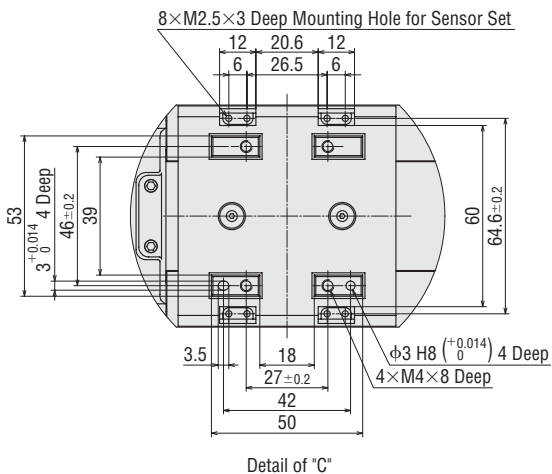

● EZSM6

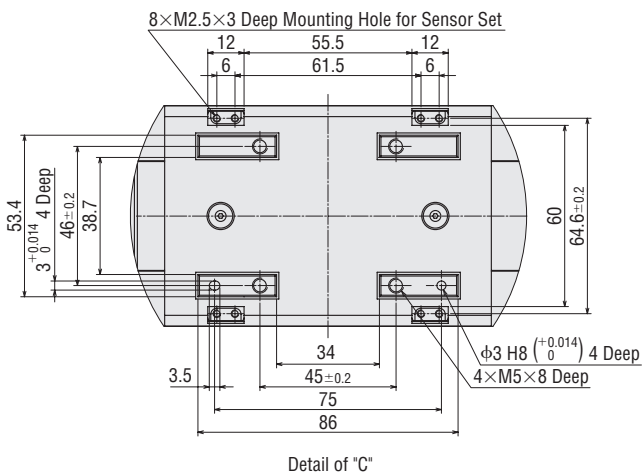

Electric
Linear
Slides

QSTEP
AZ Series
Equipped
EZS

QSTEP
AZ Series
Equipped
EAS

Electric
Cylinders

QSTEP
AZ Series
Equipped
EAC

Driver/
Connection
cable

Peripheral
Equipment

● Dimensions for linear slide installation (Unit: mm)

● EZSM3

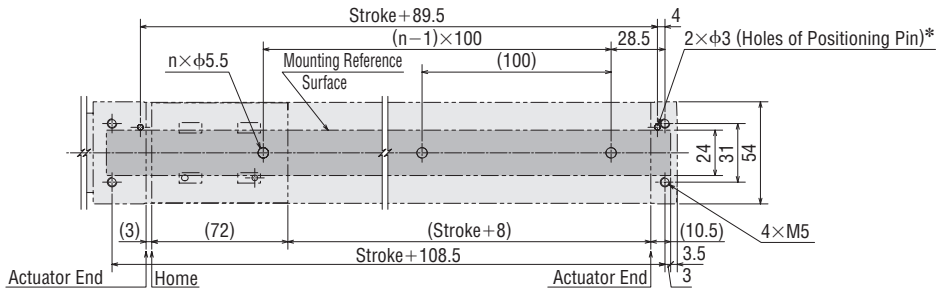

* The mounting reference surface can be set on either side. The above figure assumes that the linear slide is installed on its top surface.

● EZSM4

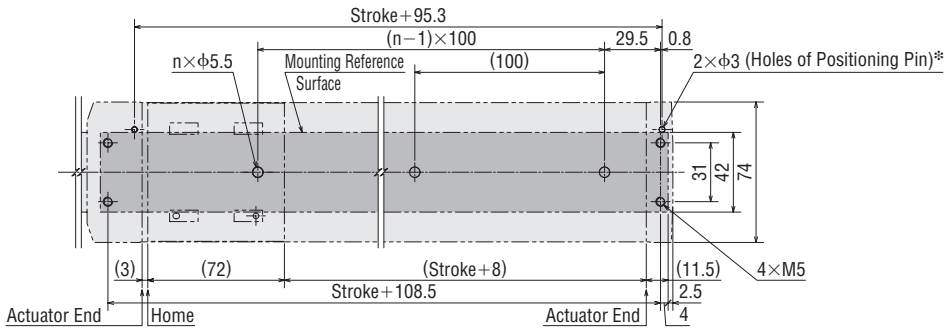

* The mounting reference surface can be set on either side. The above figure assumes that the linear slide is installed on its top surface.

● EZSM6

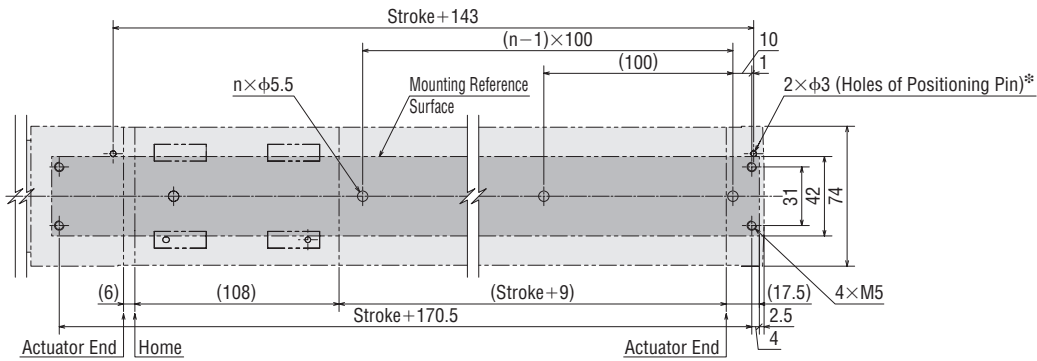

* The mounting reference surface can be set on either side. The above figure assumes that the linear slide is installed on its top surface.

Particulate-Generation Amount of Cleanroom Use

The **EZS** Series has achieved ISO Standard Class 3 (equivalent to FED Standard Class 1) with improved airtightness through the use of low particulate-generative grease and a stainless steel sheet.

Measurement Method

The method for measuring the level of cleanliness is shown below. (Conforms to Japanese Industrial Standards (JIS) B 9926)

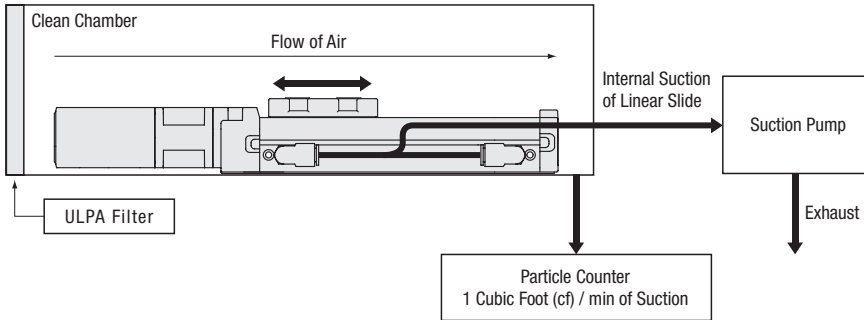

ISO Standards Class 3

Particle Diameter (μm)	Amount of Particle Generation [Pieces/ m^3]
0.1	1000 or less
0.3	102 or less
0.5	35 or less

Correlation Diagram of Particulate-Generation and Suction Volume (Actual values measured from the sample data)

EZSM3CLD050, EZSM3CRD050

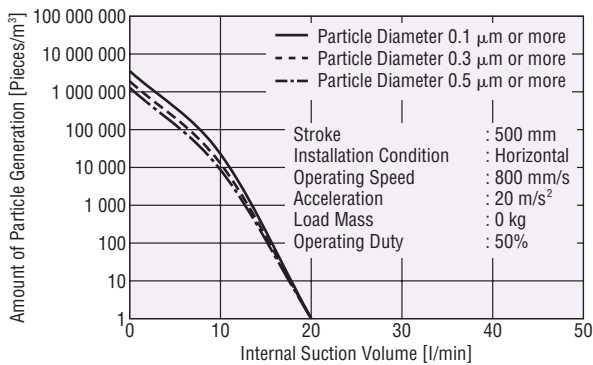

EZSM4CLD050, EZSM4CRD050

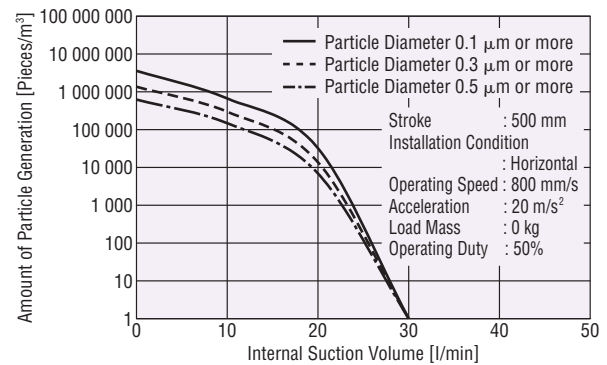

EZSM6CLD050, EZSM6CRD050

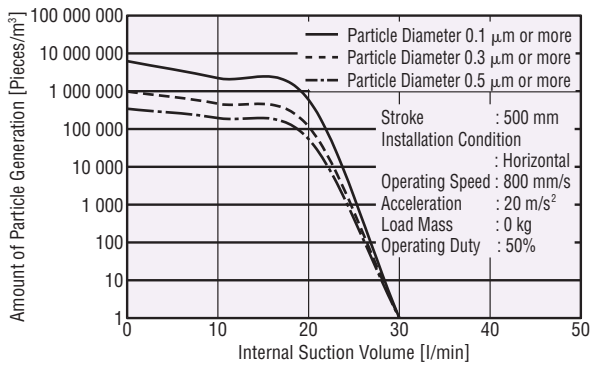

● The product names on the characteristics diagram are listed such that the product names can be determined.

About Use of the EZSM6 (AC Input Type) for Vertical Driving

When operating **EZSM6*** type electric linear slides in the vertical direction, depending on the driving conditions, an overvoltage protection alarm may be detected. In such case, refer to the operating speed-load mass characteristics diagram, and connect the Oriental Motor's **RGB100** regeneration resistor to the driver.

*Common to all AC input specifications of **D** (lead screw pitch 12 mm) / **E** (lead screw pitch 6 mm), Straight / Reversed motor / For cleanroom use.

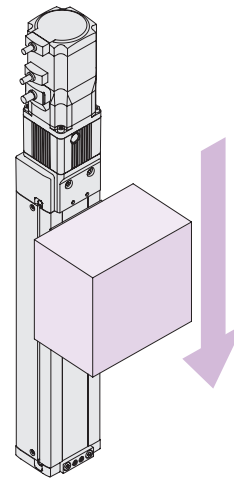

Example of Vertical Use

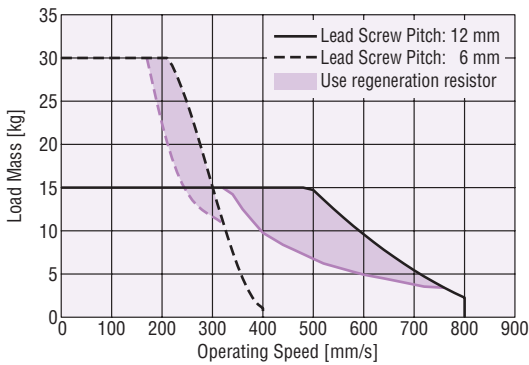

Region in which the regeneration resistor is required for **EZSM6** (AC Input Type)

● Regeneration Resistor

When a regeneration resistor is connected to the special terminal on the driver, the regenerative power that is fed back from the motor is released as heat energy.



◇ Product Line

Product Name	Applicable Product	List Price
RGB100	AC Input Driver	45.00 €

◇ Specifications

Item	Specifications
Continuous Regenerative Power	50 W
Resistance Value	150 Ω
Thermostat Operating Temperature	Open: 150±7°C Close: 145±12°C (Normally Closed)
Thermostat Electrical Rating	120 VAC 4 A 30 VDC 4 A (Minimum current 5 mA)

● Install the regeneration resistor in the place which has the same heat radiation capability as heat radiation plate [Material: Aluminum 350 mm×350 mm, 3 mm thick].

Electric
Linear
Slides

QSTEP
AZ Series
Equipped
EZS

QSTEP
AZ Series
Equipped
EAS

Electric
Cylinders

QSTEP
AZ Series
Equipped
EAC

Driver/
Connection
cable

Peripheral
Equipment

Electric Linear Slides

EAS Series α STEP AZ Series Equipped

Please refer to the Oriental Motor website for technical reference and regulations & standards about this product.

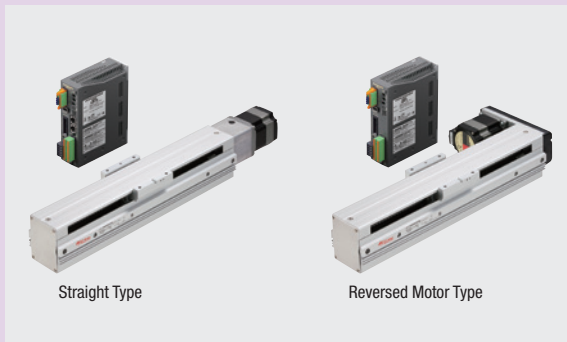

The motor component incorporates a high-efficiency, energy-saving α STEP AZ Series electric linear slide. In addition to straight-type actuators, reversed motor types with shorter overall length that can contribute to space saving are also available.

- High performance regardless of operating conditions
- Compactness and high strength for a wide variety of applications
- Easy belt replacement (reversed motor type)

Features

Wide Variety of Products Broadens Equipment Design and Performance

The product line for compact, high accuracy, and high rigidity slides also includes reversed motor types with shorter overall length. Standard motors from the AZ Series are equipped. Various products are available.

Motor

α STEP AZ Series

- Built-in battery-free absolute sensor
- Positioning information is available without a sensor
- High reliability with closed loop control
- High efficiency technology reduces motor heat generation and saves energy



Built-in Controller Type



Pulse Input Type



Network Compatible

EtherNet/IP
EtherCAT
PROFINET

Electric Linear Slides



Straight Type X-Table



Straight Type Y-Table



Reversed Motor Type X-Table
● This photo shows the right side type



Reversed Motor Type Y-Table
● This photo shows the right side type

● This photo shows the **EASM6** (width 75.4 mm × height 83 mm).

FLEX What is FLEX?

FLEX is the collective name for products that support I/O control, Modbus (RTU) control, and FA network control via network converters.

These products enable simple connection and simple control, shortening the total lead time for system construction.

High Performance Regardless of Operating Conditions

A wide range of applications, from low speed to high speed and from light loads to heavy loads. These high-performance electric linear slides are now even easier to use.

● Agile Responsiveness

By utilizing the high responsiveness of the stepper motor, quick short distance positioning is possible.

Stepper motors operate synchronously with pulse commands and generate high torque with a compact body, and offer excellent acceleration performance and response.

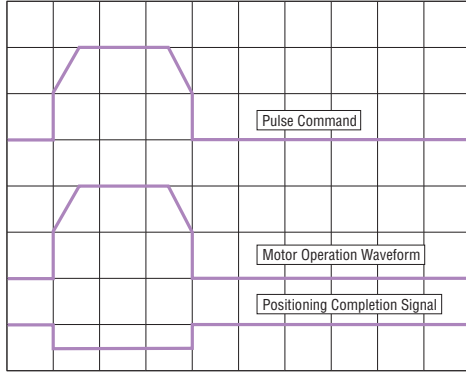

<Product Used>
Product Name: **EASM4**
Lead: 12 mm
Input Type: 200 VAC

<Example Operation>
Horizontal Load Mass: No load
Inching Drive: 60 mm (3 outward),
180 mm (1 return)
Operating Speed: 800 mm/s
Acceleration: 20 m/s² (2 G)

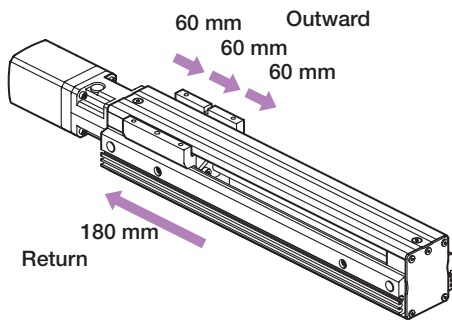

Movement of Electric Linear Slide Table Compared to Operation Commands

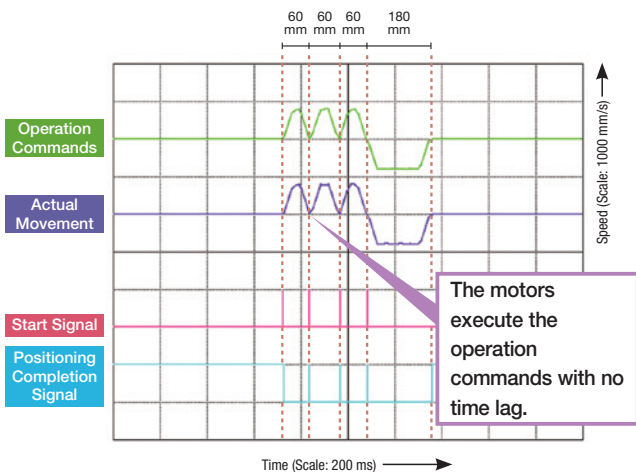

This contributes to reduced equipment takt time.

● Stability at Low Speeds

Thanks to the microstep drive system and smooth drive function*, which come standard, resolution can be improved without mechanical elements such as a speed reduction mechanism. As a result, speed fluctuation is minimal even at low speeds, leading to improved stability.

*The smooth drive function automatically implements microstep drive based on the same traveling amount and traveling speed used in the full step mode, without changing the pulse input settings.

<Product Used>
Product Name: **EASM4**
Lead: 12 mm
Input Type: 200 VAC

<Example Operation>
Horizontal Load Mass: 0.5 kg
Running Current: 100%
Resolution: 0.01 mm/step
Operating Speed: 1.25 mm/s

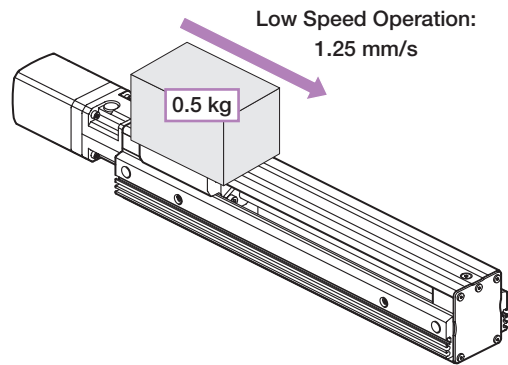

Actual Speed of Electric Linear Slide Table Compared to Operation Commands (1.25 mm/s)

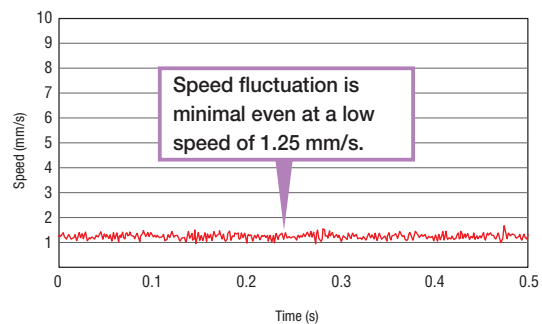

Minimal speed fluctuation and suppressed vibration, even at low speeds.

Electric Linear Slides

QSTEP AZ Series Equipped EZS

QSTEP AZ Series Equipped EAS

Electric Cylinders

QSTEP AZ Series Equipped EAC

Driver/Connection cable

Peripheral Equipment

● High Speed Driving with Light Load or Heavy Load

High speed driving with a light load or heavy load can be achieved, even with inching operation.

<Product Used>
 Product Name: **EASM6**
 Lead: 6 mm
 Input Type: 200 VAC

<Example Operation>
 Load Mass: 15 kg
 Positioning Distance: 500 mm
 Drive Direction: Vertical

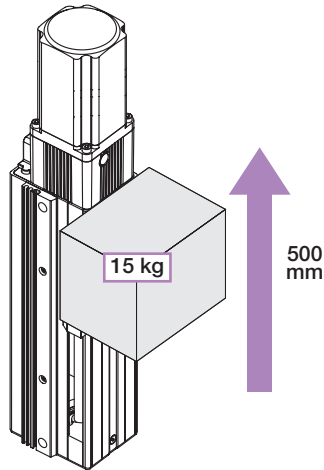

High Speed Driving Even with a Heavy Load

High speed driving is possible, even if a heavy load is being transported vertically.

Load Mass: 15 kg
 Positioning Distance: 500 mm
 Positioning Time: 1.77 s
 Operating Speed: 320 mm/s
 Acceleration: 1.5 m/s² (0.15 G)

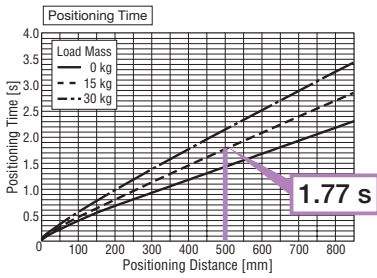

High Speed Driving Even with a Light Load

High speed driving is still possible, even with no load on the return trip.

Load Mass: 0 kg
 Positioning Distance: 500 mm
 Positioning Time: 1.4 s
 Operating Speed: 400 mm/s
 Acceleration: 2 m/s² (0.2 G)

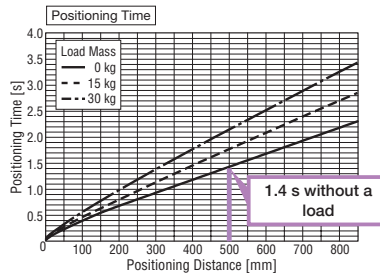

High Speed Driving Even in Inching Operation

High speed driving is still possible, even in inching operation with minute distances.

Load Mass: 15 kg
 Positioning Distance: 20 mm
 Positioning Time: 0.14 s
 Operating Speed: 200 mm/s
 Acceleration: 4.7 m/s² (0.5 G)

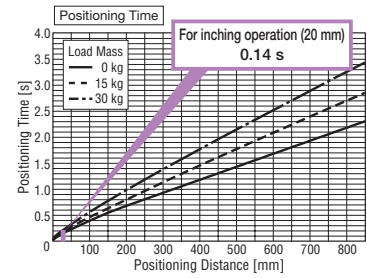

Compactness and High Strength for a Wide Variety of Applications

● Compact, High Accuracy, High Rigidity Slides

This is an electric linear slide with a ball screw and an LM guide with ball retainer manufactured by THK*. This slide is suitable for applications where traveling parallelism is required because the highly accurate LM guide is directly installed to customer's enclosure base. (Traveling parallelism of 0.03 mm or less) Although this slider is compact, it is rigid and can transport large masses.

*"Ball retainer" and "LM guide" are registered trademarks of THK Co., Ltd.

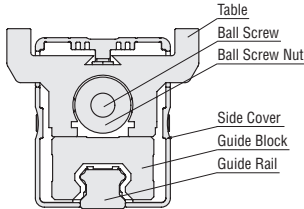

For **EASM6**

◇ Transportable Mass of **EASM6** Type

- Max. Horizontal Transportable Mass: 60 kg
- Max. Vertical Transportable Mass: 30 kg

◇ Horizontal Installation

A press force up to 110 N is permissible, even with an overhang length of 1 m.

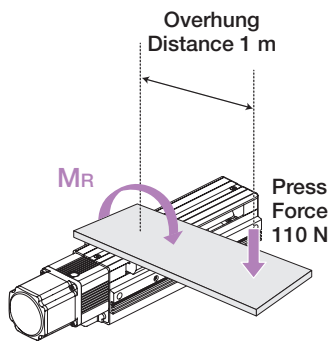

Static Permissible Moment

Load moment that the linear guide can support while the motor is stopped

◇ Vertical Installation

A load up to 10 kg can be transported, even with an overhang length of 0.24 m.

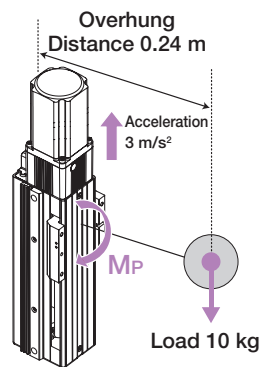

Dynamic Permissible Moment

Load moment that the linear guide can support while the motor is in operation

The press force and load were calculated using the static permissible moment 110.0 Nm and dynamic permissible moment 31.8 Nm for **EASM6**. (Plate weight was not considered.)

Dynamic Permissible Moment [N·m]	M_p : 31.8	M_v : 10.3	M_R : 40.6
Static Permissible Moment [N·m]	M_p : 86.0	M_v : 34.0	M_R : 110.0

● Motor Installation Direction

Product line of reversed type motors. The shorter overall length contributes to space saving.

The straight type and reversed type are the same price.

EASM4 With Electromagnetic Brake Stroke 200 mm

Straight Type

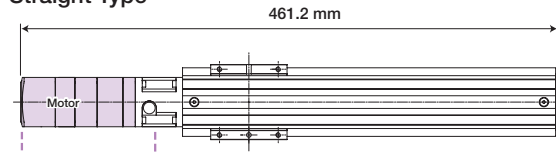

Reversed Motor Type

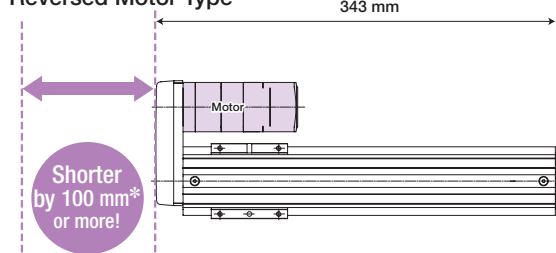

*With Electromagnetic Brake

● Cable Outlet Direction

Can be rotated in 4 possible directions (3 for reversed motor type)

The motor cable outlet direction can be freely changed.

Because the cable protrudes from the side of the motor, no space behind the motor is needed, further contributing to equipment space saving.

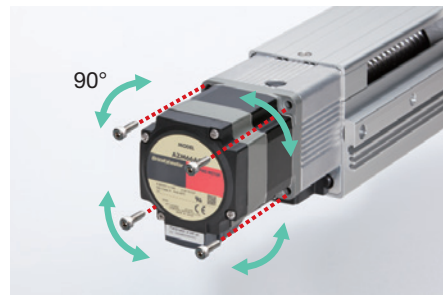

Electric Linear Slides

QSTEP AZ Series Equipped **EZS**

QSTEP AZ Series Equipped **EAS**

Electric Cylinders

QSTEP AZ Series Equipped **EAC**

Driver/ Connection cable

Peripheral Equipment

Easy Belt Replacement (Reversed Motor Type)

The belt can easily be replaced with Oriental Motor's unique belt tension adjustment mechanism.

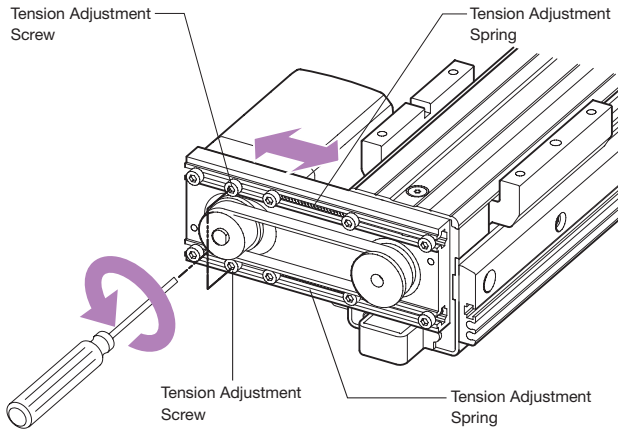

Loosen the screw to adjust the belt to the appropriate tension with spring force.

With Sensor Rails/Without Sensor Rails

With Sensor Rails

Sensors (sold separately) can be fixed to the sensor rails on the sides of the slider.

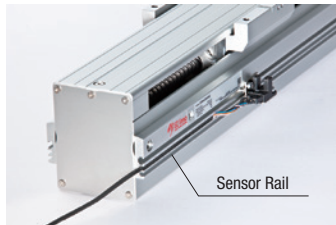

Without Sensor Rails

When sensors will not be used or when a sensor is installed somewhere other than the slider, the product without sensor rails is recommended. Space can be reduced and the design can be minimized.



●EASM4 X-Table

With Sensor Rails

Without Sensor Rails

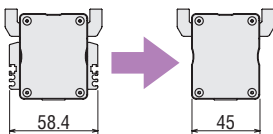

●EASM4 Y-Table



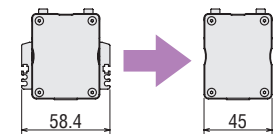

With Sensor Rails

Without Sensor Rails



The slider width is reduced by 13 mm

Product Line

Table	Straight Type	Reversed Motor Type (Right side/left side)
X-Table*1		 This photo shows the right side type
Y-Table*2		 This photo shows the right side type

● A built-in controller type and pulse input type are available, in both AC Input and DC Input types.

*1 The X-table can mitigate the intrusion of falling foreign particles when installed horizontally.

*2 The Y-table can mitigate the intrusion of falling foreign particles when wall-mounted.

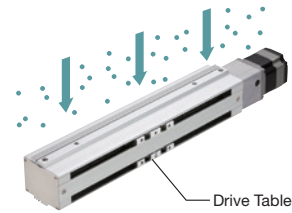
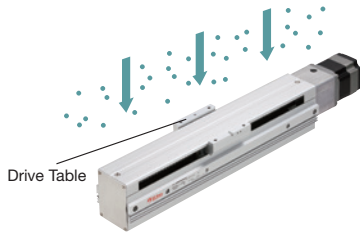

● Image of 3-axis Equipment Using **EAS** Series Electric Linear Slides on the X- and Y-axes and an **EAC** Series Electric Cylinder on the Z-axis

Y-axis Electric Linear Slides **EAS** Series
Reversed Motor Type

Save space by using reversed motors.

Z-Axis Electric Cylinders **EAC** Series
Reversed Motor Type with Shaft Guide Cover

Save space by using reversed motors, and reduce equipment startup burden by using shaft guide covers.

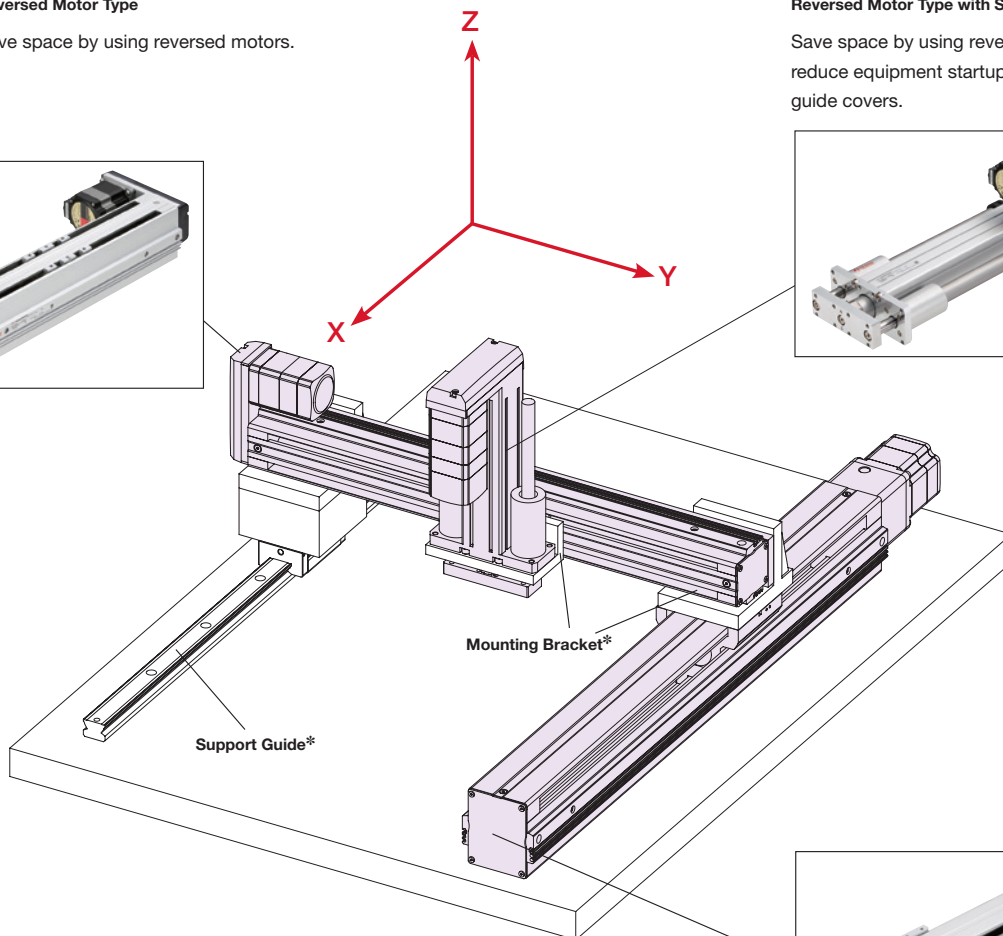
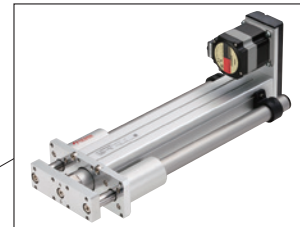

*Support guides and mounting brackets not supplied.

X-axis Electric Linear Slides **EAS** Series
Straight Type



Electric
Linear
Slides

QSTEP
AZ Series
Equipped
EAS

QSTEP
AZ Series
Equipped
EAS

Electric
Cylinders

QSTEP
AZ Series
Equipped
EAC

Driver/
Connection
cable

Peripheral
Equipment

Product Line of Electric Linear Slides

● AC Input

◇ Product Number

① Model	② Motor Orientation	③ Sensor Rail	④ Table Orientation	⑤ Lead Screw Pitch	⑥ Stroke	⑦ Equipped Motor	⑧ Motor Type	⑨ Motor Specifications
EASM4	L	N	X	D	005	AZ	A	C
EASM4 EASM6	L: Reversed Motor Type (Left Side) R: Reversed Motor Type (Right Side) Blank: Straight Type	N: Without Sensor Rail Blank: With Sensor Rail	X: X-table Y: Y-table	D: 12 mm E: 6 mm	005: 50 mm 010: 100 mm 015: 150 mm ~ 085: 850 mm (50 mm increment)	AZ Series	A: Single Shaft M: With Electromagnetic Brake	C: AC Input Specifications

◇ **EASM4** Straight Type / Reversed Motor Type

The prices are the same even if ② Motor Orientation (L, R, Blank), ③ Sensor Rail (N, Blank), ④ Table Orientation (X, Y), ⑤ Lead Screw Pitch (D, E) are different.

⑧ Motor Type (A, M)	Single Shaft (A)	With Electromagnetic Brake (M)	
⑥ Stroke	50 mm (005)	730.00 €	904.00 €
	100 mm (010)	730.00 €	904.00 €
	150 mm (015)	758.00 €	932.00 €
	200 mm (020)	758.00 €	932.00 €
	250 mm (025)	778.00 €	959.00 €
	300 mm (030)	778.00 €	959.00 €
	350 mm (035)	805.00 €	976.00 €
	400 mm (040)	805.00 €	976.00 €
	450 mm (045)	832.00 €	1,003.00 €
	500 mm (050)	832.00 €	1,003.00 €
	550 mm (055)	851.00 €	1,029.00 €
	600 mm (060)	851.00 €	1,029.00 €
	650 mm (065)	878.00 €	1,056.00 €
	700 mm (070)	878.00 €	1,056.00 €

◇ **EASM6** Straight Type / Reversed Motor Type

The prices are the same even if ② Motor Orientation (L, R, Blank), ③ Sensor Rail (N, Blank), ④ Table Orientation (X, Y), ⑤ Lead Screw Pitch (D, E) are different.

⑧ Motor Type (A, M)	Single Shaft (A)	With Electromagnetic Brake (M)	
⑥ Stroke	50 mm (005)	981.00 €	1,209.00 €
	100 mm (010)	981.00 €	1,209.00 €
	150 mm (015)	1,008.00 €	1,236.00 €
	200 mm (020)	1,008.00 €	1,236.00 €
	250 mm (025)	1,036.00 €	1,252.00 €
	300 mm (030)	1,036.00 €	1,252.00 €
	350 mm (035)	1,056.00 €	1,280.00 €
	400 mm (040)	1,056.00 €	1,280.00 €
	450 mm (045)	1,082.00 €	1,307.00 €
	500 mm (050)	1,082.00 €	1,307.00 €
	550 mm (055)	1,110.00 €	1,333.00 €
	600 mm (060)	1,110.00 €	1,333.00 €
	650 mm (065)	1,137.00 €	1,361.00 €
	700 mm (070)	1,137.00 €	1,361.00 €
	750 mm (075)	1,155.00 €	1,387.00 €
800 mm (080)	1,155.00 €	1,387.00 €	
850 mm (085)	1,182.00 €	1,402.00 €	

● DC Input

◇ Product Number

① Model	② Motor Orientation	③ Sensor Rail	④ Table Orientation	⑤ Lead Screw Pitch	⑥ Stroke	⑦ Equipped Motor	⑧ Motor Type	⑨ Motor Specifications
EASM4	L	N	X	D	005	AZ	A	K
EASM2 EASM4 EASM6	L: Reversed Motor Type (Left Side) R: Reversed Motor Type (Right Side) Blank: Straight Type	N: Without Sensor Rail Blank: With Sensor Rail	X: X-table Y: Y-table	D: 12 mm E: 6 mm F: 3 mm	005: 50 mm 010: 100 mm 015: 150 mm ~ 085: 850 mm (50 mm increment)	AZ Series	A: Single Shaft M: With Electromagnetic Brake	K: DC Input Specifications

◇ EASM2 Straight Type

The prices are the same even if ③ Sensor Rail (N, Blank), ④ Table Orientation (X, Y), ⑤ Lead Screw Pitch (E, F) are different.

⑥ Stroke	Price
50 mm (005)	651.00 €
100 mm (010)	651.00 €
150 mm (015)	676.00 €
200 mm (020)	676.00 €
250 mm (025)	700.00 €
300 mm (030)	700.00 €

◇ EASM4 Straight Type / Reversed Motor Type

The prices are the same even if ② Motor Orientation (L, R, Blank), ③ Sensor Rail (N, Blank), ④ Table Orientation (X, Y), ⑤ Lead Screw Pitch (D, E) are different.

⑧ Motor Type (A, M)	Single Shaft (A)	With Electromagnetic Brake (M)	
⑥ Stroke	50 mm (005)	730.00 €	904.00 €
	100 mm (010)	730.00 €	904.00 €
	150 mm (015)	758.00 €	932.00 €
	200 mm (020)	758.00 €	932.00 €
	250 mm (025)	778.00 €	959.00 €
	300 mm (030)	778.00 €	959.00 €
	350 mm (035)	805.00 €	976.00 €
	400 mm (040)	805.00 €	976.00 €
	450 mm (045)	832.00 €	1,003.00 €
	500 mm (050)	832.00 €	1,003.00 €
	550 mm (055)	851.00 €	1,029.00 €
	600 mm (060)	851.00 €	1,029.00 €
	650 mm (065)	878.00 €	1,056.00 €
	700 mm (070)	878.00 €	1,056.00 €

◇ EASM6 Straight Type / Reversed Motor Type

The prices are the same even if ② Motor Orientation (L, R, Blank), ③ Sensor Rail (N, Blank), ④ Table Orientation (X, Y), ⑤ Lead Screw Pitch (D, E) are different.

⑧ Motor Type (A, M)	Single Shaft (A)	With Electromagnetic Brake (M)	
⑥ Stroke	50 mm (005)	981.00 €	1,209.00 €
	100 mm (010)	981.00 €	1,209.00 €
	150 mm (015)	1,008.00 €	1,236.00 €
	200 mm (020)	1,008.00 €	1,236.00 €
	250 mm (025)	1,036.00 €	1,252.00 €
	300 mm (030)	1,036.00 €	1,252.00 €
	350 mm (035)	1,056.00 €	1,280.00 €
	400 mm (040)	1,056.00 €	1,280.00 €
	450 mm (045)	1,082.00 €	1,307.00 €
	500 mm (050)	1,082.00 €	1,307.00 €
	550 mm (055)	1,110.00 €	1,333.00 €
	600 mm (060)	1,110.00 €	1,333.00 €
	650 mm (065)	1,137.00 €	1,361.00 €
	700 mm (070)	1,137.00 €	1,361.00 €
	750 mm (075)	1,155.00 €	1,387.00 €
	800 mm (080)	1,155.00 €	1,387.00 €
850 mm (085)	1,182.00 €	1,402.00 €	

Included

Type	Included	Operating Manual
Common to All Types		1 Copy

The drivers and cables to be combined with the actuators are the same as the *αSTEP* **AZ** Series.

αSTEP **AZ** Series brochure is available.

When selecting products, please also use the brochure.



System Configuration

- When an Electric Linear Slide with Electromagnetic Brake is Combined with a Built-in Controller Type Driver or with a Pulse Input Type Driver with RS-485 Communication

(The AC input and DC input are shown together. The product in the photograph is for AC input.)

An example of a configuration when I/O controlled using a built-in controller type driver or when controlled with RS-485 communication is shown below.

The electric linear slides, drivers, and connection cable sets/flexible connection cable sets must be ordered separately.

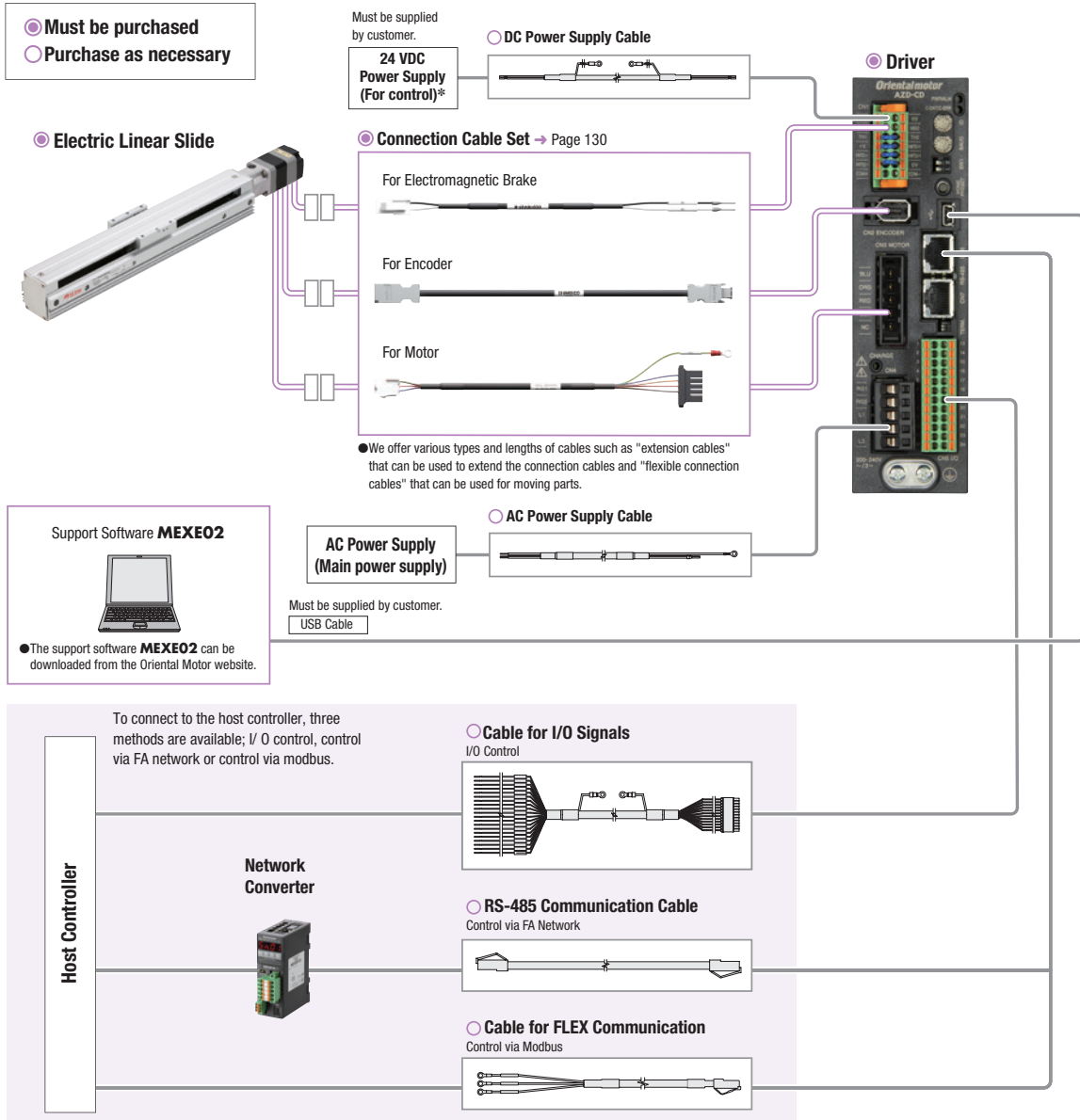

Accessories for Actuator

Sensor Sets

They can be attached to the sensor rail.
→ Page 137

Accessories for Driver

Regeneration Resistor*

Driver Mounting Brackets

Connector Covers

*Not required for the DC input products.

Example of System Configuration Pricing

Electric Linear Slide	+	Driver	+	Cables
EAS4XD050AZMC		AZD-CD		Connection Cable Set (1 m)
1,003.00 €		528.00 €		CC010VZFB
1,003.00 €		528.00 €		46.00 €

The system configuration shown above is an example. Other combinations are also available.

Note

The motor cable and electromagnetic brake cable from the motor cannot be connected directly to the driver. When connecting to a driver, use a connection cable.

● When an Electric Linear Slide with Electromagnetic Brake is Combined with a Pulse Input Type Driver
(The AC input and DC input are shown together. The product in the photograph is for AC input.)

An example of a single-axis system configuration with the programmable controller (built-in pulse generator function) is shown below. The electric linear slides, drivers, and connection cable sets/flexible connection cable sets must be ordered separately.

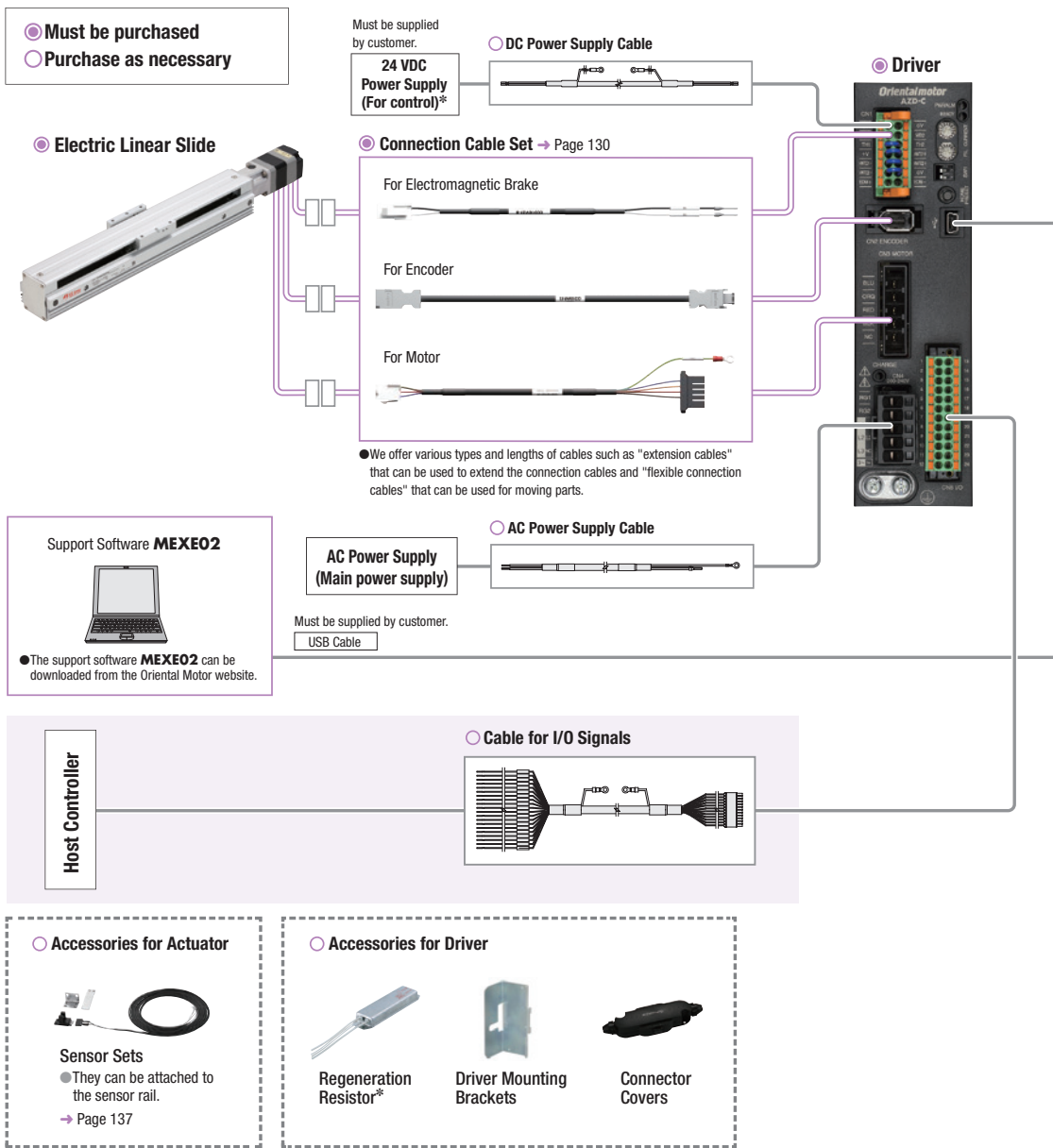

*Not required for the DC input products.

● **Example of System Configuration Pricing**

<p>Electric Linear Slide</p> <hr/> <p>EASM4XD050AZMC</p> <p>1,003.00 €</p> <p>○</p>	+	<p>Driver</p> <hr/> <p>AZD-C</p> <p>473.00 €</p> <p>○</p>	+	<p>Cables</p> <hr/> <p>Connection Cable Set (1 m)</p> <p>CC010VZFB</p> <p>46.00 €</p> <p>○</p>
--	---	--	---	---

● The system configuration shown above is an example. Other combinations are also available.

Note

● The motor cable and electromagnetic brake cable from the motor cannot be connected directly to the driver. When connecting to a driver, use a connection cable.

● When an Electric Linear Slide with Electromagnetic Brake is Combined with a Network Compatible Driver
(The AC input and DC input are shown together. The product in the photograph is for AC input.)

An example of a configuration when I/O controlled using an PROFINET Compatible driver or when controlled with PROFINET is shown below.

The electric linear slides, drivers, and connection cable sets/flexible connection cable sets must be ordered separately.

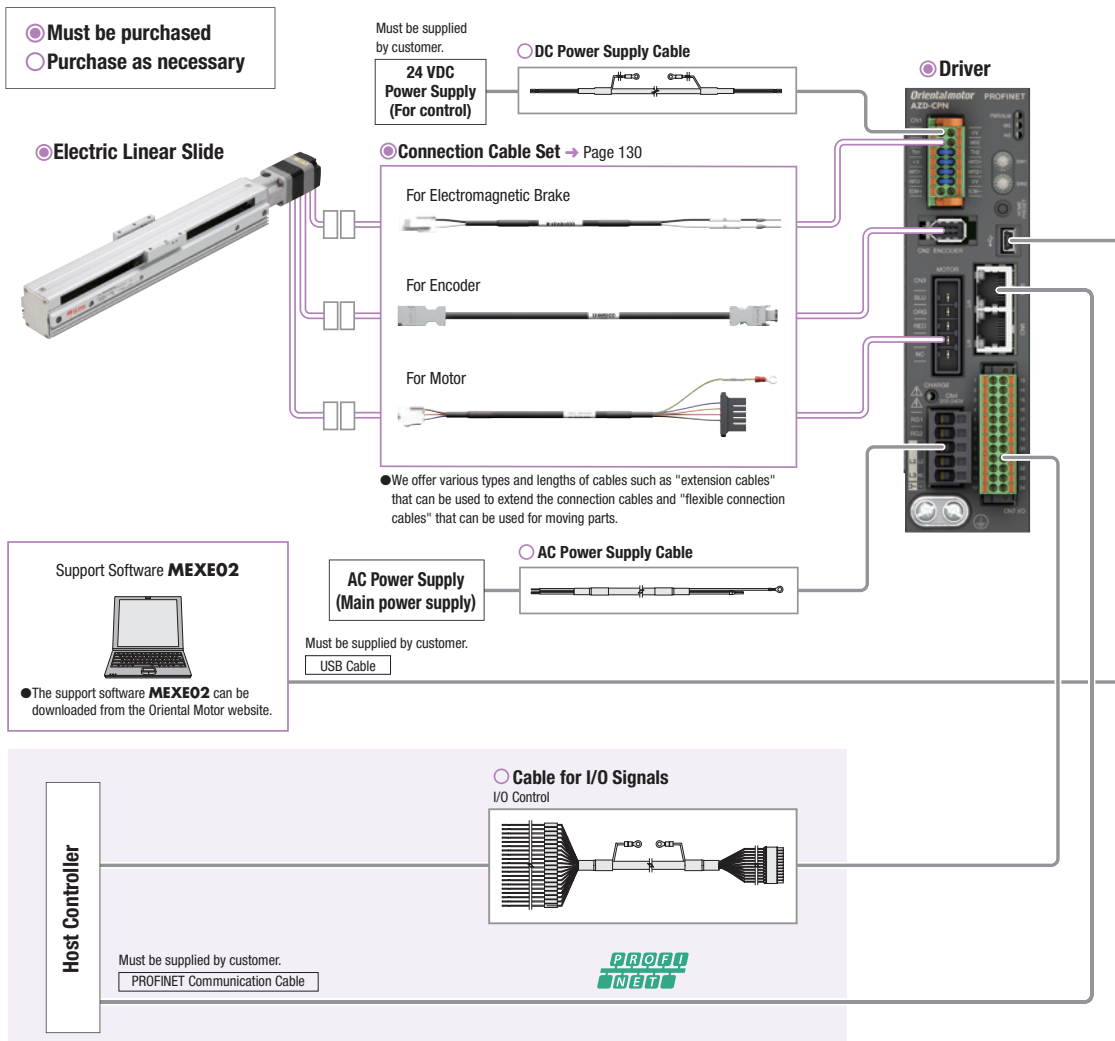

○ **Accessories for Actuator**

Sensor Sets
● They can be attached to the sensor rail.
→ Page 137

○ **Accessories for Driver**

Regeneration Resistor* **Driver Mounting Brackets** **Connector Covers**

*Not required for the DC input products.

● **Example of System Configuration Pricing**

<p>Electric Linear Slide</p> <p>EASM4XD050AZMC</p> <p>1,003.00 €</p> <p>○</p>	+	<p>Driver</p> <p>AZD-CEP</p> <p>572.00 €</p> <p>○</p>	+	<p>Cables</p> <p>Connection Cable Set (1 m)</p> <p>CC010VZFB</p> <p>46.00 €</p> <p>○</p>
--	---	--	---	---

● The system configuration shown above is an example. Other combinations are also available.

Note

● The motor cable and electromagnetic brake cable from the motor cannot be connected directly to the driver. When connecting to a driver, use a connection cable.

- Electric Linear Slides
- **QSTEP AZ Series Equipped EZS**
- **QSTEP AZ Series Equipped EAS**
- Electric Cylinders
- **QSTEP AZ Series Equipped EAC**
- Driver/ Connection cable
- Peripheral Equipment

EASM2: Width 30 mm × Height 38 mm Straight Type DC Input

Product Number

Model	Sensor Rail	Table Orientation	Lead Screw Pitch	Stroke	Equipped Motor	Motor Type	Motor Specifications
EASM2	N	X	E	005	AZ	A	K
EASM2	N: Without Sensor Rail Blank: With Sensor Rail	X: X-table Y: Y-table	E : 6 mm F : 3 mm	005: 50 mm 010: 100 mm 015: 150 mm ~ 030: 300 mm (50 mm increment)	AZ Series	A: Single Shaft	K: DC Input Specifications

Electric Linear Slide Specifications

Lead Screw Pitch		mm	6	3
Electromagnetic Brake (Power Off Activated Type)		Not equipped		
Drive Method		Ball Screw		
Repetitive Positioning Accuracy		mm	±0.02	
Minimum Travel Amount		mm	0.01	
Traveling Parallelism		mm	0.03	
Permissible Moment	Dynamic Permissible Moment	Nm	M _r : 2.4 M _v : 1.5 M _a : 4.6	
	Static Permissible Moment		M _r : 4.0 M _v : 4.0 M _a : 7.7	
Transportable Mass	Horizontal	kg	7.5 max.	15 max.
	Vertical		2.5 max.	5 max.
Thrust		N	25 max.	50 max.
Push Force		N	40	80
Holding Force		N	25	50
Maximum Speed		mm/s	300	150

- Since the holding force is lost when the power is not supplied, the load and external force cannot be held in the vertical direction.
When the product is used for operation in the vertical direction, provide protection external to the equipment.
- The maximum speed may decrease depending on the ambient temperature or the length of the motor cable.

Positioning Distance – Positioning Time

The positioning time (reference) can be checked from the positioning distance.

● Lead Screw Pitch 6 mm

◇ Horizontal Direction Installation

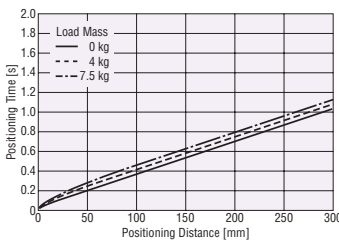

◇ Vertical Direction Installation

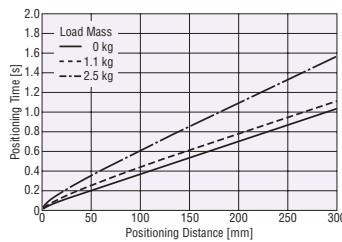

● Lead Screw Pitch 3 mm

◇ Horizontal Direction Installation

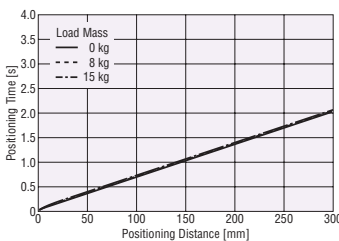

◇ Vertical Direction Installation

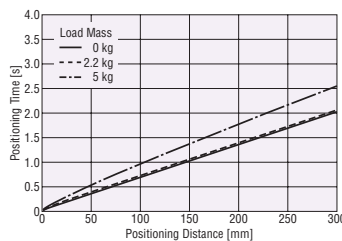

Note

- The starting speed should be 6 mm/s or less.

Operating Speed – Load Mass

● Horizontal Direction Installation

(Acceleration 3 m/s²)

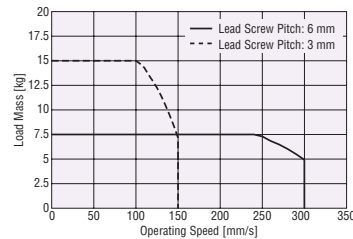

● Vertical Direction Installation (Acceleration 2 m/s²)

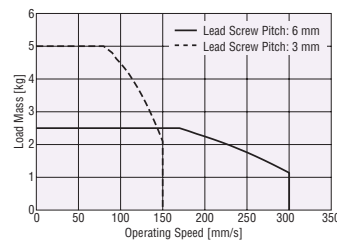

Dimensions

Electric Linear Slides → Page 71, 72

EASM4: Width 45 mm × Height 60 mm Straight Type AC Input

Electric Linear Slides
 QSTEP AZ Series Equipped EZS
 QSTEP AZ Series Equipped EAS

Electric Cylinders
 QSTEP AZ Series Equipped EAC

Driver/Connection cable

Peripheral Equipment

Product Number

Model	Sensor Rail	Table Orientation	Lead Screw Pitch	Stroke	Equipped Motor	Motor Type	Motor Specifications
EASM4	N	X	D	005	AZ	A	C
EASM4	N: Without Sensor Rail Blank: With Sensor Rail	X: X-table Y: Y-table	D: 12 mm E: 6 mm	005: 50 mm 010: 100 mm 015: 150 mm ~ 070: 700 mm (50 mm increment)	AZ Series	A: Single Shaft M: Electromagnetic Brake	C: AC Input Specifications

Electric Linear Slide Specifications

Lead Screw Pitch	mm	12	6		
Electromagnetic Brake (Power Off Activated Type)		Equipped	Not equipped	Equipped	Not equipped
Drive Method		Ball Screw			
Repetitive Positioning Accuracy	mm	±0.02			
Minimum Travel Amount	mm	0.01			
Traveling Parallelism	mm	0.03			
Permissible Moment	Dynamic Permissible Moment	M _r : 16.3 M _r : 4.8 M _r : 15.0			
	Static Permissible Moment	M _s : 58.3 M _s : 16.0 M _s : 53.3			
Transportable Mass	Horizontal	15 max.		30 max.	
	Vertical	7 max.	—	14 max.	—
Thrust	N	70 max.		140 max.	
Push Force	N	100		200	
Holding Force	N	70		140	
Maximum Speed by Stroke	50 to 500 mm	800		400	
	550 mm	650		320	
	600 mm	550		270	
	650 mm	460		220	
	700 mm	400		200	

● Since the holding force is lost when the power is not supplied, the load and external force cannot be held in the vertical direction. Select a product with an electromagnetic brake for operation in the vertical direction.

Operating Speed – Load Mass

Horizontal Direction Installation (Acceleration 3 m/s²)

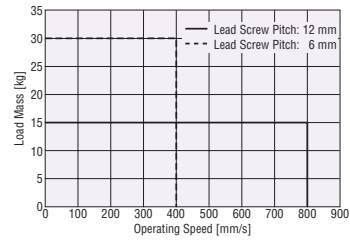

Vertical Direction Installation (Acceleration 2 m/s²)

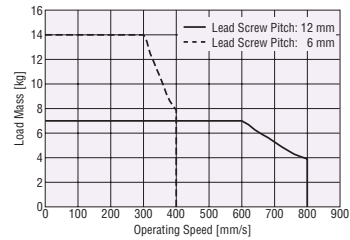

Positioning Distance – Positioning Time

The positioning time (reference) can be checked from the positioning distance.

A reference value for the positioning time can be calculated by multiplying the positioning time calculated from the graph with the positioning time coefficient for the applicable stroke.

Lead Screw Pitch 12 mm

Horizontal Direction Installation

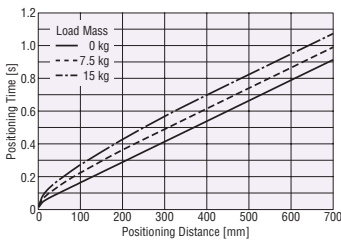

Vertical Direction Installation

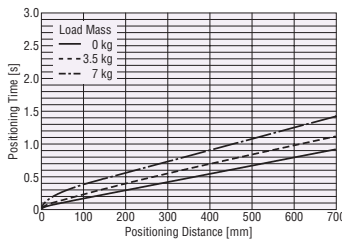

Positioning Time Coefficient

Stroke [mm]	Load Mass					
	Horizontal Direction Installation			Vertical Direction Installation		
	0 kg	7.5 kg	15 kg	0 kg	3.5 kg	7 kg
50 to 500	1.0	1.0	1.0	1.0	1.0	1.0
550	1.2	1.1	1.1	1.2	1.0	1.0
600	1.4	1.3	1.2	1.4	1.2	1.0
650	1.7	1.5	1.4	1.7	1.4	1.2
700	1.9	1.8	1.6	1.9	1.6	1.3

Lead Screw Pitch 6 mm

Horizontal Direction Installation

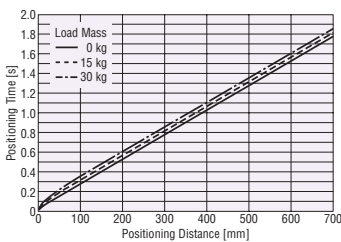

Vertical Direction Installation

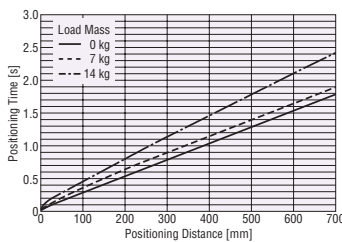

Positioning Time Coefficient

Stroke [mm]	Load Mass					
	Horizontal Direction Installation			Vertical Direction Installation		
	0 kg	15 kg	30 kg	0 kg	7 kg	14 kg
50 to 500	1.0	1.0	1.0	1.0	1.0	1.0
550	1.2	1.2	1.2	1.2	1.2	1.0
600	1.5	1.4	1.4	1.5	1.4	1.1
650	1.8	1.7	1.7	1.8	1.7	1.3
700	2.0	1.9	1.9	2.0	1.9	1.5

Note

● The starting speed should be 6 mm/s or less.

Dimensions Electric Linear Slides → Page 73, 75

EASM4: Width 45 mm × Height 60 mm Reversed Motor Type AC Input

Product Number

Model	Motor Orientation	Sensor Rail	Table Orientation	Lead Screw Pitch	Stroke	Equipped Motor	Motor Type	Motor Specifications
EASM4	L	N	X	D	005	AZ	A	C
EASM4	L: Reversed Motor Type (Left Side) R: Reversed Motor Type (Right Side)	N: Without Sensor Rail Blank: With Sensor Rail	X: X-table Y: Y-table	D: 12 mm E: 6 mm	005: 50 mm 010: 100 mm 015: 150 mm 070: 700 mm (50 mm increment)	AZ Series	A: Single Shaft M: With Electromagnetic Brake	C: AC Input Specifications

Electric Linear Slide Specifications

Lead Screw Pitch		mm	12		6	
Electromagnetic Brake (Power Off Activated Type)			Equipped	Not equipped	Equipped	Not equipped
Drive Method			Ball Screw			
Repetitive Positioning Accuracy		mm	±0.02			
Minimum Travel Amount		mm	0.01			
Traveling Parallelism		mm	0.03			
Permissible Moment	Dynamic Permissible Moment	Nm	M _r : 16.3 M _v : 4.8 M _R : 15.0			
	Static Permissible Moment		M _r : 58.3 M _v : 16.0 M _R : 53.3			
Transportable Mass	Horizontal	kg	15 max.		30 max.	
	Vertical		7 max.	—	12.5 max.	—
Thrust		N	70 max.		125 max.	
Push Force		N	100		200	
Holding Force		N	70		125	
Maximum Speed by Stroke	50 to 500 mm	mm/s	800		400	
	550 mm		650		320	
	600 mm		550		270	
	650 mm		460		220	
	700 mm		400		200	

● Since the holding force is lost when the power is not supplied, the load and external force cannot be held in the vertical direction. Select a product with an electromagnetic brake for operation in the vertical direction.

Operating Speed – Load Mass

Horizontal Direction Installation

(Acceleration 3 m/s²)

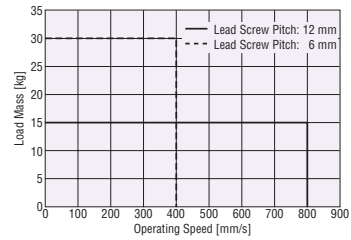

Vertical Direction Installation

(Acceleration 2 m/s²)

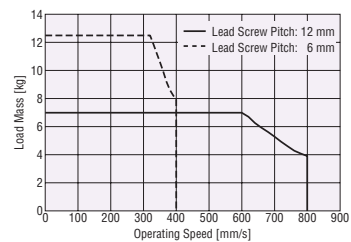

Positioning Distance – Positioning Time

The positioning time (reference) can be checked from the positioning distance.

A reference value for the positioning time can be calculated by multiplying the positioning time calculated from the graph with the positioning time coefficient for the applicable stroke.

Lead Screw Pitch 12 mm

Horizontal Direction Installation

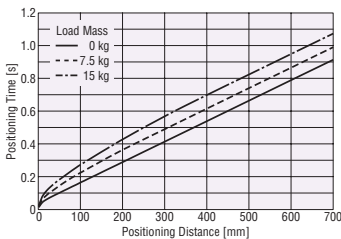

Vertical Direction Installation

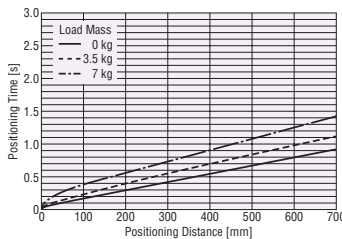

Lead Screw Pitch 6 mm

Horizontal Direction Installation

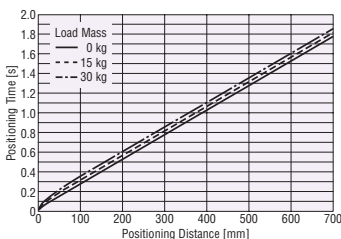

Vertical Direction Installation

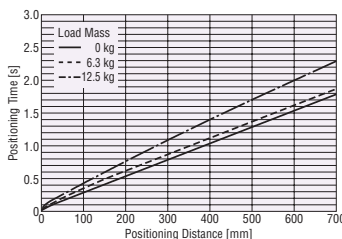

Note

● The starting speed should be 6 mm/s or less.

Positioning Time Coefficient

Stroke [mm]	Load Mass					
	Horizontal Direction Installation			Vertical Direction Installation		
	0 kg	7.5 kg	15 kg	0 kg	3.5 kg	7 kg
50 to 500	1.0	1.0	1.0	1.0	1.0	1.0
550	1.2	1.1	1.1	1.2	1.0	1.0
600	1.4	1.3	1.2	1.4	1.2	1.0
650	1.7	1.5	1.4	1.7	1.4	1.2
700	1.9	1.8	1.6	1.9	1.6	1.3

Positioning Time Coefficient

Stroke [mm]	Load Mass					
	Horizontal Direction Installation			Vertical Direction Installation		
	0 kg	15 kg	30 kg	0 kg	6.3 kg	12.5 kg
50 to 500	1.0	1.0	1.0	1.0	1.0	1.0
550	1.2	1.2	1.2	1.2	1.2	1.0
600	1.5	1.4	1.4	1.5	1.4	1.2
650	1.8	1.7	1.7	1.8	1.7	1.4
700	2.0	1.9	1.9	2.0	1.9	1.6

EASM4: Width 45 mm × Height 60 mm Straight Type DC Input

Electric Linear Slides
 QSTEP AZ Series Equipped EZS
 QSTEP AZ Series Equipped EAS

Electric Cylinders
 QSTEP AZ Series Equipped EAC

Driver/Connection cable

Peripheral Equipment

Product Number

Model	Sensor Rail	Table Orientation	Lead Screw Pitch	Stroke	Equipped Motor	Motor Type	Motor Specifications
EASM4	N	X	D	005	AZ	A	K
EASM4	N: Without Sensor Rail Blank: With Sensor Rail	X: X-table Y: Y-table	D: 12 mm E: 6 mm	005: 50 mm 010: 100 mm 015: 150 mm ~ 070: 700 mm (50 mm increment)	AZ Series	A: Single Shaft M: With Electromagnetic Brake	K: DC Input Specifications

Electric Linear Slide Specifications

Lead Screw Pitch	mm	12	6		
Electromagnetic Brake (Power Off Activated Type)		Equipped	Not equipped	Equipped	Not equipped
Drive Method		Ball Screw			
Repetitive Positioning Accuracy	mm	±0.02			
Minimum Travel Amount	mm	0.01			
Traveling Parallelism	mm	0.03			
Permissible Moment	Dynamic Permissible Moment	Mr: 16.3 Mr: 4.8 Mr: 15.0			
	Static Permissible Moment	Mr: 58.3 Mr: 16.0 Mr: 53.3			
Transportable Mass	Horizontal	15 max.		30 max.	
	Vertical	7 max.	—	14 max.	—
Thrust	N	70 max.		140 max.	
Push Force	N	100		200	
Holding Force	N	70		140	
Maximum Speed by Stroke	50 to 550 mm	600		300	
	600 mm	550		270	
	650 mm	460		220	
	700 mm	400		200	

- For specifications and characteristics of 48 VDC input products, contact your nearest sales office.
- Since the holding force is lost when the power is not supplied, the load and external force cannot be held in the vertical direction. Select a product with an electromagnetic brake for operation in the vertical direction.
- The maximum speed may decrease depending on the ambient temperature or the length of the motor cable.

Operating Speed – Load Mass

Horizontal Direction Installation

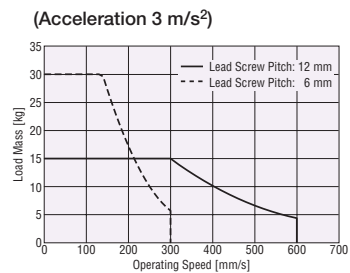

Vertical Direction Installation

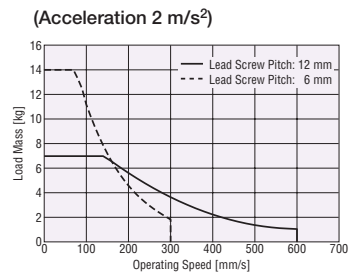

Positioning Distance – Positioning Time

The positioning time (reference) can be checked from the positioning distance.

A reference value for the positioning time can be calculated by multiplying the positioning time calculated from the graph with the positioning time coefficient for the applicable stroke.

Lead Screw Pitch 12 mm

Horizontal Direction Installation

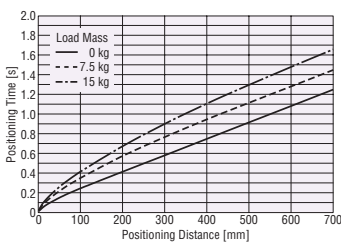

Vertical Direction Installation

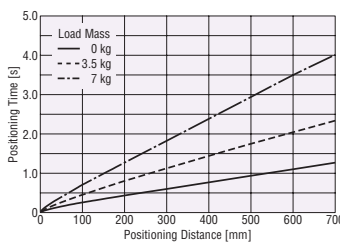

Positioning Time Coefficient

Stroke [mm]	Load Mass					
	Horizontal Direction Installation			Vertical Direction Installation		
	0 kg	7.5 kg	15 kg	0 kg	3.5 kg	7 kg
50 to 550	1.0	1.0	1.0	1.0	1.0	1.0
600	1.1	1.0	1.0	1.1	1.0	1.0
650	1.2	1.1	1.1	1.2	1.0	1.0
700	1.4	1.3	1.2	1.4	1.0	1.0

Lead Screw Pitch 6 mm

Horizontal Direction Installation

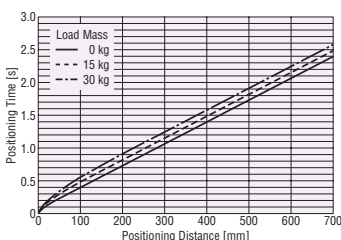

Vertical Direction Installation

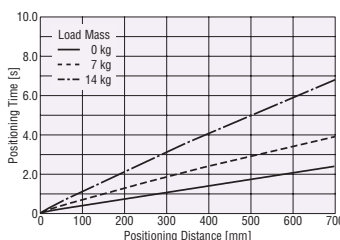

Positioning Time Coefficient

Stroke [mm]	Load Mass					
	Horizontal Direction Installation			Vertical Direction Installation		
	0 kg	15 kg	30 kg	0 kg	7 kg	14 kg
50 to 550	1.0	1.0	1.0	1.0	1.0	1.0
600	1.1	1.1	1.1	1.1	1.0	1.0
650	1.3	1.3	1.3	1.3	1.0	1.0
700	1.5	1.4	1.4	1.5	1.0	1.0

Note

- The starting speed should be 6 mm/s or less.

Dimensions Electric Linear Slides → Page 73, 75

EASM4: Width 45 mm × Height 60 mm Reversed Motor Type DC Input

Product Number

Model	Motor Orientation	Sensor Rail	Table Orientation	Lead Screw Pitch	Stroke	Equipped Motor	Motor Type	Motor Specifications
EASM4	L	N	X	D	005	AZ	A	K
EASM4	L: Reversed Motor Type (Left Side) R: Reversed Motor Type (Right Side)	N: Without Sensor Rail Blank: With Sensor Rail	X: X-table Y: Y-table	D: 12 mm E: 6 mm	005: 50 mm 010: 100 mm 015: 150 mm ~ 070: 700 mm (50 mm increment)	AZ Series	A: Single Shaft M: With Electromagnetic Brake	K: DC Input Specifications

Electric Linear Slide Specifications

Lead Screw Pitch	mm	12	6		
Electromagnetic Brake (Power Off Activated Type)		Equipped	Not equipped	Equipped	Not equipped
Drive Method		Ball Screw			
Repetitive Positioning Accuracy	mm	±0.02			
Minimum Travel Amount	mm	0.01			
Traveling Parallelism	mm	0.03			
Permissible Moment	Dynamic Permissible Moment	M _r : 16.3 M _r : 4.8 M _r : 15.0			
	Static Permissible Moment	M _r : 58.3 M _r : 16.0 M _r : 53.3			
Transportable Mass	Horizontal	15 max.		30 max.	
	Vertical	7 max.	—	12.5 max.	—
Thrust	N	70 max.		125 max.	
Push Force	N	100		200	
Holding Force	N	70		125	
Maximum Speed by Stroke	50 to 550 mm	600		300	
	600 mm	550		270	
	650 mm	460		220	
	700 mm	400		200	

- For specifications and characteristics of 48 VDC input products, contact your nearest sales office.
- Since the holding force is lost when the power is not supplied, the load and external force cannot be held in the vertical direction. Select a product with an electromagnetic brake for operation in the vertical direction.
- The maximum speed may decrease depending on the ambient temperature or the length of the motor cable.

Positioning Distance – Positioning Time

The positioning time (reference) can be checked from the positioning distance.

A reference value for the positioning time can be calculated by multiplying the positioning time calculated from the graph with the positioning time coefficient for the applicable stroke.

● Lead Screw Pitch 12 mm

◇ Horizontal Direction Installation

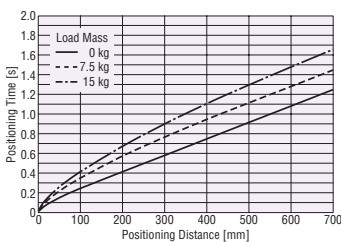

◇ Vertical Direction Installation

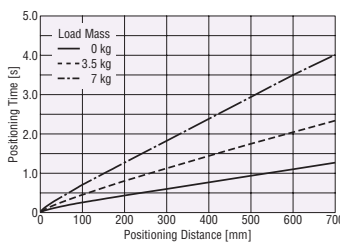

● Lead Screw Pitch 6 mm

◇ Horizontal Direction Installation

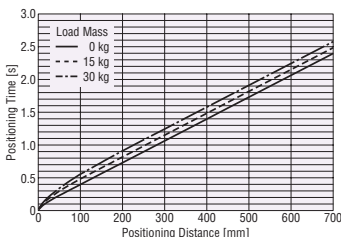

◇ Vertical Direction Installation

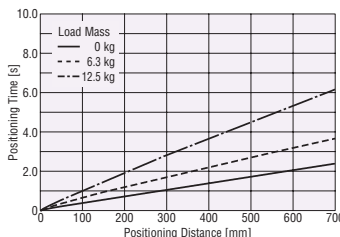

Note

- The starting speed should be 6 mm/s or less.

Dimensions Electric Linear Slides → Page 74, 76

Operating Speed – Load Mass

● Horizontal Direction Installation

(Acceleration 3 m/s²)

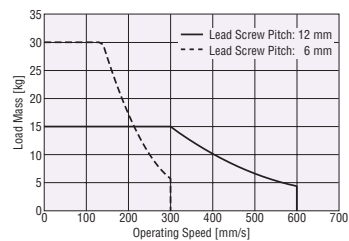

● Vertical Direction Installation

(Acceleration 2 m/s²)

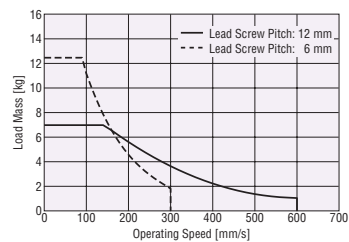

Positioning Time Coefficient

Stroke [mm]	Load Mass					
	Horizontal Direction Installation			Vertical Direction Installation		
	0 kg	7.5 kg	15 kg	0 kg	3.5 kg	7 kg
50 to 550	1.0	1.0	1.0	1.0	1.0	1.0
600	1.1	1.0	1.0	1.1	1.0	1.0
650	1.2	1.1	1.1	1.2	1.0	1.0
700	1.4	1.3	1.2	1.4	1.0	1.0

Positioning Time Coefficient

Stroke [mm]	Load Mass					
	Horizontal Direction Installation			Vertical Direction Installation		
	0 kg	15 kg	30 kg	0 kg	6.3 kg	12.5 kg
50 to 550	1.0	1.0	1.0	1.0	1.0	1.0
600	1.1	1.1	1.1	1.1	1.0	1.0
650	1.3	1.3	1.3	1.3	1.0	1.0
700	1.5	1.4	1.4	1.5	1.0	1.0

EASM6: Width 62 mm × Height 83 mm Straight Type Revered Motor Type AC Input

Electric Linear Slides
 QSTEP AZ Series Equipped EZS
 QSTEP AZ Series Equipped EAS

Electric Cylinders
 QSTEP AZ Series Equipped EAC

Driver/ Connection cable

Peripheral Equipment

Product Number

Model	Motor Orientation	Sensor Rail	Table Orientation	Lead Screw Pitch	Stroke	Equipped Motor	Motor Type	Motor Specifications
EASM6	L	N	X	D	005	AZ	A	C
EASM6	L: Reversed Motor Type (Left Side) R: Reversed Motor Type (Right Side) Blank: Straight Type	N: Without Sensor Rail Blank: With Sensor Rail	X: X-table Y: Y-table	D: 12 mm E: 6 mm	005: 50 mm 010: 100 mm 015: 150 mm ~ 085: 850 mm (50 mm increment)	AZ Series	A: Single Shaft M: With Electromagnetic Brake	C: AC Input Specifications

Electric Linear Slide Specifications

Lead Screw Pitch	mm	12	6	
Electromagnetic Brake (Power Off Activated Type)	Equipped	Not equipped	Equipped	Not equipped
Drive Method	Ball Screw			
Repetitive Positioning Accuracy	mm	±0.02		
Minimum Travel Amount	mm	0.01		
Traveling Parallelism	mm	0.03		
Permissible Moment	Dynamic Permissible Moment	M _P : 31.8 M _r : 10.3 M _R : 40.6		
	Static Permissible Moment	M _P : 86.0 M _r : 34.0 M _R : 110.0		
Transportable Mass	Horizontal	30 max.		60 max.
	Vertical	15 max.	—	30 max.
Thrust	N	200 max.	400 max. [360 max.]	
Push Force	N	400	500	
Holding Force	N	200	400 [360]	
	mm/s	200	400	350
Maximum Speed by Stroke	50 to 550 mm	800	400	350
	600 mm	640	300	260
	650 mm	550	230	200
	700 mm	470	180	180
	750 mm	420	180	180
	800 mm	360	180	180

- The parentheses [] indicate the specifications for the reversed motor type.
- Since the holding force is lost when the power is not supplied, the load and external force cannot be held in the vertical direction. Select a product with an electromagnetic brake for operation in the vertical direction.

Operating Speed – Load Mass

Horizontal Direction Installation (Acceleration 3 m/s²)

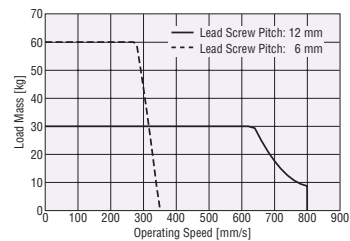

Vertical Direction Installation (Acceleration 2 m/s²)

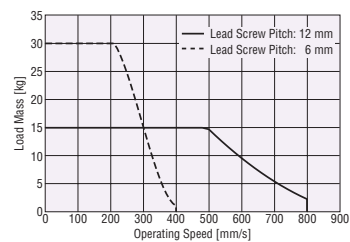

Positioning Distance – Positioning Time

The positioning time (reference) can be checked from the positioning distance.

A reference value for the positioning time can be calculated by multiplying the positioning time calculated from the graph with the positioning time coefficient for the applicable stroke.

Lead Screw Pitch 12 mm

Horizontal Direction Installation

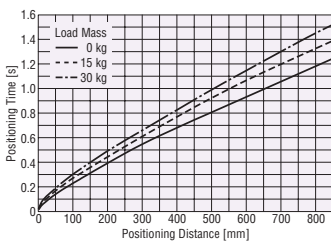

Vertical Direction Installation

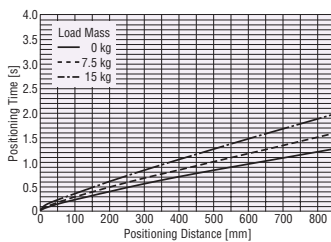

Lead Screw Pitch 6 mm

Horizontal Direction Installation

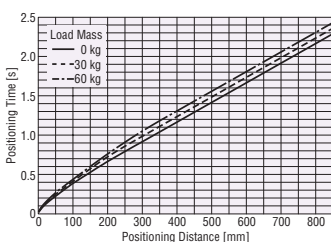

Vertical Direction Installation

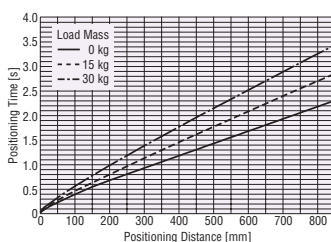

Note

- The starting speed should be 6 mm/s or less.

Positioning Time Coefficient

Stroke [mm]	Load Mass					
	Horizontal Direction Installation			Vertical Direction Installation		
	0 kg	15 kg	30 kg	0 kg	7.5 kg	15 kg
50 to 600	1.0	1.0	1.0	1.0	1.0	1.0
650	1.1	1.0	1.0	1.1	1.0	1.0
700	1.3	1.1	1.0	1.2	1.1	1.0
750	1.5	1.3	1.2	1.4	1.2	1.0
800	1.6	1.5	1.4	1.6	1.3	1.1
850	1.9	1.7	1.6	1.9	1.5	1.2

Positioning Time Coefficient

Stroke [mm]	Load Mass					
	Horizontal Direction Installation			Vertical Direction Installation		
	0 kg	30 kg	60 kg	0 kg	15 kg	30 kg
50 to 550	1.0	1.0	1.0	1.0	1.0	1.0
600	1.1	1.1	1.1	1.1	1.0	1.0
650	1.2	1.2	1.2	1.2	1.0	1.0
700	1.4	1.4	1.3	1.4	1.2	1.0
750	1.6	1.6	1.5	1.6	1.3	1.1
800	1.9	1.8	1.7	1.8	1.5	1.3
850	2.1	2.0	2.0	2.1	1.7	1.4

EASM6: Width 62 mm × Height 83 mm Straight Type Revered Motor Type DC Input

Product Number

Model	Motor Orientation	Sensor Rail	Table Orientation	Lead Screw Pitch	Stroke	Equipped Motor	Motor Type	Motor Specifications
EASM6	L	N	X	D	005	AZ	A	K
EASM6	L: Reversed Motor Type (Left Side) R: Reversed Motor Type (Right Side) Blank: Straight Type	N: Without Sensor Rail Blank: With Sensor Rail	X: X-table Y: Y-table	D: 12 mm E: 6 mm	005: 50 mm 010: 100 mm 015: 150 mm ~ 085: 850 mm (50 mm increment)	AZ Series	A: Single Shaft M: With Electromagnetic Brake	K: DC Input Specifications

Electric Linear Slide Specifications

Lead Screw Pitch	mm	12	6		
Electromagnetic Brake (Power Off Activated Type)		Equipped	Not equipped	Equipped	Not equipped
Drive Method		Ball Screw			
Repetitive Positioning Accuracy	mm	±0.02			
Minimum Travel Amount	mm	0.01			
Traveling Parallelism	mm	0.03			
Permissible Moment	Dynamic Permissible Moment	M _r : 31.8 M _v : 10.3 M _a : 40.6			
	Static Permissible Moment	M _r : 86.0 M _v : 34.0 M _a : 110.0			
Transportable Mass	Horizontal	30 max.		60 max.	
	Vertical	15 max.	—	30 max.	—
Thrust	N	200 max.		400 max. [360 max.]	
Push Force	N	400		500	
Holding Force	50 to 650 mm	600		300	
	700 mm	550		260	
Maximum Speed by Stroke	750 mm	470		230	
	800 mm	420		200	
	850 mm	360		180	

- The parentheses [] indicate the specifications for the reversed motor type.
- For specifications and characteristics of 48 VDC input products, contact your nearest sales office.
- Since the holding force is lost when the power is not supplied, the load and external force cannot be held in the vertical direction. Select a product with an electromagnetic brake for operation in the vertical direction.
- The maximum speed may decrease depending on the ambient temperature or the length of the motor cable.

Positioning Distance – Positioning Time

The positioning time (reference) can be checked from the positioning distance.

A reference value for the positioning time can be calculated by multiplying the positioning time calculated from the graph with the positioning time coefficient for the applicable stroke.

● Lead Screw Pitch 12 mm

◇ Horizontal Direction Installation

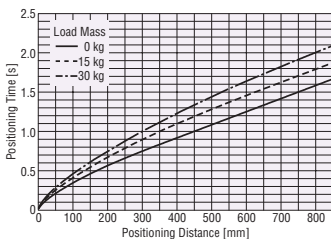

◇ Vertical Direction Installation

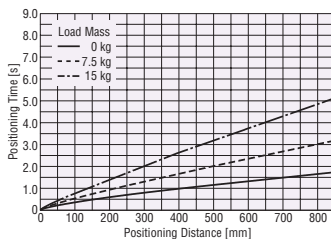

● Lead Screw Pitch 6 mm

◇ Horizontal Direction Installation

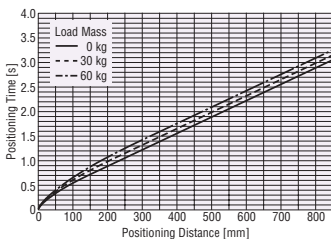

◇ Vertical Direction Installation

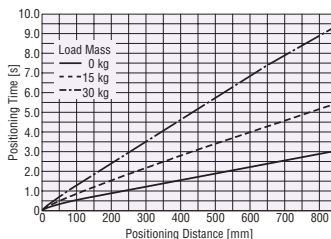

Note

- The starting speed should be 6 mm/s or less.

Dimensions Electric Linear Slides → Page 77-80

Operating Speed – Load Mass

● Horizontal Direction Installation (Acceleration 3 m/s²)

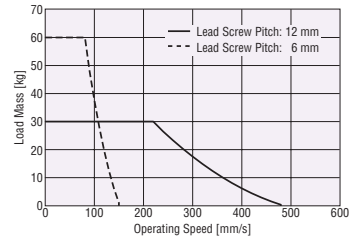

● Vertical Direction Installation (Acceleration 2 m/s²)

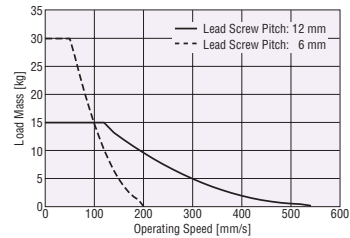

Positioning Time Coefficient

Stroke [mm]	Load Mass					
	Horizontal Direction Installation			Vertical Direction Installation		
	0 kg	15 kg	30 kg	0 kg	7.5 kg	15 kg
50 to 650	1.0	1.0	1.0	1.0	1.0	1.0
700	1.0	1.0	1.0	1.0	1.0	1.0
750	1.2	1.1	1.0	1.1	1.0	1.0
800	1.3	1.2	1.1	1.2	1.0	1.0
850	1.5	1.3	1.2	1.4	1.0	1.0

Positioning Time Coefficient

Stroke [mm]	Load Mass					
	Horizontal Direction Installation			Vertical Direction Installation		
	0 kg	30 kg	60 kg	0 kg	15 kg	30 kg
50 to 650	1.0	1.0	1.0	1.0	1.0	1.0
700	1.1	1.1	1.1	1.1	1.0	1.0
750	1.2	1.2	1.2	1.2	1.0	1.0
800	1.4	1.4	1.3	1.4	1.0	1.0
850	1.6	1.5	1.5	1.6	1.0	1.0

Electromagnetic Brake Specification

Product Name	EASM4	EASM6
Brake Type	Power Off Activated Type	
Power Supply Voltage	24 V DC \pm 5%*	
Power Supply Current	0.08	0.25
Time Rating	Continuous	

*For the type with an electromagnetic brake, 24 VDC \pm 4% specification applies if the wiring distance between the motor and driver is extended to 20 m using a cable (sold separately).

General Specifications

		AC Input	DC Input
Thermal Class		130 (B) [UL/CSA: 105 (A)]	
Insulation Resistance		100 M Ω or more when a 500 VDC megger is applied between the following places: <ul style="list-style-type: none"> · Case – Motor Windings · Case – Electromagnetic Brake Windings*1 	
Dielectric Strength		Sufficient to withstand the following for 1 minute: EASM4, EASM6 <ul style="list-style-type: none"> · Case – Motor Windings 1.5 kVAC, 50 Hz or 60 Hz · Case – Electromagnetic Brake Windings*1 1.5 kVAC, 50 Hz or 60 Hz 	Sufficient to withstand the following for 1 minute: EASM2 <ul style="list-style-type: none"> · Case – Motor Windings 0.5 kVAC, 50 Hz or 60 Hz EASM4, EASM6 <ul style="list-style-type: none"> · Case – Motor Windings 1.0 kVAC, 50 Hz or 60 Hz · Case – Electromagnetic Brake Windings*1 1.0 kVAC, 50 Hz or 60 Hz
Operating Environment (In operation)	Ambient Temperature	0 to +40°C (Non-freezing)*3	
	Ambient Humidity	85% or less (Non-condensing)	
	Atmosphere	No corrosive gases or dust. The product should not be exposed to water, oil or other liquids.	
Degree of Protection*2		EASM2 : IP40 (excluding installation surfaces and connector locations) EASM4, EASM6 : IP66 (excluding installation surfaces and connector locations)	
Multiple Rotation Detection Range in Power OFF State		EASM2 : \pm 450 Rotations (900 Rotations) EASM4, EASM6 : \pm 900 Rotations (1800 Rotations)	

*1 Only for products with an electromagnetic brake.

*2 Only for motor parts. The degree of protection of the electric linear slide is IP00.

*3 It is based on Oriental Motor's measurement conditions.

Note

- Disconnect the motor and driver when taking an insulation resistance measurement or performing a dielectric voltage withstand test. Also, do not perform these tests on the absolute sensor part of the motor.

Electric Linear Slides

QSTEP AZ Series Equipped EZS

QSTEP AZ Series Equipped EAS

Electric Cylinders

QSTEP AZ Series Equipped EAC

Driver/Connection cable

Peripheral Equipment

Travel Direction

At the time of shipment, the travel direction of the table is set as follows.

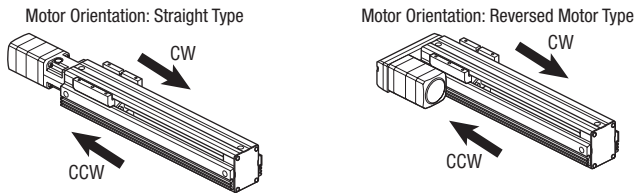

Installation of the Actuator

Note the installation location as the absolute sensor is easily affected by magnetism.

Installation of EASM2

When installing the motors side by side, separate them horizontally or vertically at a distance greater than the size (frame size) of the other motor.

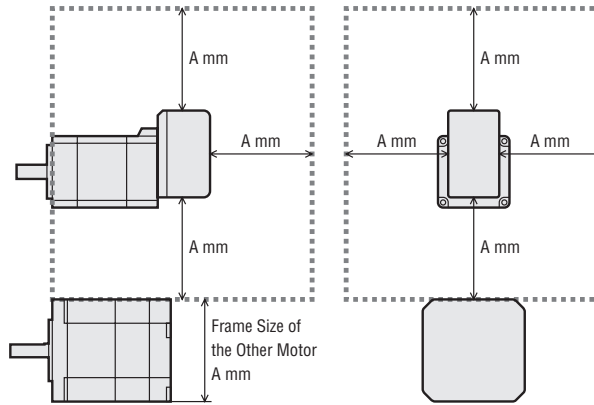

● Reference

The Other Motor	A
Frame Size 20 mm	20
Frame Size 28 mm	28
Frame Size 42 mm	42
Frame Size 60 mm	60

When installing the actuator in an environment where a magnetic field is generated

Make sure that the magnetic flux density on the surface of the absolute sensor does not exceed the values in the table.

Product Name	Magnetic Flux Density
EASM2	2 mT*
EASM4, EASM6	10 mT

*When the magnetic flux density exceeding 1 mT and below 2 mT, please use the actuator at ambient temperature exceeding 20°C and below 40°C.

Dimensions (Unit: mm)

● EASM2 Straight Type X-Table With Sensor Rail / Without Sensor Rail

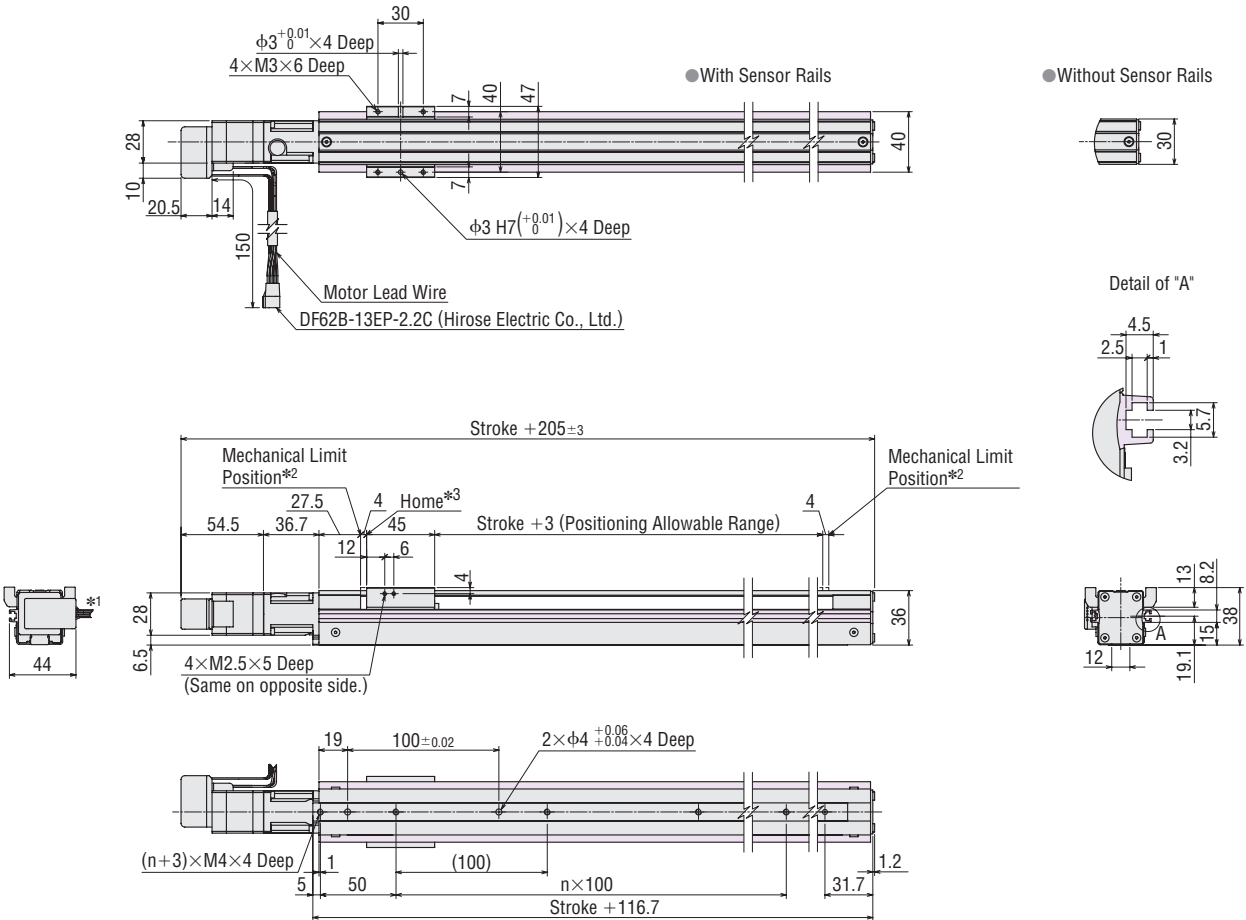

*1 The motor cable outlet direction can be changed in 90° intervals in four directions.

*2 During the pushing return-to-home operation, the table moves to actuator end.

*3 When using an accessory sensor, the home position differs.

Stroke [mm]	50	100	150	200	250	300	
Hole Coefficient (n)	0	1	1	2	2	3	
Mass [kg]	Single shaft	0.64	0.70	0.77	0.84	0.92	0.99

Electric
Linear
Slides

QSTEP
AZ Series
Equipped
EAS

QSTEP
AZ Series
Equipped
EAS

Electric
Cylinders

QSTEP
AZ Series
Equipped
EAC

Driver/
Connection
cable

Peripheral
Equipment

● EASM2 Straight Type Y-Table With Sensor Rail / Without Sensor Rail

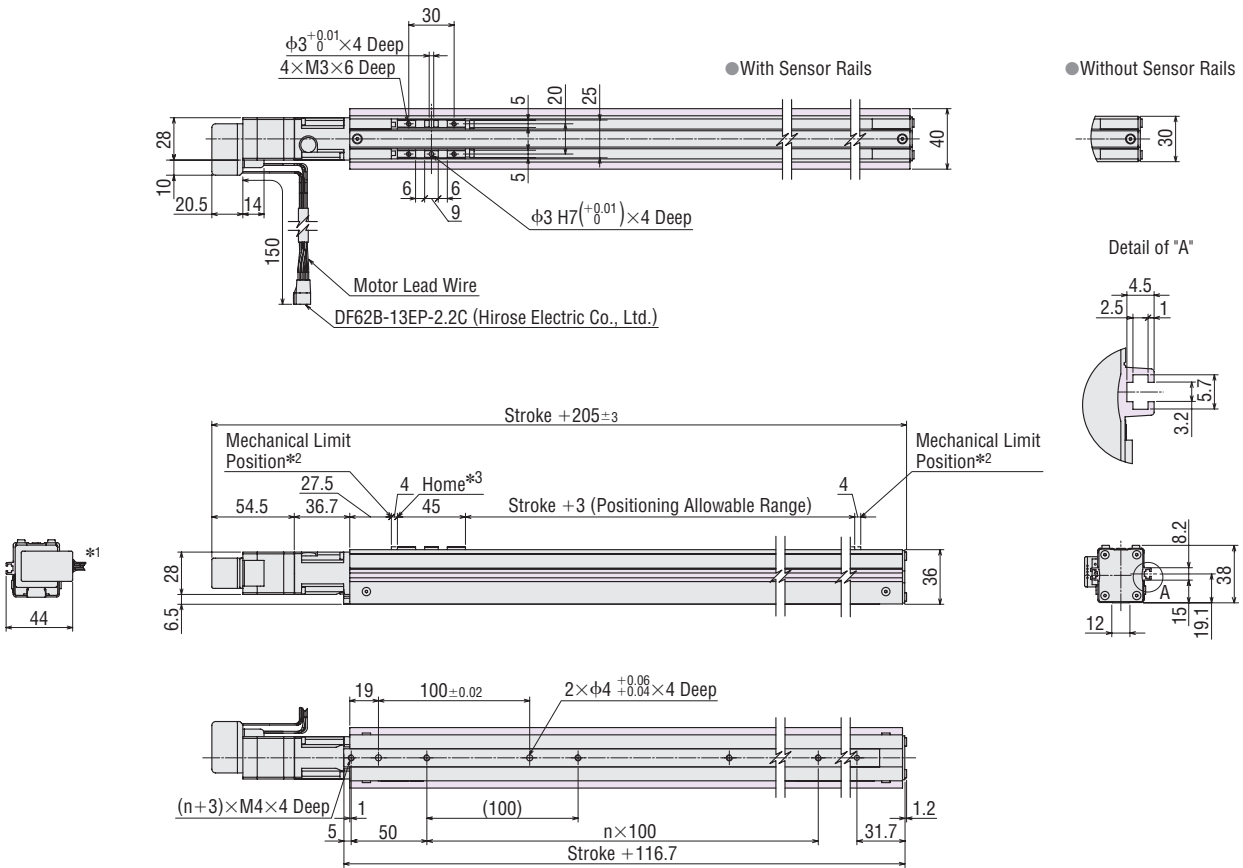

- *1 The motor cable outlet direction can be changed in 90° intervals in four directions.
- *2 During the pushing return-to-home operation, the table moves to actuator end.
- *3 When using an accessory sensor, the home position differs.

Stroke [mm]	50	100	150	200	250	300	
Hole Coefficient (n)	0	1	1	2	2	3	
Mass [kg]	Single shaft	0.64	0.70	0.77	0.84	0.92	0.99

● **EASM4 Straight Type X-Table With Sensor Rail / Without Sensor Rail**

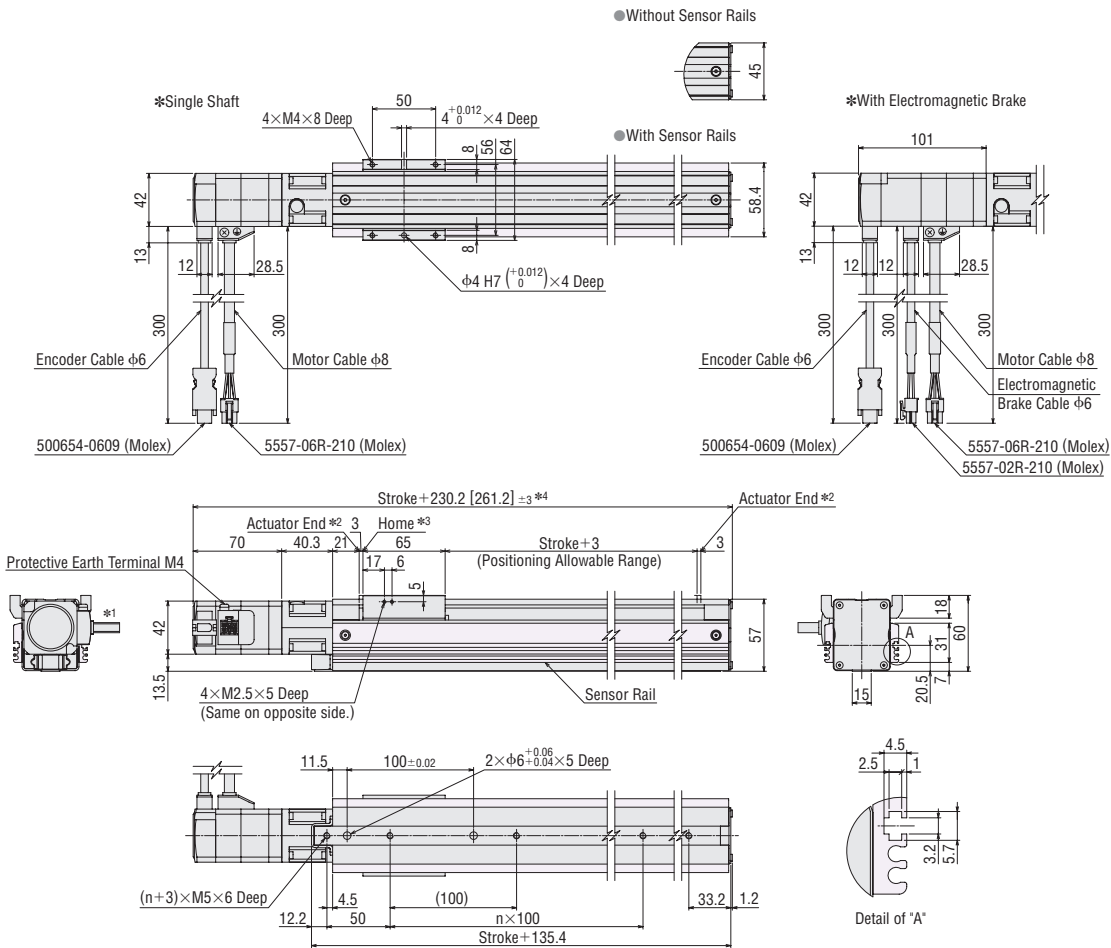

- *1 The motor cable outlet direction can be changed in 90° intervals in four directions.
- *2 During the pushing return-to-home operation, the table moves to actuator end.
- *3 When using an accessory sensor, the home position differs.
- *4 The brackets [] indicate the values for the electromagnetic brake product.

Stroke [mm]		50	100	150	200	250	300	350	400	450	500	550	600	650	700	
Hole Coefficient (n)		1	1	2	2	3	3	4	4	5	5	6	6	7	7	
Mass [kg]	With Sensor Rails	Single shaft	1.8	1.9	2.1	2.2	2.4	2.5	2.7	2.9	3.0	3.2	3.4	3.5	3.7	3.8
		With electromagnetic brake	2.0	2.1	2.3	2.4	2.6	2.7	2.9	3.1	3.2	3.4	3.6	3.7	3.9	4.0
	Without Sensor Rails	Single shaft	1.6	1.7	1.9	2.0	2.1	2.2	2.3	2.5	2.6	2.7	2.8	2.9	3.0	3.2
		With electromagnetic brake	1.8	1.9	2.1	2.2	2.3	2.4	2.5	2.7	2.8	2.9	3.0	3.1	3.2	3.4

Electric Linear Slides

Q-STEP AZ Series Equipped EZS

Q-STEP AZ Series Equipped EAS

Electric Cylinders

Q-STEP AZ Series Equipped EAC

Driver/ Connection cable

Peripheral Equipment

● **EASM4 Reversed Motor Type (Left Side) X-Table With Sensor Rail / Without Sensor Rail**

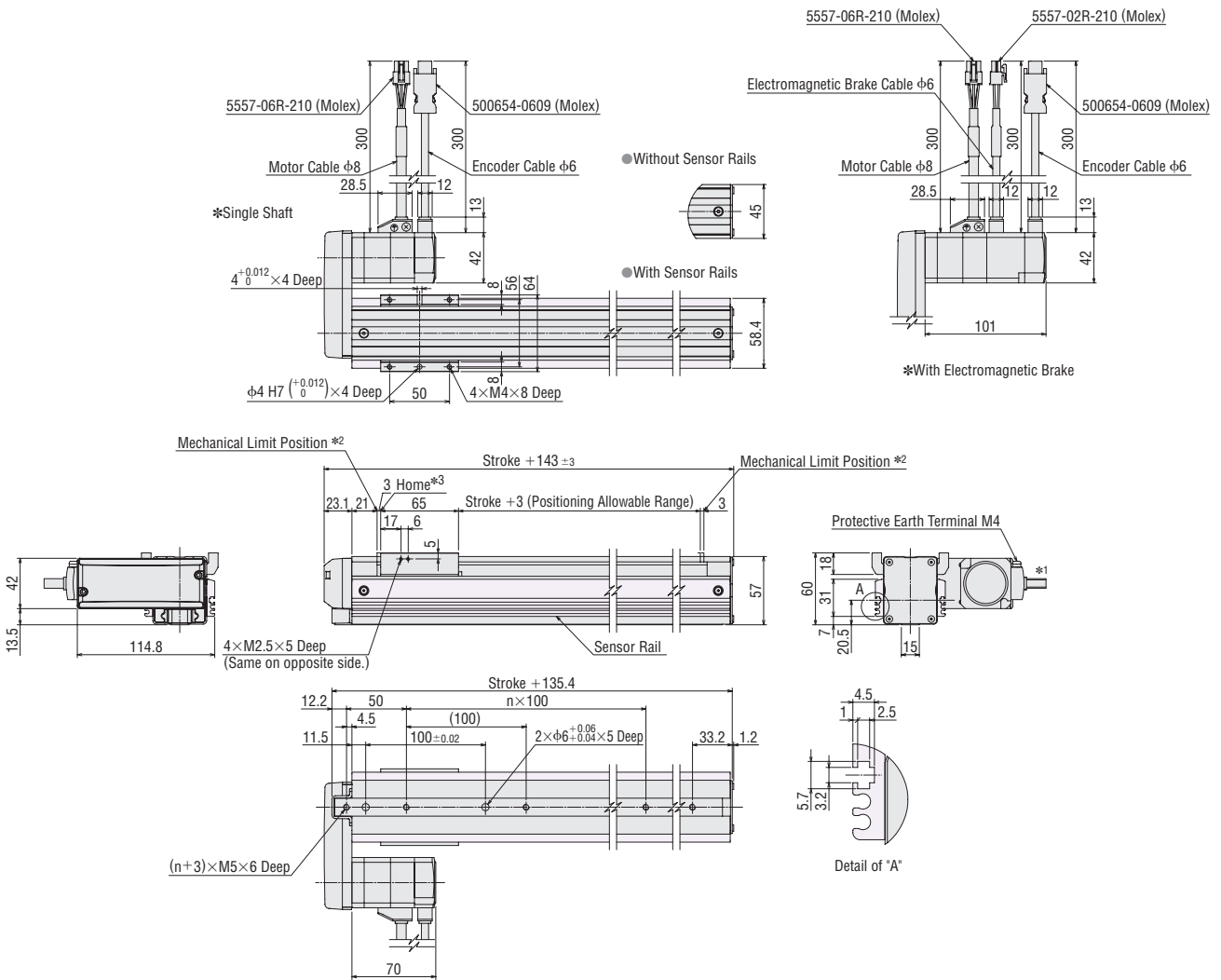

*1 The motor cable outlet direction can be changed in 90° intervals in three directions.

*2 During the pushing return-to-home operation, the table moves to actuator end.

*3 When using an accessory sensor, the home position differs.

● The figure above is for the left reversed motor type. For the right reversed motor type, the motor is located on the opposite side with the slider part center.

Stroke [mm]		50	100	150	200	250	300	350	400	450	500	550	600	650	700	
Hole Coefficient (n)		1	1	2	2	3	3	4	4	5	5	6	6	7	7	
Mass [kg]	With Sensor Rails	Single shaft	1.8	1.9	2.1	2.2	2.4	2.5	2.7	2.9	3.0	3.2	3.4	3.5	3.7	3.8
		With electromagnetic brake	2.0	2.1	2.3	2.4	2.6	2.7	2.9	3.1	3.2	3.4	3.6	3.7	3.9	4.0
	Without Sensor Rails	Single shaft	1.6	1.7	1.9	2.0	2.1	2.2	2.3	2.5	2.6	2.7	2.8	2.9	3.0	3.2
		With electromagnetic brake	1.8	1.9	2.1	2.2	2.3	2.4	2.5	2.7	2.8	2.9	3.0	3.1	3.2	3.4

● **EASM4 Straight Type Y-Table With Sensor Rail / Without Sensor Rail**

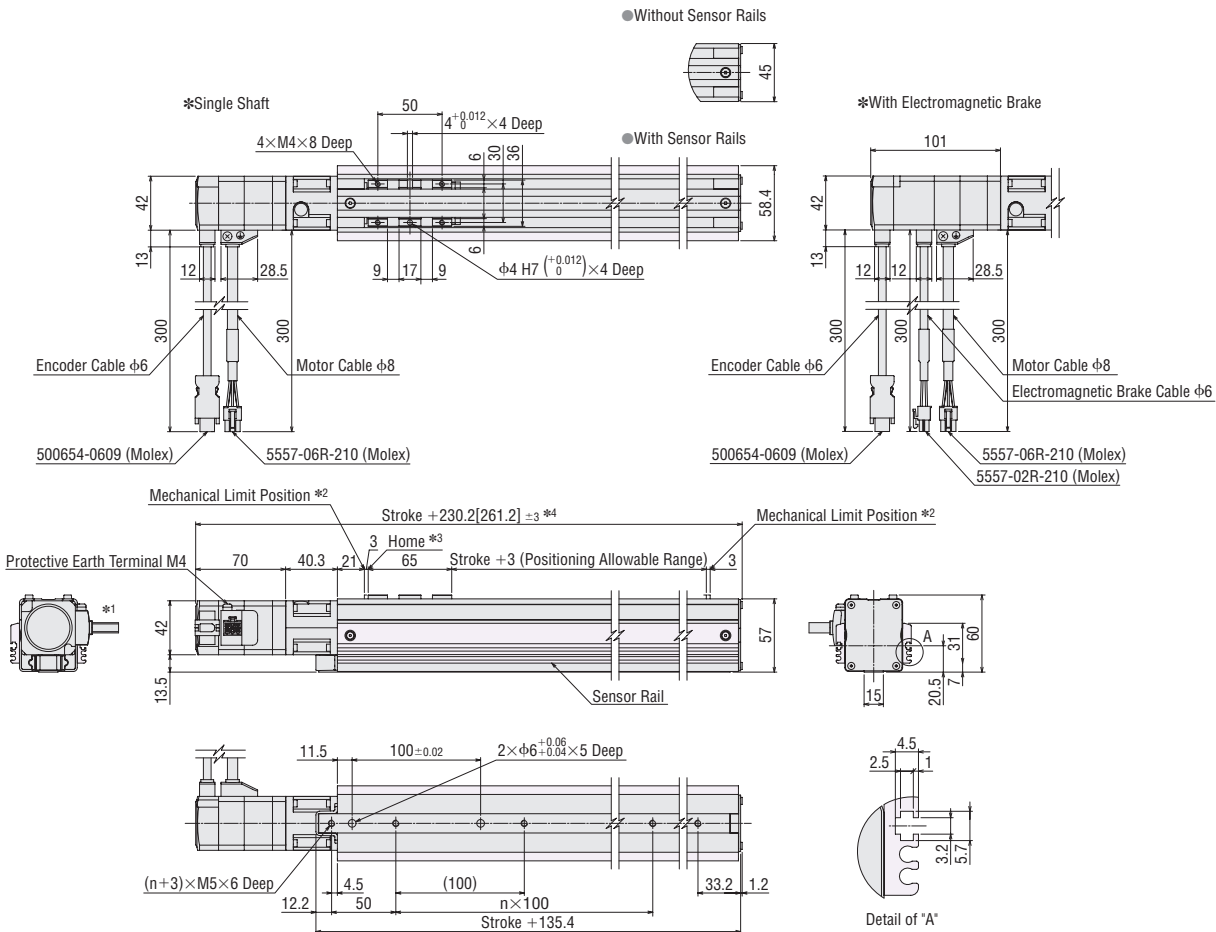

- *1 The motor cable outlet direction can be changed in 90° intervals in four directions.
- *2 During the pushing return-to-home operation, the table moves to actuator end.
- *3 When using an accessory sensor, the home position differs.
- *4 The brackets [] indicate the values for the electromagnetic brake product.

Stroke [mm]		50	100	150	200	250	300	350	400	450	500	550	600	650	700	
Hole Coefficient (n)		1	1	2	2	3	3	4	4	5	5	6	6	7	7	
Mass [kg]	With Sensor Rails	Single shaft	1.8	1.9	2.1	2.2	2.4	2.5	2.7	2.9	3.0	3.2	3.4	3.5	3.7	3.8
		With electromagnetic brake	2.0	2.1	2.3	2.4	2.6	2.7	2.9	3.1	3.2	3.4	3.6	3.7	3.9	4.0
	Without Sensor Rails	Single shaft	1.6	1.7	1.9	2.0	2.1	2.2	2.3	2.5	2.6	2.7	2.8	2.9	3.0	3.2
		With electromagnetic brake	1.8	1.9	2.1	2.2	2.3	2.4	2.5	2.7	2.8	2.9	3.0	3.1	3.2	3.4

Electric Linear Slides

QSTEP AZ Series Equipped EZS

QSTEP AZ Series Equipped EAS

Electric Cylinders

QSTEP AZ Series Equipped EAC

Driver/ Connection cable

Peripheral Equipment

● **EASM4 Reversed Motor Type (Left Side) Y-Table With Sensor Rail / Without Sensor Rail**

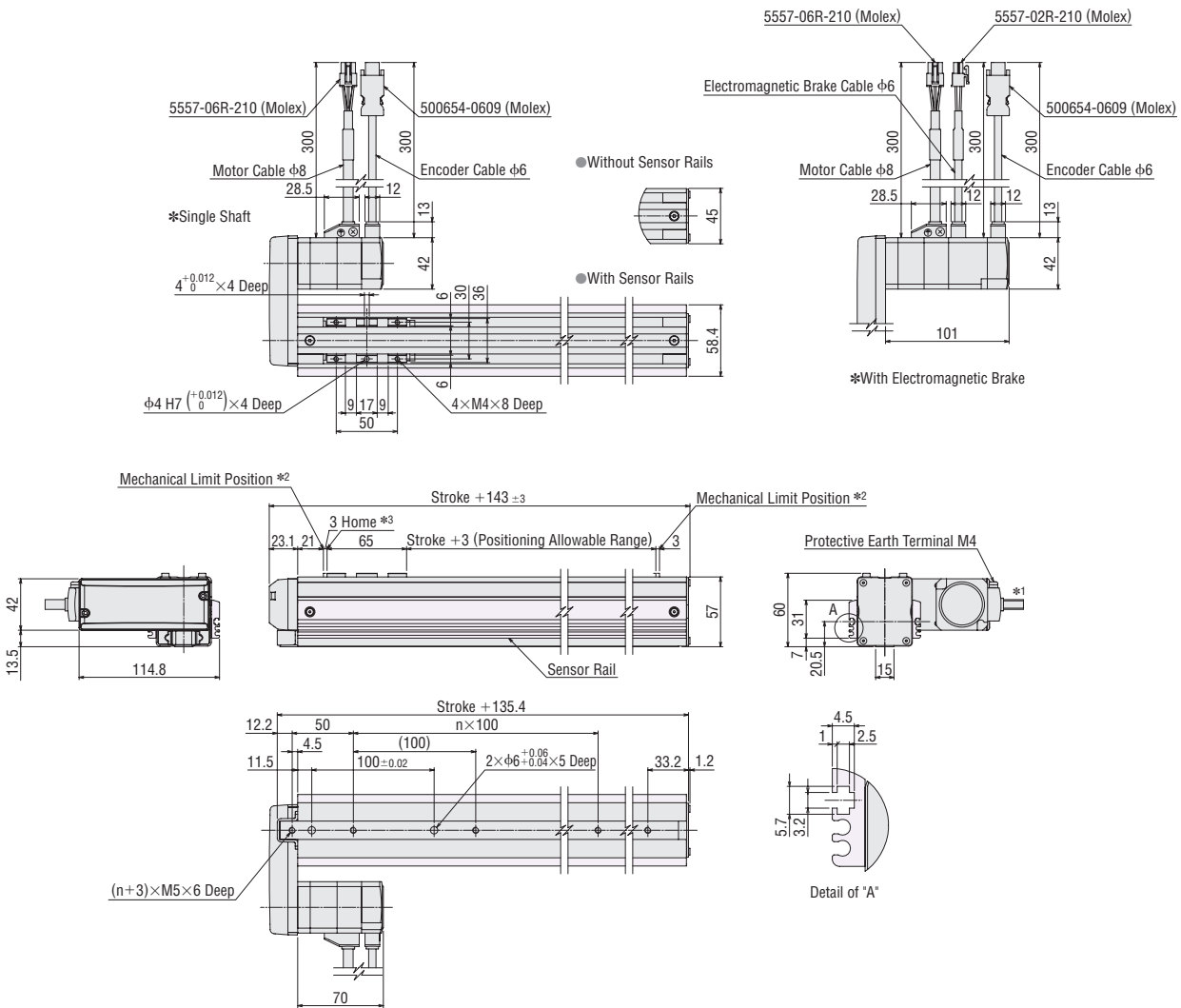

*1 The motor cable outlet direction can be changed in 90° intervals in three directions.

*2 During the pushing return-to-home operation, the table moves to actuator end.

*3 When using an accessory sensor, the home position differs.

● The figure above is for the left reversed motor type. For the right reversed motor type, the motor is located on the opposite side with the slider part center.

Stroke [mm]		50	100	150	200	250	300	350	400	450	500	550	600	650	700	
Hole Coefficient (n)		1	1	2	2	3	3	4	4	5	5	6	6	7	7	
Mass [kg]	With Sensor Rails	Single shaft	1.8	1.9	2.1	2.2	2.4	2.5	2.7	2.9	3.0	3.2	3.4	3.5	3.7	3.8
		With electromagnetic brake	2.0	2.1	2.3	2.4	2.6	2.7	2.9	3.1	3.2	3.4	3.6	3.7	3.9	4.0
	Without Sensor Rails	Single shaft	1.6	1.7	1.9	2.0	2.1	2.2	2.3	2.5	2.6	2.7	2.8	2.9	3.0	3.2
		With electromagnetic brake	1.8	1.9	2.1	2.2	2.3	2.4	2.5	2.7	2.8	2.9	3.0	3.1	3.2	3.4

● **EASM6 Straight Type X-Table With Sensor Rail / Without Sensor Rail**

● Without Sensor Rails

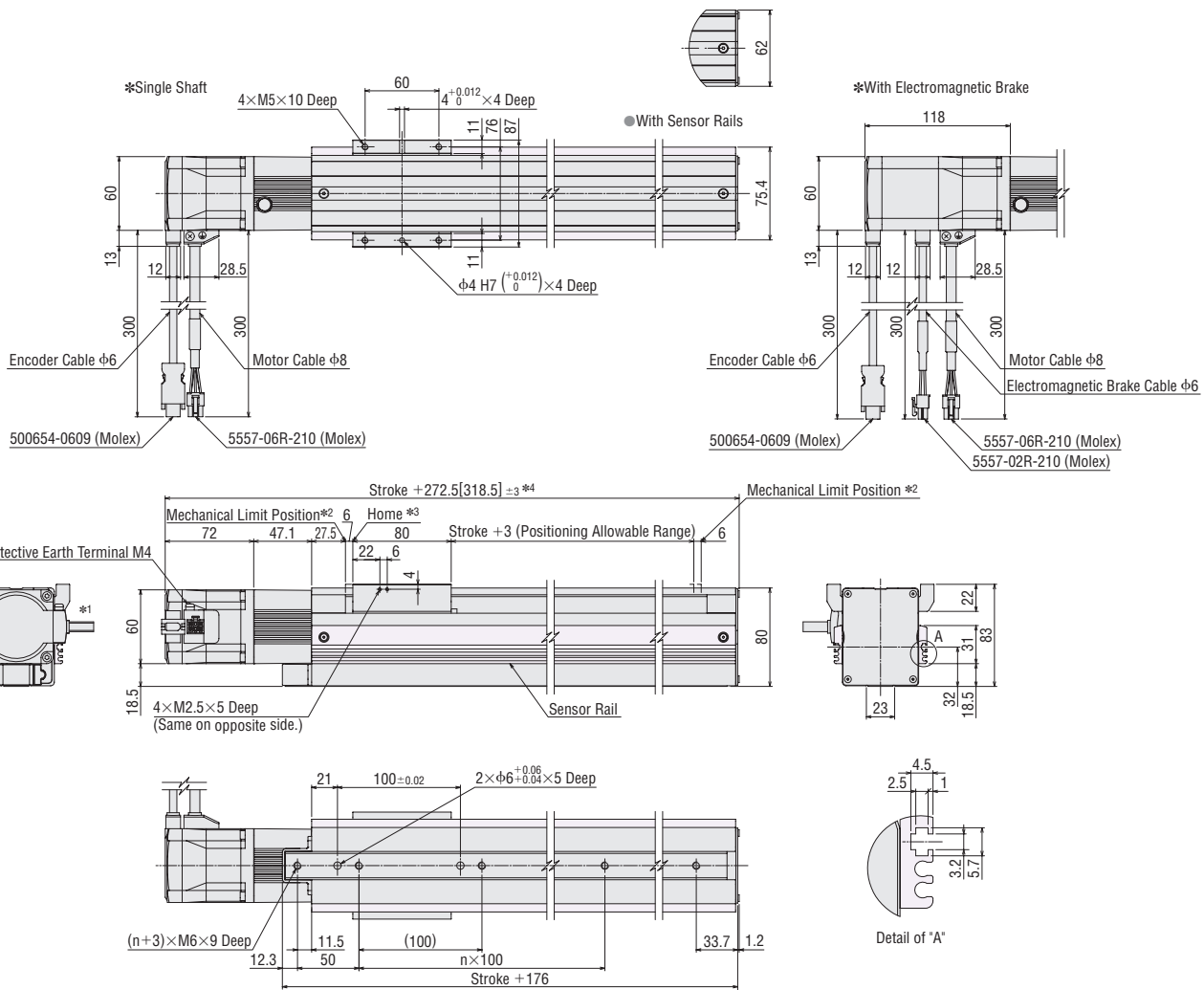

- *1 The motor cable outlet direction can be changed in 90° intervals in four directions.
- *2 During the pushing return-to-home operation, the table moves to actuator end.
- *3 When using an accessory sensor, the home position differs.
- *4 The brackets [] indicate the values for the electromagnetic brake product.

Stroke [mm]		50	100	150	200	250	300	350	400	450	500	550	600	650	700	750	800	850	
Hole Coefficient (n)		1	1	2	2	3	3	4	4	5	5	6	6	7	7	8	8	9	
Mass [kg]	With Sensor Rails	Single shaft	3.9	4.2	4.5	4.8	5.1	5.3	5.6	5.9	6.2	6.5	6.7	7.0	7.3	7.6	7.9	8.1	8.4
		With electromagnetic brake	4.3	4.6	4.9	5.2	5.5	5.7	6.0	6.3	6.6	6.9	7.1	7.4	7.7	8.0	8.3	8.5	8.8
	Without Sensor Rails	Single shaft	3.8	4.0	4.3	4.5	4.7	5.0	5.2	5.5	5.7	6.0	6.2	6.4	6.7	6.9	7.2	7.4	7.6
		With electromagnetic brake	4.2	4.3	4.7	4.9	5.1	5.4	5.6	5.9	6.1	6.4	6.6	6.8	7.1	7.3	7.6	7.8	8.0

Electric Linear Slides

Q-STEP AZ Series Equipped EZS

Q-STEP AZ Series Equipped EAS

Electric Cylinders

Q-STEP AZ Series Equipped EAC

Driver/ Connection cable

Peripheral Equipment

● **EASM6 Reversed Motor Type (Left Side) X-Table With Sensor Rail / Without Sensor Rail**

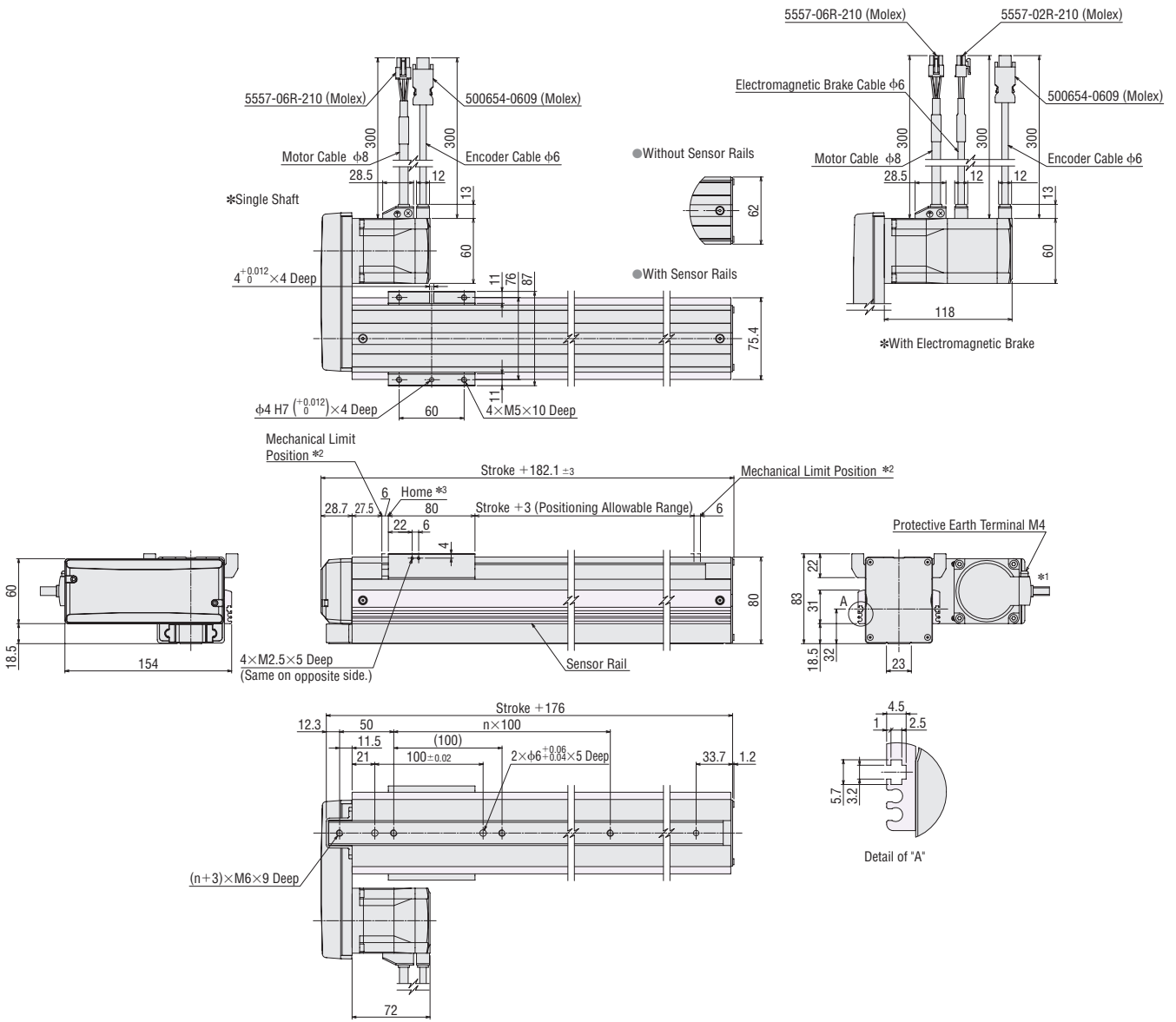

*1 The motor cable outlet direction can be changed in 90° intervals in three directions.

*2 During the pushing return-to-home operation, the table moves to actuator end.

*3 When using an accessory sensor, the home position differs.

● The figure above is for the left reversed motor type. For the right reversed motor type, the motor is located on the opposite side with the slider part center.

Stroke [mm]		50	100	150	200	250	300	350	400	450	500	550	600	650	700	750	800	850	
Hole Coefficient (n)		1	1	2	2	3	3	4	4	5	5	6	6	7	7	8	8	9	
Mass [kg]	With Sensor Rails	Single shaft	3.9	4.2	4.5	4.8	5.1	5.3	5.6	5.9	6.2	6.5	6.7	7.0	7.3	7.6	7.9	8.1	8.4
		With electromagnetic brake	4.3	4.6	4.9	5.2	5.5	5.7	6.0	6.3	6.6	6.9	7.1	7.4	7.7	8.0	8.3	8.5	8.8
	Without Sensor Rails	Single shaft	3.8	4.0	4.3	4.5	4.7	5.0	5.2	5.5	5.7	6.0	6.2	6.4	6.7	6.9	7.2	7.4	7.6
		With electromagnetic brake	4.2	4.3	4.7	4.9	5.1	5.4	5.6	5.9	6.1	6.4	6.6	6.8	7.1	7.3	7.6	7.8	8.0

● **EASM6** Straight Type Y-Table With Sensor Rail / Without Sensor Rail

● Without Sensor Rails

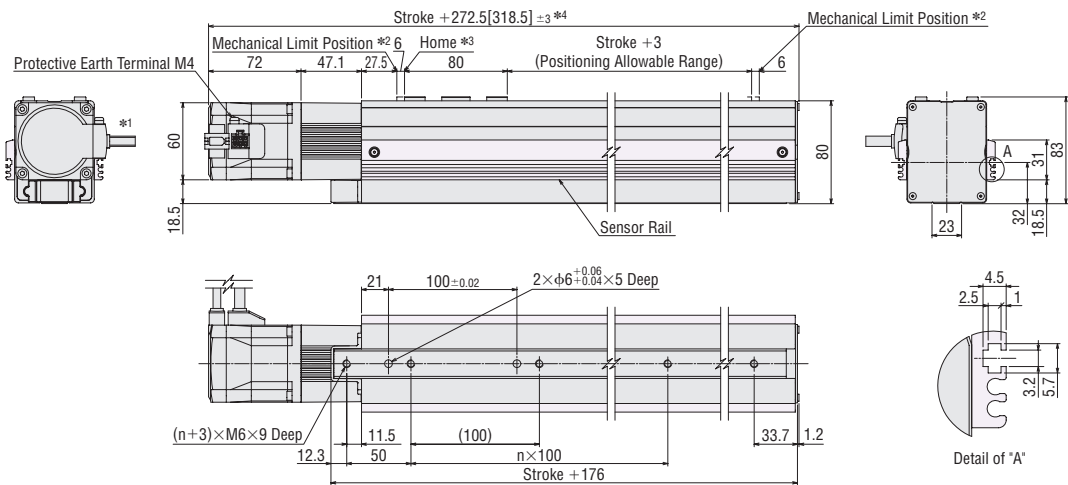
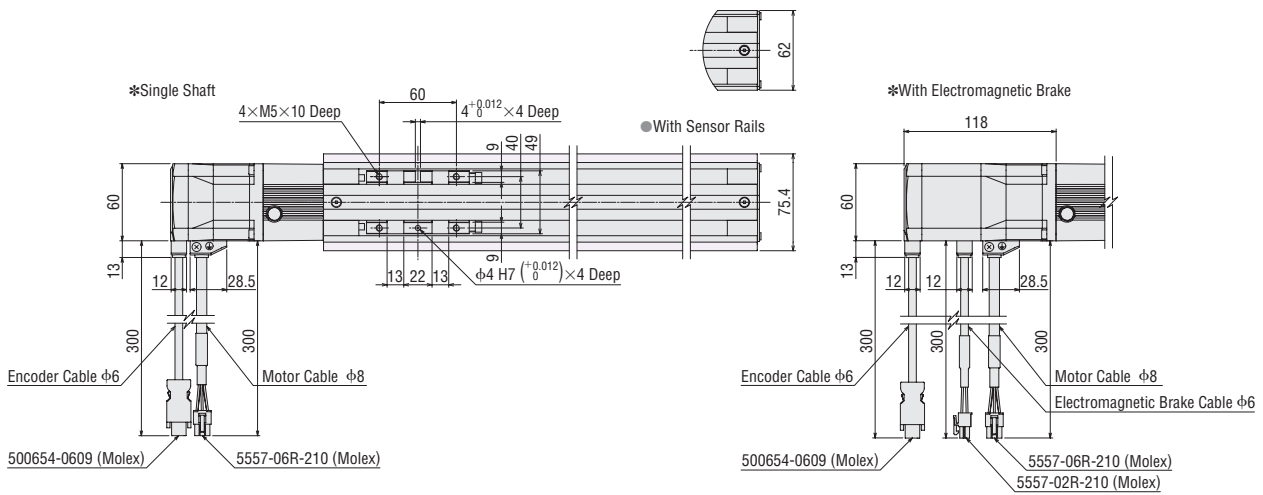

- *1 The motor cable outlet direction can be changed in 90° intervals in four directions.
- *2 During the pushing return-to-home operation, the table moves to actuator end.
- *3 When using an accessory sensor, the home position differs.
- *4 The brackets [] indicate the values for the electromagnetic brake product.

Stroke [mm]		50	100	150	200	250	300	350	400	450	500	550	600	650	700	750	800	850	
Hole Coefficient (n)		1	1	2	2	3	3	4	4	5	5	6	6	7	7	8	8	9	
Mass [kg]	With Sensor Rails	Single shaft	3.9	4.2	4.5	4.8	5.1	5.3	5.6	5.9	6.2	6.5	6.7	7.0	7.3	7.6	7.9	8.1	8.4
		With electromagnetic brake	4.3	4.6	4.9	5.2	5.5	5.7	6.0	6.3	6.6	6.9	7.1	7.4	7.7	8.0	8.3	8.5	8.8
	Without Sensor Rails	Single shaft	3.8	4.0	4.3	4.5	4.7	5.0	5.2	5.5	5.7	6.0	6.2	6.4	6.7	6.9	7.2	7.4	7.6
		With electromagnetic brake	4.2	4.3	4.7	4.9	5.1	5.4	5.6	5.9	6.1	6.4	6.6	6.8	7.1	7.3	7.6	7.8	8.0

Electric Linear Slides

Q-STEP AZ Series Equipped EZS

Q-STEP AZ Series Equipped EAS

Electric Cylinders

Q-STEP AZ Series Equipped EAC

Driver/ Connection cable

Peripheral Equipment

● **EASM6 Reversed Motor Type (Left Side) Y-Table With Sensor Rail / Without Sensor Rail**

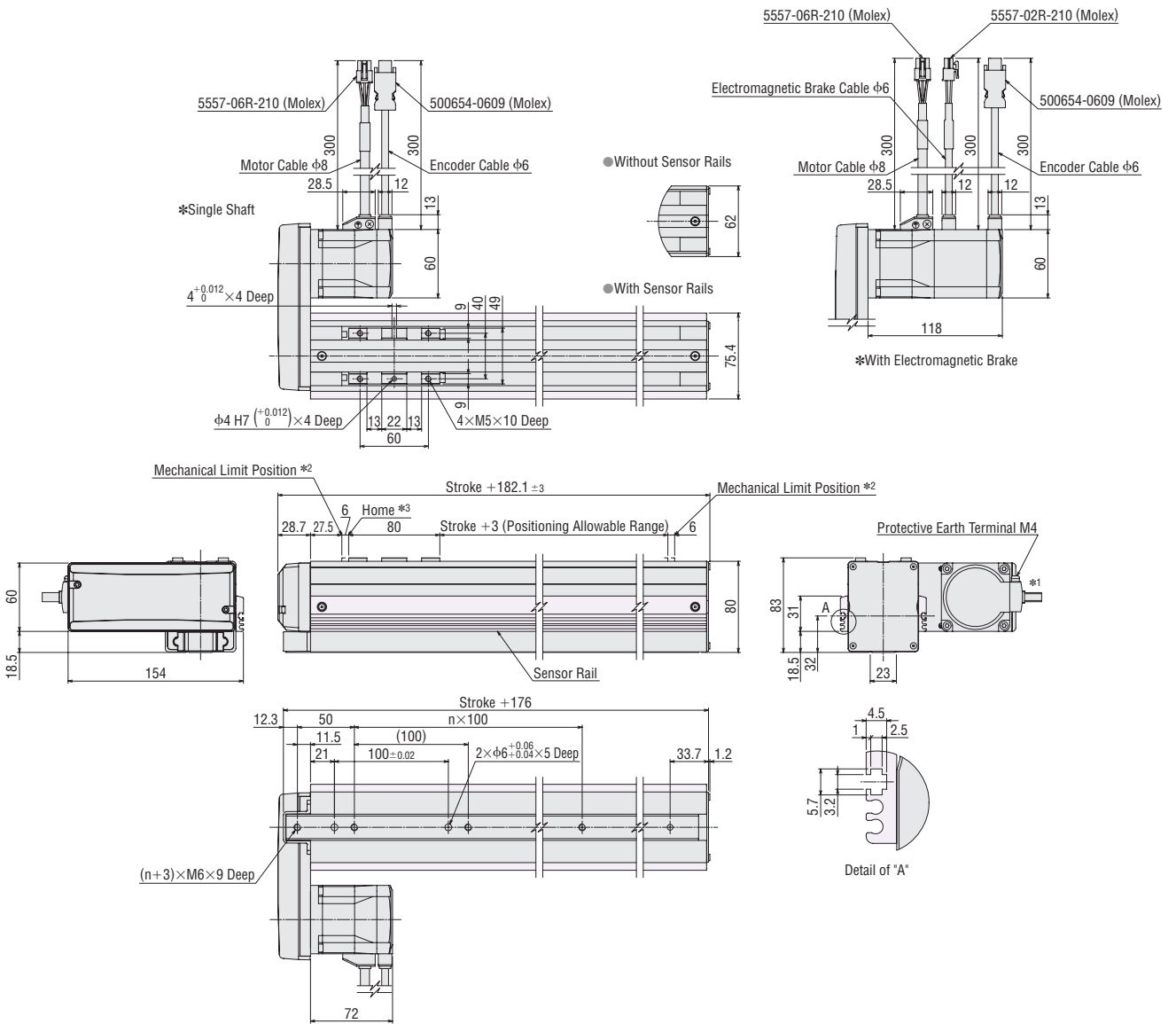

*1 The motor cable outlet direction can be changed in 90° intervals in three directions.

*2 During the pushing return-to-home operation, the table moves to actuator end.

*3 When using an accessory sensor, the home position differs.

● The figure above is for the left reversed motor type. For the right reversed motor type, the motor is located on the opposite side with the slider part center.

Stroke [mm]		50	100	150	200	250	300	350	400	450	500	550	600	650	700	750	800	850	
Hole Coefficient (n)		1	1	2	2	3	3	4	4	5	5	6	6	7	7	8	8	9	
Mass [kg]	With Sensor Rails	Single shaft	3.9	4.2	4.5	4.8	5.1	5.3	5.6	5.9	6.2	6.5	6.7	7.0	7.3	7.6	7.9	8.1	8.4
		With electromagnetic brake	4.3	4.6	4.9	5.2	5.5	5.7	6.0	6.3	6.6	6.9	7.1	7.4	7.7	8.0	8.3	8.5	8.8
	Without Sensor Rails	Single shaft	3.8	4.0	4.3	4.5	4.7	5.0	5.2	5.5	5.7	6.0	6.2	6.4	6.7	6.9	7.2	7.4	7.6
		With electromagnetic brake	4.2	4.3	4.7	4.9	5.1	5.4	5.6	5.9	6.1	6.4	6.6	6.8	7.1	7.3	7.6	7.8	8.0

About Use of the EASM6 (AC Input Type) for Vertical Driving

When operating **EASM6*** type electric linear slides in the vertical direction, depending on the driving conditions, an overvoltage protection alarm may be detected.

In such case, refer to the operating speed-load mass characteristics diagram, and connect the Oriental Motor's **RGB100** regeneration resistor to the driver.

*Common to all AC input specifications of **D** (lead screw pitch 12 mm) / **E** (lead screw pitch 6 mm), Straight / Reversed motor.

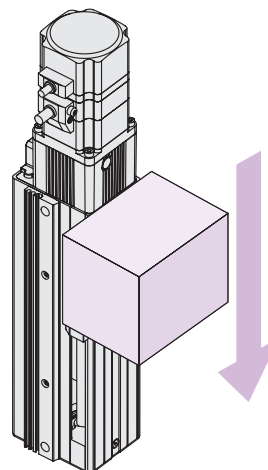

Example of Vertical Use

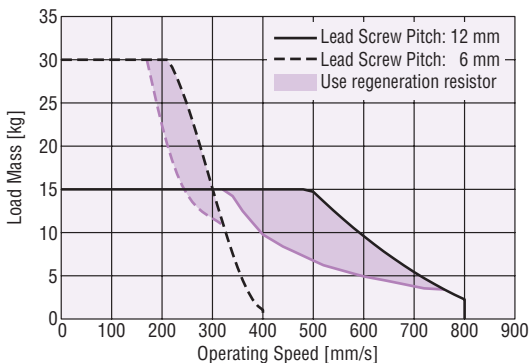

Region in which the regeneration resistor is required for **EASM6** (AC Input Type)

Regeneration Resistor

When a regeneration resistor is connected to the special terminal on the driver, the regenerative power that is fed back from the motor is released as heat energy.



Product Line

Product Name	Applicable Product	List Price
RGB100	AC Input Drivers	45.00 €

Specifications

Item	Specifications
Continuous Regenerative Power	50 W
Resistance Value	150 Ω
Thermostat Operating Temperature	Open: 150±7°C Close: 145±12°C (Normally Closed)
Thermostat Electrical Rating	120 VAC 4 A 30 VDC 4 A (Minimum current 5 mA)

● Install the regeneration resistor in the place which has the same heat radiation capability as heat radiation plate [Material: Aluminum 350 mm×350 mm, 3 mm thick].

Electric Cylinders

EAC Series α STEP AZ Series Equipped

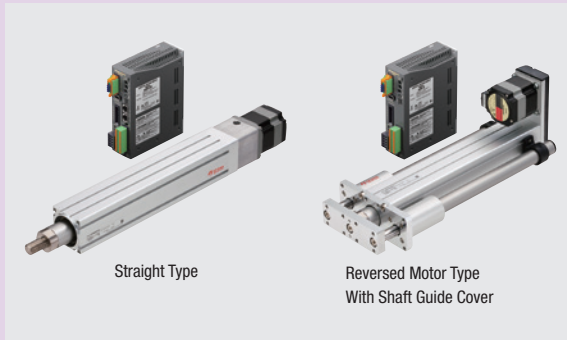

The motor component incorporates a high-efficiency, energy-saving α STEP AZ Series electric cylinder. In addition to straight-type actuators, reversed motor types with shorter overall length that can contribute to space saving are also available.

- Compactness and high thrust force for a wide variety of applications
- High performance regardless of operating conditions
- Easy belt replacement (reversed motor type)

Features

Compactness and High Thrust Force for a Wide Variety of Applications

● Compact and High Thrust Force Cylinders

This series, which uses aluminum for the rod component, is a line of electric cylinders that produces high thrust force despite their compact and lightweight body. The unique structure suppresses vibration to achieve improved acceleration characteristics and high-speed positioning operation.

This illustration shows the straight type without a shaft guide.

Motor

Equipped with the α STEP AZ Series.

- Built-in battery-free absolute sensor
- Positioning information is available without a sensor
- High reliability with closed loop control
- High efficiency technology reduces motor heat generation and saves energy



Built-in Controller Type

Pulse Input Type



Network Compatible

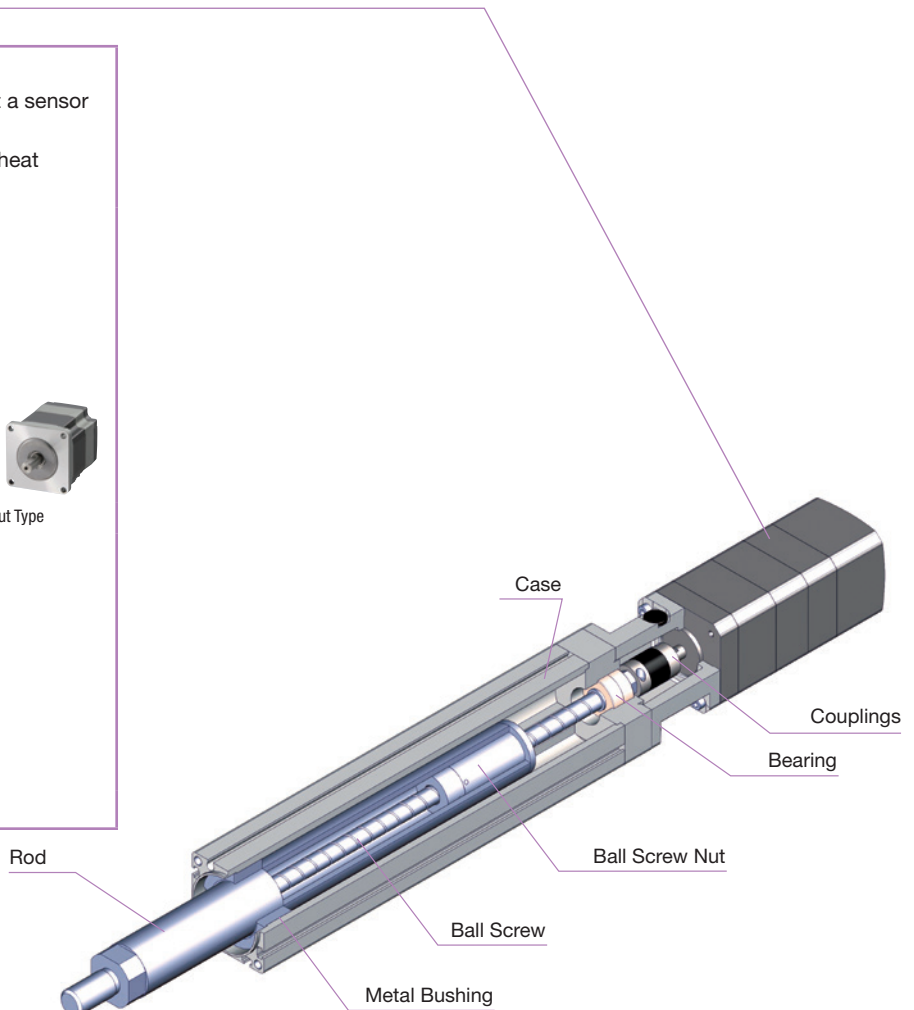

What is FLEX?

FLEX is the collective name for products that support I/O control, Modbus (RTU) control, and FA network control via network converters.

These products enable simple connection and simple control, shortening the total lead time for system construction.

● **Cylinder Type and Configuration**

The **EAC** Series has reversed motor types and straight types. Three types of cylinders are also available: Not equipped with shaft guide, equipped with shaft guide, and equipped with shaft guide cover.

◇ **Reversed Motor Type**

Thanks to the belt mechanism, this type features a reversed motor installation direction.

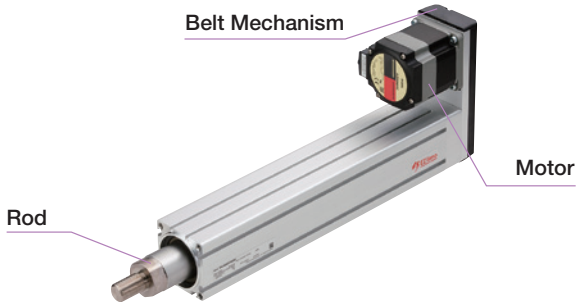

◇ **Equipped with Shaft Guide/Shaft Guide Cover**

This type has a shaft guide and cover installed, which allows for the load to be transported while attached directly to the body of this product. Straight types and reversed motor types are available.

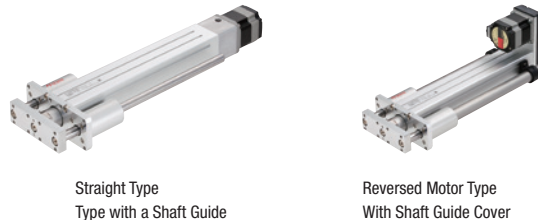

Every model in the product line has a reversed motor type. The shorter overall length contributes to space saving.

EACM4 Type with an Electromagnetic Brake Stroke 200 mm

Straight Type

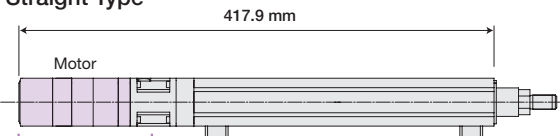

Reversed Motor Type

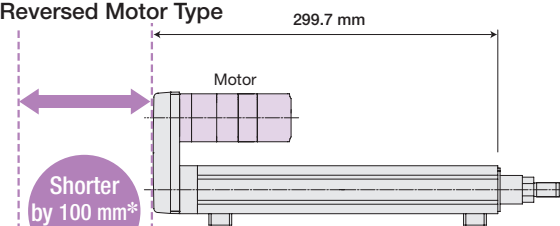

*With Electromagnetic Brake

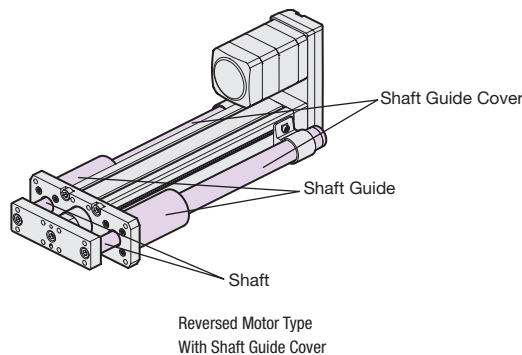

The belt can easily be replaced with Oriental Motor's unique belt tension adjustment mechanism.

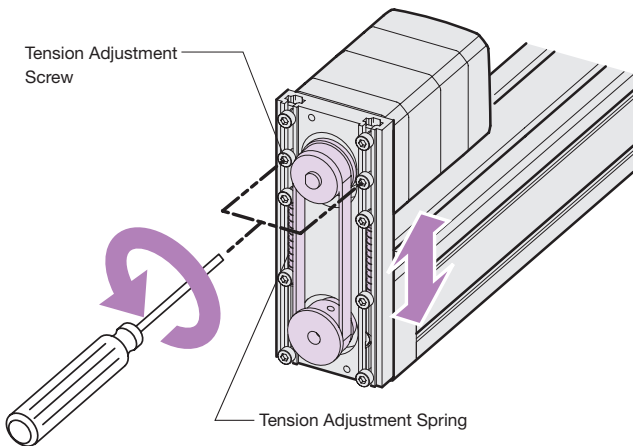

Loosen the screw to adjust the belt to the appropriate tension with spring force.

● **Cable Outlet Direction**

Can be rotated in 4 possible directions (3 for reversed motor type)

The motor cable outlet direction can be freely changed. Because the cable protrudes from the side of the motor, no space behind the motor is needed, further contributing to equipment space saving.

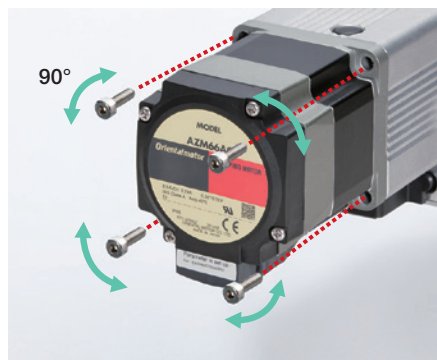

High Performance Regardless of Operating Conditions

● A Wide Range of Applications, from Low Speed to High Speed and from Light Loads to Heavy Loads

High speed driving is possible whether the load is light or heavy.

<Product Used>

Product Name: **EACM6WE**

Lead: 6 mm

Input Type: 200 VAC

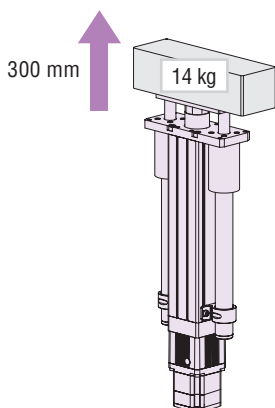

When moving a load mass of 14 kg over a distance of 300 mm, the positioning time is 1.12 seconds.

High Speed Driving Even with a Heavy Load

Load Mass: 14 kg
 Positioning Distance: 300 mm
 Positioning Time: 1.12 s
 Operating Speed: 300 mm/s
 Acceleration: 2.48 m/s² (0.25 G)

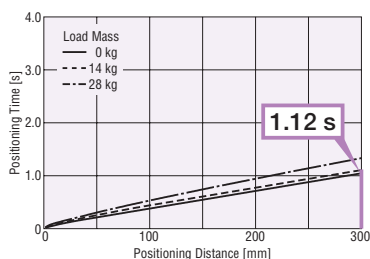

High Speed Driving Even with a Light Load

Load Mass: 0 kg
 Positioning Distance: 300 mm
 Positioning Time: 1.06 s
 Operating Speed: 300 mm/s
 Acceleration: 5.25 m/s² (0.5 G)

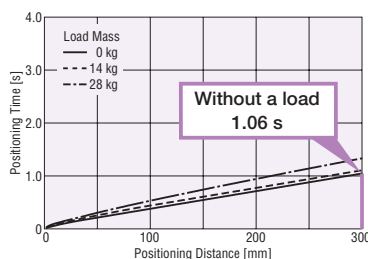



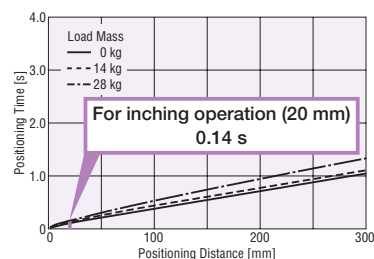

High Speed Driving Even in Inching Operation

Load Mass: 14 kg
 Positioning Distance: 20 mm
 Positioning Time: 0.14 s
 Operating Speed: 200 mm/s
 Acceleration: 5.3 m/s² (0.5 G)

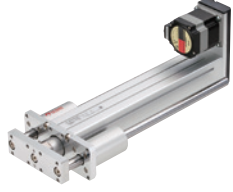

Product Line

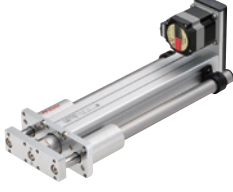
Shaft Guide	Straight Type	Reversed Motor Type
<p>Type without a Shaft Guide</p> <p>An external guide that fits the customer's equipment is required.</p>		
<p>Type with a Shaft Guide</p> <p>Designing an external guide and arranging the components is unnecessary, decreasing the startup time.</p>		
<p>With Shaft Guide Cover</p> <p>The moving part on the cylinder body side is protected, improving equipment safety. This also helps prevent grease from coming off the shaft guide and the intrusion of foreign particles in the linear bushing.</p>		

Electric Linear Slides

QSTEP AZ Series Equipped **EZS**

QSTEP AZ Series Equipped **EAS**

Electric Cylinders

QSTEP AZ Series Equipped **EAC**

Driver/Connection cable





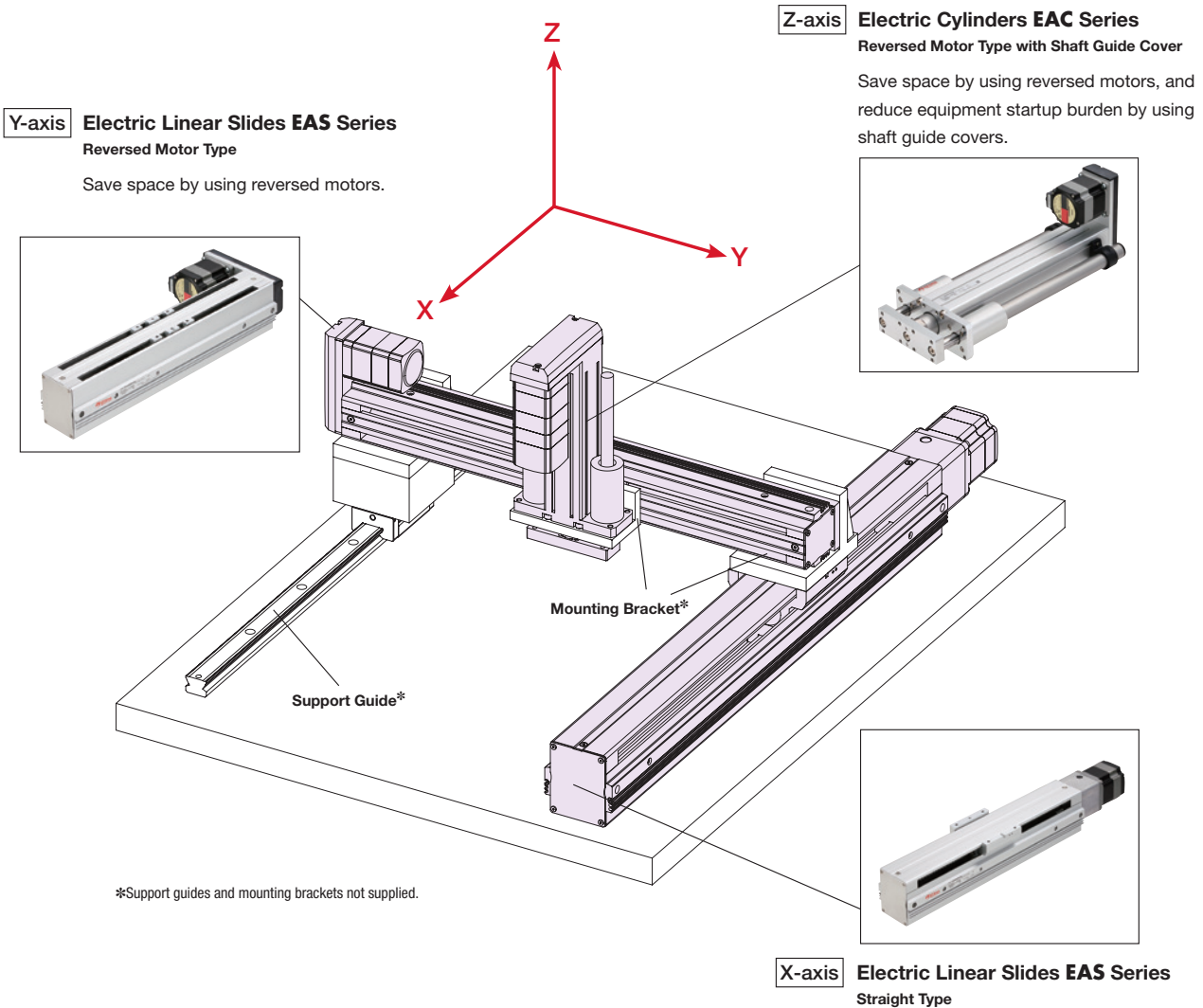















Peripheral Equipment

● Image of 3-axis Equipment Using an **EAC Series** Electric Cylinder on the Z-axis and **EAS Series** Electric Linear Slides on the X- and Y-axes



List of Combinations

















AC Input

Product Line	Series	Product Name (On-board motor name)
Electric Cylinders	EAC Series	EACM4     AZAC-  (AZM46AC) EACM4     AZMC-  (AZM46MC) EACM6     AZAC-  (AZM66AC) EACM6     AZMC-  (AZM66MC)







+

Product Line	Type	Product Name
Driver	Built-in Controller Type	AZD-AD, AZD-CD
	Pulse Input Type with RS-485 Communication	AZD-AX, AZD-CX
	Pulse Input Type	AZD-A, AZD-C
	EtherNet/IP-compatible	AZD-AEP, AZD-CEP
	EtherCAT Drive Profile-compatible	AZD-AED, AZD-CED
	PROFINET-compatible	AZD-APN, AZD-CPN

























+

Product Line	Type	Product Name
Connection Cable Sets/ Flexible Connection Cable Sets	Connection Cable Set	For Motor/Encoder: CC     VZF For Motor/Encoder/Electromagnetic Brake: CC     VZFB
	Flexible Connection Cable Sets	For Motor/Encoder: CC     VZR For Motor/Encoder/Electromagnetic Brake: CC     VZRB

● A number or letter indicating the following is specified where the symbol is located in the product name.

-  Motor installation direction
-  Shaft guide
-  Lead
-  Stroke
-  Shaft guide cover
-  Cable length

























DC Input

Product Line	Series	Product Name (On-board motor name)
Electric Cylinders	EAC Series	EACM2     AZAK (AZM24AK) EACM4     AZAK-  (AZM46AK) EACM4     AZMK-  (AZM46MK) EACM6     AZAK-  (AZM66AK) EACM6     AZMK-  (AZM66MK)







+

Product Line	Type	Product Name
Driver	Built-in Controller Type	AZD-KD
	Pulse Input Type with RS-485 Communication	AZD-KX
	Pulse Input Type	AZD-K
	EtherNet/IP-compatible	AZD-KEP
	EtherCAT Drive Profile-compatible	AZD-KED
	PROFINET-compatible	AZD-KPN

+

Product Line	Type	Product Name	
Connection Cable Sets/ Flexible Connection Cable Sets	For EACM2	Connection Cable Set	CC     VZ2F2
		Flexible Connection Cable Sets	CC     VZ2R2
	For EACM4, EACM6	Connection Cable Set	For Motor/Encoder: CC     VZF2 For Motor/Encoder/Electromagnetic Brake: CC     VZFB2
		Flexible Connection Cable Sets	For Motor/Encoder: CC     VZR2 For Motor/Encoder/Electromagnetic Brake: CC     VZRB2

● A number or letter indicating the following is specified where the symbol is located in the product name.

-  Motor installation direction
-  Shaft guide
-  Lead
-  Stroke
-  Shaft guide cover
-  Cable length

How to Read Specifications

This is how to read specifications, using electric cylinder specifications as an example.

Electric Cylinder Specifications

①	Lead Screw Pitch	mm	12	6		
②	Electromagnetic Brake (Power off activated type)		With	Blank		
③	Drive Method		Ball Screw			
④	Repetitive Positioning Accuracy	mm	±0.02			
⑤	Minimum Traveling Amount	mm	0.01			
⑥	Permissible Moment	Dynamic Permissible Moment	Nm	Mr: 1.3	Mr: 1.3	Mr: 0.6
				Static Permissible Moment	Mr: 3.7	Mr: 3.7
⑦	Transportable Mass	Horizontal	kg	~15	~30	
		Vertical		~6	~13	
⑧	Thrust	N	~70	~140		
⑨	Push Force	N	100	200		
⑩	Holding Force	N	70	140		
⑪	Maximum Speed	mm/s	600	300		

● Depending on the product, there may be usage restrictions or precautions. Refer to the notes on each product's page for details.

① Lead

Distance the rod moves in the linear direction in one motor rotation.

② Electromagnetic Brake (Power off activated type)

There are products with and without a power off activated type electromagnetic brake. Please select the type with an electromagnetic brake when driving in a vertical direction. (Except for **EACM2**)

③ Drive Method

This refers to the mechanism that converts rotation into linear motion.

④ Repetitive Positioning Accuracy

A value indicating the degree of error that generates when positioning is performed repeatedly to the same position in the same direction (measured at a constant temperature and under a constant load).

⑤ Minimum Traveling Amount

The minimum distance that the rod travels. (Factory setting)

⑥ Permissible Moment*

The load moment acts on the linear guide if the load's position is offset from the center of the rod.

The direction of action applies to 3 directions: pitching (MP), yawing (MY), and rolling (MR), depending on the position of the offset. The dynamic permissible moment is the moment during operation. The static permissible moment is the moment while the motor is not moving.

*Specifications for units equipped with shaft guide and shaft guide cover only.

⑦ Transportable Mass

● Horizontal direction

The maximum mass that can be moved under rated operating performance when using the electric cylinder horizontally.

● Vertical direction

The maximum mass that can be moved under rated operating performance when using the electric cylinder vertically.

⑧ Thrust

The thrusting force the rod exerts on the load during constant speed operation.

⑨ Push Force

The pressure at push-motion operation.

⑩ Holding Force

The holding force in power ON state when the motor is stopped and when the electromagnetic brake is activated.

⑪ Maximum Speed

The maximum speed that the maximum transportable mass can be moved.

Product Line of Electric Cylinders

● AC Input

◇ Product Number

① Model	② Motor Orientation	③ Shaft Guide	④ Lead Screw Pitch	⑤ Stroke	⑥ Equipped Motor	⑦ Motor Type	⑧ Motor Specifications	⑨ Shaft Guide Cover
EACM4	R	W	D	05	AZ	A	C	-G
EACM4 EACM6	R: Reversed Motor Type Blank: Straight Type	W: With Shaft Guide Blank: No Shaft Guide	D: 12 mm E: 6 mm	05: 50 mm 10: 100 mm 15: 150 mm ~ 30: 300 mm (50 mm increment)	AZ Series	A: Single Shaft M: With Electromagnetic Brake	C: AC Input Specifications	-G: With Shaft Guide Cover Blank: No Shaft Guide Cover

◇ **EACM4** Straight Type/Reversed Motor Type

The prices are the same even if ② motor orientation (R, Blank), ④ lead screw pitch (D, E) are different.

⑦ Motor Type (A, M)	Single Shaft (A)	With Electromagnetic Brake (M)
⑤ Stroke	50 mm (05)	560.00 €
	100 mm (10)	560.00 €
	150 mm (15)	573.00 €
	200 mm (20)	573.00 €
	250 mm (25)	586.00 €
	300 mm (30)	586.00 €
		749.00 €
		749.00 €
		762.00 €
		762.00 €
		777.00 €
		777.00 €

◇ **EACM4** Straight Type/Reversed Motor Type with Shaft Guide

The prices are the same even if ② motor orientation (R, Blank), ④ lead screw pitch (D, E) are different.

⑦ Motor Type (A, M)	Single Shaft (A)	With Electromagnetic Brake (M)
⑤ Stroke	50 mm (05)	790.00 €
	100 mm (10)	790.00 €
	150 mm (15)	803.00 €
	200 mm (20)	803.00 €
	250 mm (25)	818.00 €
	300 mm (30)	818.00 €
		980.00 €
		980.00 €
		993.00 €
		993.00 €
		1,007.00 €
		1,007.00 €

◇ **EACM4** Straight Type/Reversed Motor Type with Shaft Guide Cover

The prices are the same even if ② motor orientation (R, Blank), ④ lead screw pitch (D, E) are different.

⑦ Motor Type (A, M)	Single Shaft (A)	With Electromagnetic Brake (M)
⑤ Stroke	50 mm (05)	818.00 €
	100 mm (10)	818.00 €
	150 mm (15)	831.00 €
	200 mm (20)	831.00 €
	250 mm (25)	844.00 €
	300 mm (30)	844.00 €
		1,007.00 €
		1,007.00 €
		1,020.00 €
		1,020.00 €
		1,034.00 €
		1,034.00 €

◇ **EACM6** Straight Type/Reversed Motor Type

The prices are the same even if ② motor orientation (R, Blank), ④ lead screw pitch (D, E) are different.

⑦ Motor Type (A, M)	Single Shaft (A)	With Electromagnetic Brake (M)	
⑤ Stroke	50 mm (05)	641.00 €	885.00 €
	100 mm (10)	641.00 €	885.00 €
	150 mm (15)	654.00 €	898.00 €
	200 mm (20)	654.00 €	898.00 €
	250 mm (25)	668.00 €	912.00 €
	300 mm (30)	668.00 €	912.00 €

◇ **EACM6** Straight Type/Reversed Motor Type with Shaft Guide

The prices are the same even if ② motor orientation (R, Blank), ④ lead screw pitch (D, E) are different.

⑦ Motor Type (A, M)	Single Shaft (A)	With Electromagnetic Brake (M)	
⑤ Stroke	50 mm (05)	912.00 €	1,156.00 €
	100 mm (10)	912.00 €	1,156.00 €
	150 mm (15)	926.00 €	1,169.00 €
	200 mm (20)	926.00 €	1,169.00 €
	250 mm (25)	939.00 €	1,184.00 €
	300 mm (30)	939.00 €	1,184.00 €

◇ **EACM6** Straight Type/Reversed Motor Type with Shaft Guide Cover

The prices are the same even if ② motor orientation (R, Blank), ④ lead screw pitch (D, E) are different.

⑦ Motor Type (A, M)	Single Shaft (A)	With Electromagnetic Brake (M)	
⑤ Stroke	50 mm (05)	939.00 €	1,184.00 €
	100 mm (10)	939.00 €	1,184.00 €
	150 mm (15)	953.00 €	1,197.00 €
	200 mm (20)	953.00 €	1,197.00 €
	250 mm (25)	966.00 €	1,210.00 €
	300 mm (30)	966.00 €	1,210.00 €

Electric Linear Slides

QSTEP AZ Series Equipped EZS

QSTEP AZ Series Equipped EAS

Electric Cylinders

QSTEP AZ Series Equipped EAC

Driver/ Connection cable

Peripheral Equipment

● DC Input

◇ Product Number

① Model	② Motor Orientation	③ Shaft Guide	④ Lead Screw Pitch	⑤ Stroke	⑥ Equipped Motor	⑦ Motor Type	⑧ Motor Specifications	⑨ Shaft Guide Cover
EACM4	R	W	D	05	AZ	A	K	-G
EACM2 EACM4 EACM6	R: Reversed Motor Type Blank: Straight Type	W: With Shaft Guide Blank: No Shaft Guide	D: 12 mm E: 6 mm F: 3 mm	05: 50 mm 10: 100 mm 15: 150 mm ~ 30: 300 mm (50 mm increment)	AZ Series	A: Single Shaft M: With Electromagnetic Brake	K: DC Input Specifications*	-G: With Shaft Guide Cover Blank: No Shaft Guide Cover

*For **EACM2** only 24 VDC is applied.

◇ **EACM2** Straight Type

The prices are the same even if ④ Lead Screw Pitch (**E, F**) are different.

⑤ Stroke	50 mm(05)	539.00 €
	100 mm(10)	539.00 €
	150 mm(15)	552.00 €

◇ **EACM2** Straight Type with Shaft Guide Cover

The prices are the same even if ④ Lead Screw Pitch (**E, F**) are different.

⑤ Stroke	50 mm(05)	770.00 €
	100 mm(10)	770.00 €
	150 mm(15)	783.00 €

◇ **EACM4** Straight Type/Reversed Motor Type

The prices are the same even if ② motor orientation (**R, Blank**), ④ lead screw pitch (**D, E**) are different.

⑦ Motor Type (A, M)	Single Shaft (A)	With Electromagnetic Brake (M)
⑤ Stroke	50 mm (05)	560.00 €
	100 mm (10)	560.00 €
	150 mm (15)	573.00 €
	200 mm (20)	573.00 €
	250 mm (25)	586.00 €
	300 mm (30)	586.00 €
		749.00 €
		749.00 €
		762.00 €
		762.00 €
		777.00 €
		777.00 €

◇ **EACM4** Straight Type/Reversed Motor Type with Shaft Guide

The prices are the same even if ② motor orientation (**R, Blank**), ④ lead screw pitch (**D, E**) are different.

⑦ Motor Type (A, M)	Single Shaft (A)	With Electromagnetic Brake (M)
⑤ Stroke	50 mm (05)	790.00 €
	100 mm (10)	790.00 €
	150 mm (15)	803.00 €
	200 mm (20)	803.00 €
	250 mm (25)	818.00 €
	300 mm (30)	818.00 €
		980.00 €
		980.00 €
		993.00 €
		993.00 €
		1,007.00 €
		1,007.00 €

◇ **EACM4** Straight Type/Reversed Motor Type with Shaft Guide Cover

The prices are the same even if ② motor orientation (**R, Blank**), ④ lead screw pitch (**D, E**) are different.

⑦ Motor Type (A, M)	Single Shaft (A)	With Electromagnetic Brake (M)
⑤ Stroke	50 mm (05)	818.00 €
	100 mm (10)	818.00 €
	150 mm (15)	831.00 €
	200 mm (20)	831.00 €
	250 mm (25)	844.00 €
	300 mm (30)	844.00 €
		1,007.00 €
		1,007.00 €
		1,020.00 €
		1,020.00 €
		1,034.00 €
		1,034.00 €

◇ **EACM6** Straight Type/Reversed Motor Type

The prices are the same even if ② motor orientation (R, Blank), ④ lead screw pitch (D, E) are different.

⑦ Motor Type (A, M)	Single Shaft (A)	With Electromagnetic Brake (M)	
⑤ Stroke	50 mm (05)	641.00 €	885.00 €
	100 mm (10)	641.00 €	885.00 €
	150 mm (15)	654.00 €	898.00 €
	200 mm (20)	654.00 €	898.00 €
	250 mm (25)	668.00 €	912.00 €
	300 mm (30)	668.00 €	912.00 €

◇ **EACM6** Straight Type/Reversed Motor Type with Shaft Guide

The prices are the same even if ② motor orientation (R, Blank), ④ lead screw pitch (D, E) are different.

⑦ Motor Type (A, M)	Single Shaft (A)	With Electromagnetic Brake (M)	
⑤ Stroke	50 mm (05)	912.00 €	1,156.00 €
	100 mm (10)	912.00 €	1,156.00 €
	150 mm (15)	926.00 €	1,169.00 €
	200 mm (20)	926.00 €	1,169.00 €
	250 mm (25)	939.00 €	1,184.00 €
	300 mm (30)	939.00 €	1,184.00 €

◇ **EACM6** Straight Type/Reversed Motor Type with Shaft Guide Cover

The prices are the same even if ② motor orientation (R, Blank), ④ lead screw pitch (D, E) are different.

⑦ Motor Type (A, M)	Single Shaft (A)	With Electromagnetic Brake (M)	
⑤ Stroke	50 mm (05)	939.00 €	1,184.00 €
	100 mm (10)	939.00 €	1,184.00 €
	150 mm (15)	953.00 €	1,197.00 €
	200 mm (20)	953.00 €	1,197.00 €
	250 mm (25)	966.00 €	1,210.00 €
	300 mm (30)	966.00 €	1,210.00 €

Included

Type	Included	Operating Manual
Common to All Types		1 Copy

The drivers and cables to be combined with the actuators are the same as the **αSTEP AZ Series**.

αSTEP AZ Series brochure is available.

For selecting the products, refer to the brochure as well.



Electric Linear Slides

αSTEP AZ Series Equipped EZS

αSTEP AZ Series Equipped EAS

Electric Cylinders

αSTEP AZ Series Equipped EAC

Driver/ Connection cable

Peripheral Equipment

System Configuration

- Combination of Electric Cylinder with Electromagnetic Brake and either Built-in Controller Type Driver or Pulse Input Type Driver with RS-485 Communication (Information for AC input type and DC input type are both provided. The photos show the product of AC input type.)

This is an example of a configuration when I/O controlled using a built-in controller type driver or when controlled with RS-485 communication is shown below.

Electric cylinders, drivers, and connection cable sets/flexible connection cable sets need to be ordered separately.

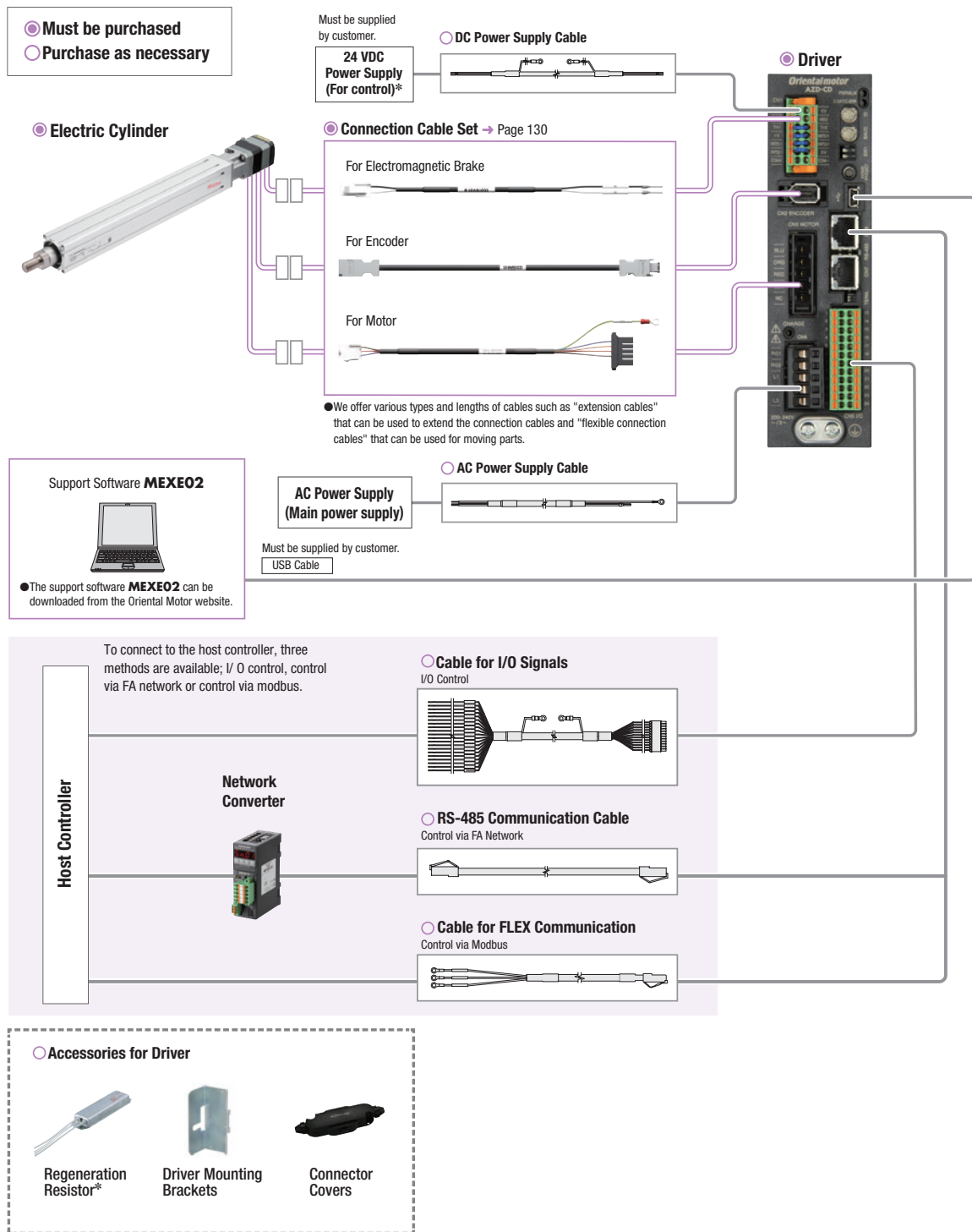

● Example of System Configuration Pricing

<p>Electric Cylinder</p> <p>EACM4D05AZMC</p> <p>749.00 €</p> <p>○</p>	+	<p>Driver</p> <p>AZD-CD</p> <p>528.00 €</p> <p>○</p>	+	<p>Cables</p> <p>Connection Cable Set (1 m)</p> <p>CC010VZFB</p> <p>46.00 €</p> <p>○</p>
--	---	---	---	---

● The system configuration shown above is an example. Other combinations are also available.

Note

● The motor cable and electromagnetic brake cable from the motor cannot be connected directly to the driver. When connecting to a driver, use a connection cable.

● Combination of Electric Cylinder with Electromagnetic Brake and Network-Compatible Driver (Information for AC input type and DC input type are both provided. The photos show the product of AC input type.)

An example of a configuration when I/O controlled using an EtherNet/IP Compatible driver or when controlled with EtherNet/IP is shown below.

Electric cylinders, drivers, and connection cable sets/flexible connection cable sets need to be ordered separately.

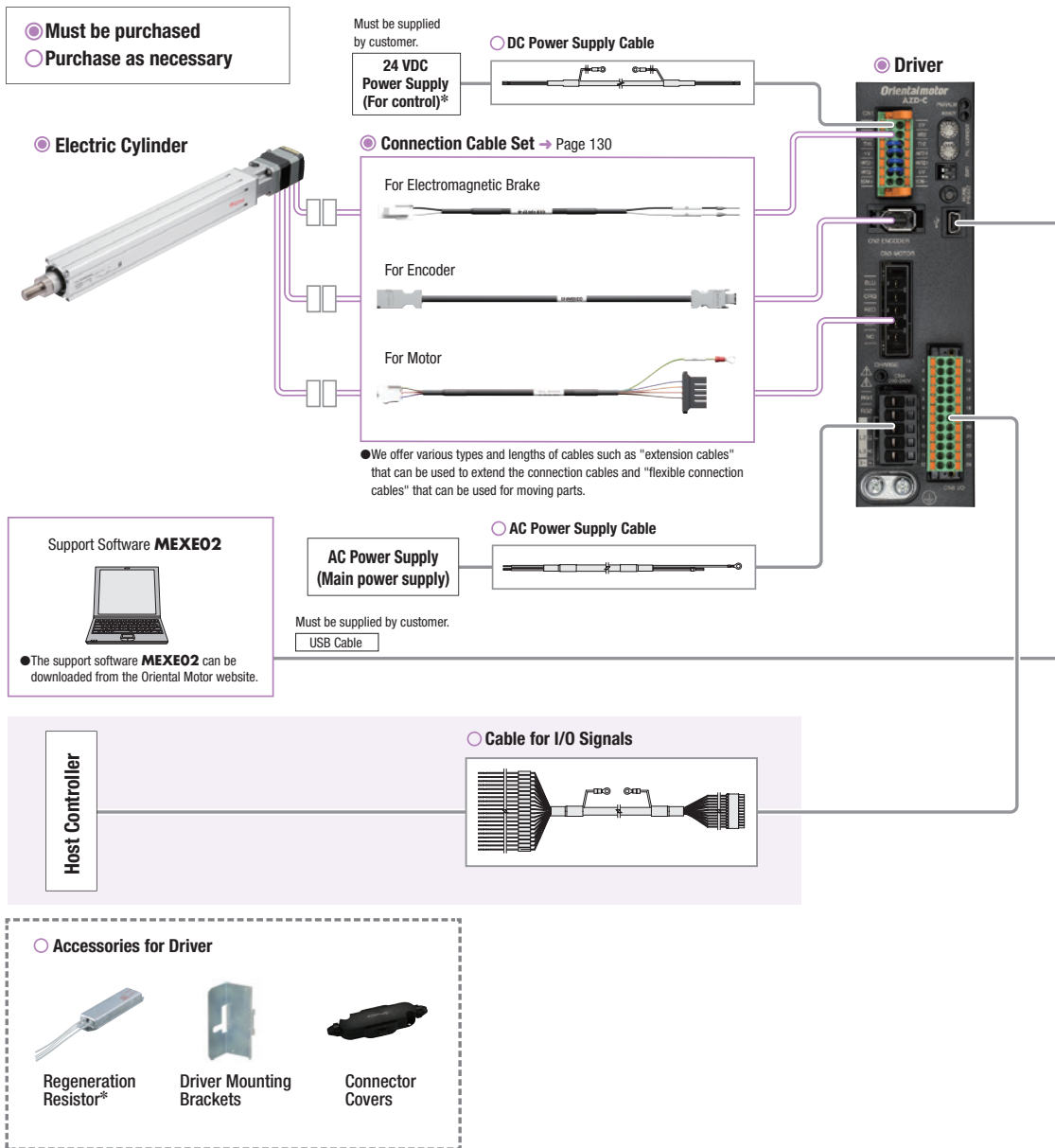

● **Example of System Configuration Pricing**

<table border="1" style="width: 100%; border-collapse: collapse;"> <tr><td style="background-color: #d9ead3;">Electric Cylinder</td></tr> <tr><td style="background-color: #d9ead3;">EACM4D05AZMC</td></tr> <tr><td>749.00 €</td></tr> <tr><td>○</td></tr> </table>	Electric Cylinder	EACM4D05AZMC	749.00 €	○	+	<table border="1" style="width: 100%; border-collapse: collapse;"> <tr><td style="background-color: #d9ead3;">Driver</td></tr> <tr><td style="background-color: #d9ead3;">AZD-C</td></tr> <tr><td>473.00 €</td></tr> <tr><td>○</td></tr> </table>	Driver	AZD-C	473.00 €	○	+	<table border="1" style="width: 100%; border-collapse: collapse;"> <tr><td style="background-color: #d9ead3;">Cables</td></tr> <tr><td style="background-color: #d9ead3;">Connection Cable Set (1 m)</td></tr> <tr><td style="background-color: #d9ead3;">CC010VZFB</td></tr> <tr><td>46.00 €</td></tr> <tr><td>○</td></tr> </table>	Cables	Connection Cable Set (1 m)	CC010VZFB	46.00 €	○
Electric Cylinder																	
EACM4D05AZMC																	
749.00 €																	
○																	
Driver																	
AZD-C																	
473.00 €																	
○																	
Cables																	
Connection Cable Set (1 m)																	
CC010VZFB																	
46.00 €																	
○																	

● The system configuration shown above is an example. Other combinations are also available.

Note

● The motor cable and electromagnetic brake cable from the motor cannot be connected directly to the driver. When connecting to a driver, use a connection cable.

Electric Linear Slides

QSTEP AZ Series Equipped EZS

QSTEP AZ Series Equipped EAS

Electric Cylinders

QSTEP AZ Series Equipped EAC

Driver/ Connection cable

Peripheral Equipment

● Combination of Electric Cylinder with Electromagnetic Brake and Network-Compatible Driver (Information for AC input type and DC input type are both provided. The photos show the product of AC input type.)

An example of a configuration when I/O controlled using an PROFINET Compatible driver or when controlled with PROFINET is shown below.

Electric cylinders, drivers, and connection cable sets/flexible connection cable sets need to be ordered separately.

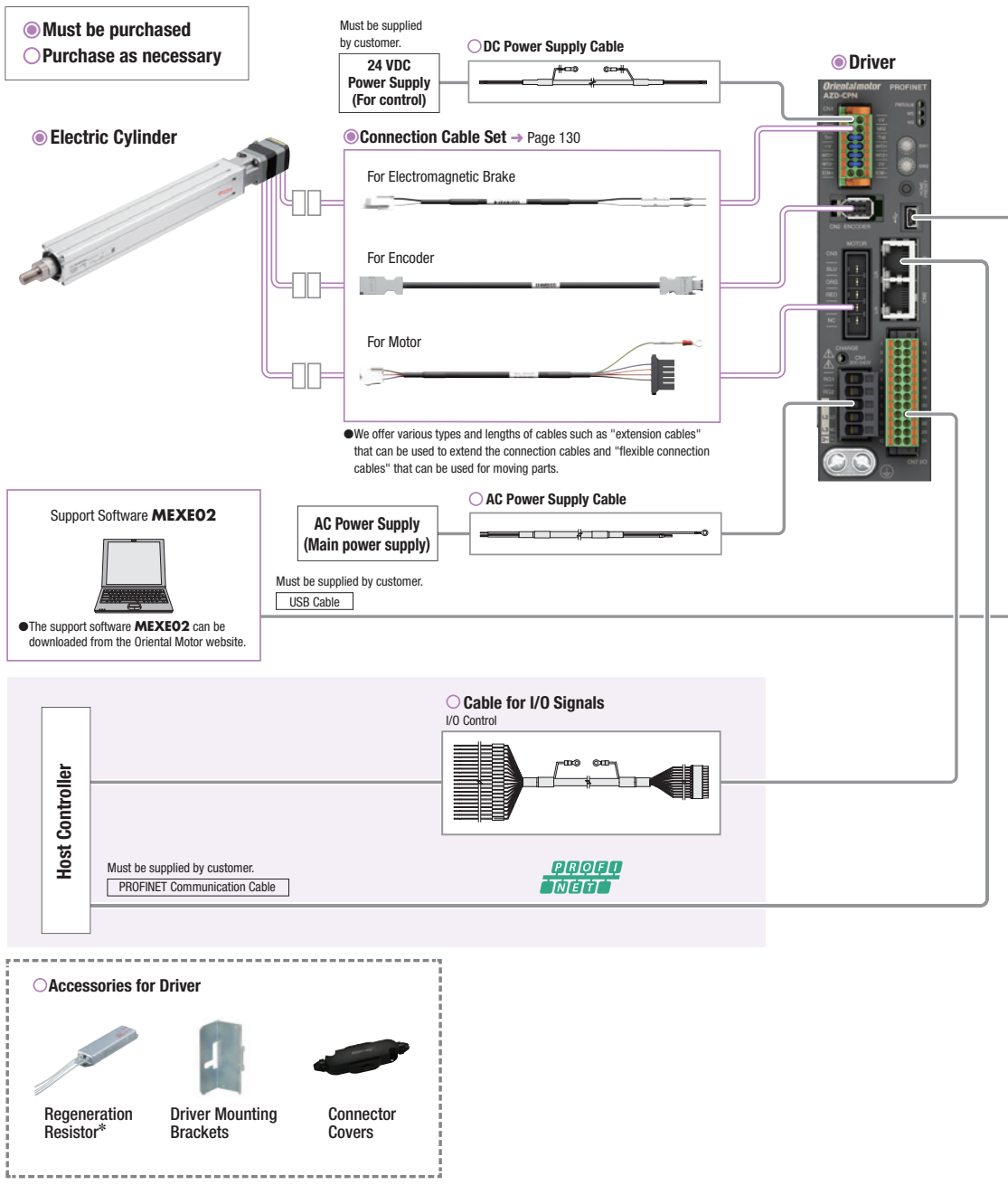

● Example of System Configuration Pricing

Electric Cylinder	+	Driver	+	Cables
EACM4D05AZMC		AZD-CEP		Connection Cable Set (1 m)
749.00 €		572.00 €		CC010VZFB
<input checked="" type="radio"/>		<input checked="" type="radio"/>		<input checked="" type="radio"/>

● The system configuration shown above is an example. Other combinations are also available.

Note

● The motor cable and electromagnetic brake cable from the motor cannot be connected directly to the driver. When connecting to a driver, use a connection cable.

EACM2: Frame Size 28 mm × 28 mm DC Input Straight Type

Electric Linear Slides

QSTEP AZ Series Equipped EZS

QSTEP AZ Series Equipped EAS

Electric Cylinders

QSTEP AZ Series Equipped EAC

Driver/Connection cable

Peripheral Equipment

Product Number

Model	Lead Screw Pitch	Stroke	Equipped Motor	Motor Type	Motor Specifications
EACM2	E	O5	AZ	A	K
EACM2	E : 6 mm F : 3 mm	O5 : 50 mm 10 : 100 mm 15 : 150 mm	AZ Series	A : Single Shaft	K : DC Input Specifications

Electric Cylinder Specifications

Lead Screw Pitch	mm	6	3
Electromagnetic Brake (Power Off Activated Type)		Not equipped	
Drive Method		Ball Screw	
Repetitive Positioning Accuracy	mm	±0.02	
Minimum Travel Amount	mm	0.01	
Permissible Moment	Dynamic Permissible Moment	Nm	Do not apply a radial load or load moment to an electric linear cylinder rod. A simple anti-spin mechanism is already provided, but always be sure to provide an external guide.
	Static Permissible Moment		
Transportable Mass	Horizontal Direction	kg	7.5 Max. 15 Max.
	Vertical Direction	kg	2.5 Max. 5 Max.
Thrust	N	25 Max.	50 Max.
Push Force	N	40	80
Holding Force	N	25	50
Maximum Speed	mm/s	300	150

● Since the holding force is lost when the power is not supplied, the load and external force cannot be held in the vertical direction.

When the product is used for operation in the vertical direction, provide protection external to the equipment.

● The maximum speed may decrease depending on the ambient temperature or the length of the motor cable.

Operating Speed – Thrust

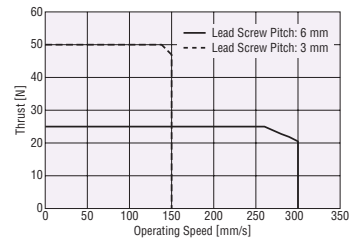

Positioning Distance – Positioning Time

The positioning time (reference) can be checked from the positioning distance.

● Lead Screw Pitch: 6 mm

◇ Horizontal Installation

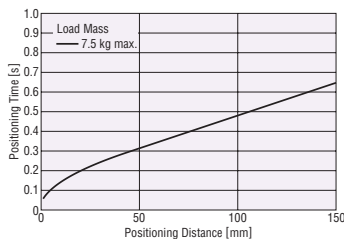

◇ Vertical Installation

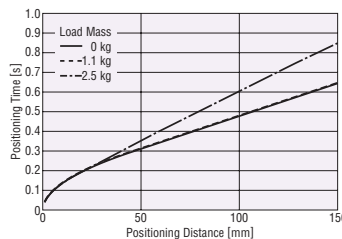

● Lead Screw Pitch: 3 mm

◇ Horizontal Installation

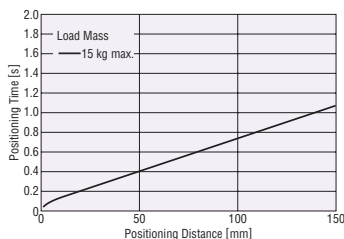

◇ Vertical Installation

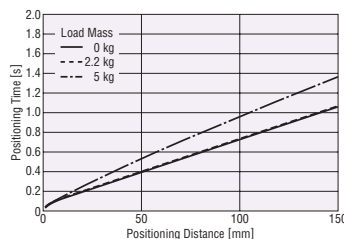

Note

● The starting speed should be 6 mm/s max..

Dimensions

● Electric Cylinders → Page 115

EACM2W: Frame Size 28 mm × 86 mm DC Input Straight Type with Shaft Guide Cover

Product Number

Model	Shaft Guide	Lead Screw Pitch	Stroke	Equipped Motor	Motor Type	Motor Specifications	Shaft Guide Cover
EACM2	W	E	05	AZ	A	K	-G
EACM2	W: With Shaft Guide	E: 6 mm F: 3 mm	05: 50 mm 10: 100 mm 15: 150 mm	AZ Series	A: Single Shaft	K: DC Input Specifications	-G: With Shaft Guide Cover

Electric Cylinder Specifications

Lead Screw Pitch	mm	6	3
Electromagnetic Brake (Power Off Activated Type)		Not equipped	
Drive Method		Ball Screw	
Repetitive Positioning Accuracy	mm	±0.02	
Minimum Travel Amount	mm	0.01	
Permissible Moment	Dynamic Permissible Moment	M _e :0.7 M _r :0.7 M _s :0.3	
	Static Permissible Moment	M _e :1.4 M _r :1.4 M _s :0.6	
Transportable Mass	Horizontal Direction	7.5 Max.	15 Max.
	Vertical Direction	2.0 Max.	4.5 Max.
Thrust	N	25 Max.	50 Max.
Push Force	N	40	80
Holding Force	N	25	50
Maximum Speed	mm/s	300	150

- The transportable mass specifications apply when using external linear guide. When the linear guide is not used, refer to "Horizontal Transportable Mass".
- Since the holding force is lost when the power is not supplied, the load and external force cannot be held in the vertical direction. When the product is used for operation in the vertical direction, provide protection external to the equipment.
- The maximum speed may decrease depending on the ambient temperature or the length of the motor cable.

Positioning Distance – Positioning Time

The positioning time (reference) can be checked from the positioning distance.

Lead Screw Pitch: 6 mm

Horizontal Installation

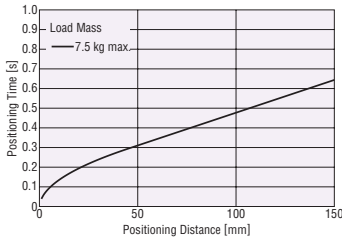

Vertical Installation

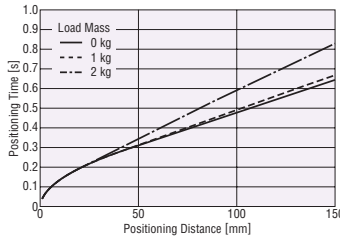

Lead Screw Pitch: 3 mm

Horizontal Installation

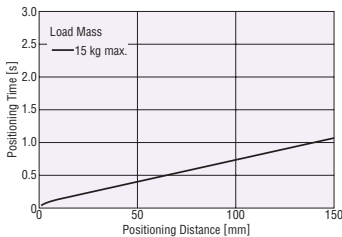

Vertical Installation

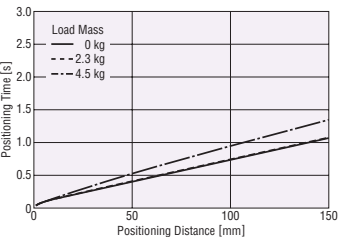

Note

- The starting speed should be 6 mm/s max..

Operating Speed – Thrust

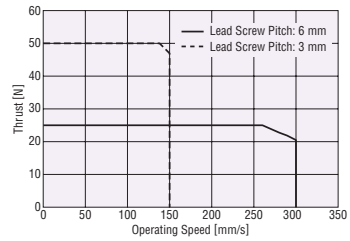

Horizontal Transportable Mass

Positioning Distance – Horizontal Transportable Mass

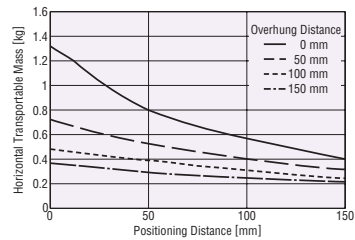

Products equipped with a shaft guide cover can transport loads that are attached directly to the body of the product. Check the horizontal transportable mass in the graph above.

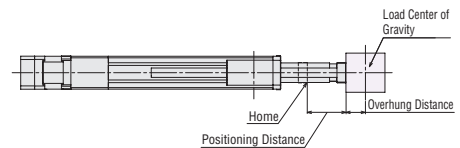

- The positioning distance means the distance from the home position.
- The overhung distance means the distance that the load extends beyond the installation surface.

Dimensions

- Electric Cylinders → Page 120

EACM4: Frame Size 42 mm × 42 mm AC Input Straight Type

Product Number

Model	Lead Screw Pitch	Stroke	Equipped Motor	Motor Type	Motor Specifications
EACM4	D	O5	AZ	A	C
EACM4	D: 12 mm E: 6 mm	O5: 50 mm 10: 100 mm 15: 150 mm ~ 30: 300 mm (50 mm increment)	AZ Series	A: Single Shaft M: With Electromagnetic Brake	C: AC Input Specifications

Electric Cylinder Specifications

Lead Screw Pitch	mm	12	6		
Electromagnetic Brake (Power Off Activated Type)		Equipped	Not equipped	Equipped	Not equipped
Drive Method		Ball Screw			
Repetitive Positioning Accuracy	mm	±0.02			
Minimum Travel Amount	mm	0.01			
Permissible Moment	Dynamic Permissible Moment	Do not apply a radial load or load moment to an electric linear cylinder rod. A simple anti-spin mechanism is already provided, but always be sure to provide an external guide.			
	Static Permissible Moment				
Transportable Mass	Horizontal Direction	15 Max.		30 Max.	
	Vertical Direction	7 Max.	—	14 Max.	—
Thrust	N	70 Max.		140 Max.	
Push Force	N	100		200	
Holding Force	N	70		140	
Maximum Speed	mm/s	600		300	

- The transportable mass specifications apply when using external linear guide.
- Since the holding force is lost when the power is not supplied, the load and external force cannot be held in the vertical direction.
Select a product with an electromagnetic brake for operation in the vertical direction.

Positioning Distance – Positioning Time

The positioning time (reference) can be checked from the positioning distance.

● Lead Screw Pitch: 12 mm

◇ Horizontal Installation



◇ Vertical Installation

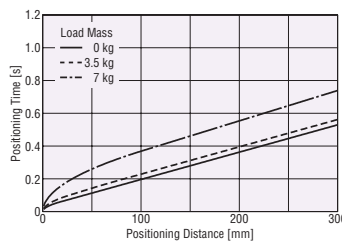

● Lead Screw Pitch: 6 mm

◇ Horizontal Installation

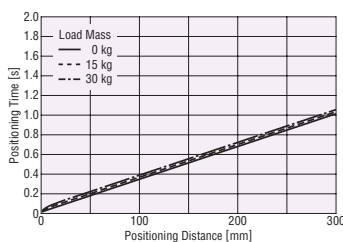

◇ Vertical Installation

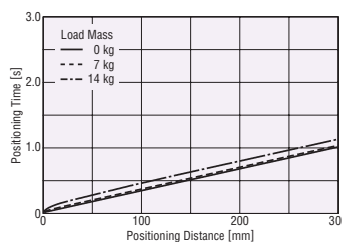

Note:

- The starting speed should be 6 mm/s max..

Operating Speed – Thrust

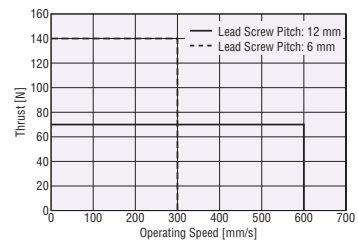

Dimensions

- Electric Cylinders → Page 116

Electric
Linear
Slides

QSTEP
AZ Series
Equipped
EAS

QSTEP
AZ Series
Equipped
EAS

Electric
Cylinders

QSTEP
AZ Series
Equipped
EAC

Driver/
Connection
cable

Peripheral
Equipment

EACM4R: Frame Size 42 mm × 42 mm AC Input Reversed Motor Type

Product Number

Model	Motor Orientation	Lead Screw Pitch	Stroke	Equipped Motor	Motor Type	Motor Specifications
EACM4	R	D	05	AZ	A	C
EACM4	R: Reversed Motor Type	D: 12 mm E: 6 mm	05: 50 mm 10: 100 mm 15: 150 mm ~ 30: 300 mm (50 mm increment)	AZ Series	A: Single Shaft M: With Electromagnetic Brake	C: AC Input Specifications

Electric Cylinder Specifications

Lead Screw Pitch	mm	12	6		
Electromagnetic Brake (Power Off Activated Type)		Equipped	Not equipped	Equipped	Not equipped
Drive Method		Ball Screw			
Repetitive Positioning Accuracy	mm	±0.02			
Minimum Travel Amount	mm	0.01			
Permissible Moment	Dynamic Permissible Moment	Do not apply a radial load or load moment to an electric linear cylinder rod. A simple anti-spin mechanism is already provided, but always be sure to provide an external guide.			
	Static Permissible Moment				
Transportable Mass	Horizontal Direction	15 Max.		30 Max.	
	Vertical Direction	7 Max.	—	12.5 Max.	—
Thrust	N	70 Max.		125 Max.	
Push Force	N	100		200	
Holding Force	N	70		125	
Maximum Speed	mm/s	600		300	

- The transportable mass specifications apply when using external linear guide.
- Since the holding force is lost when the power is not supplied, the load and external force cannot be held in the vertical direction. Select a product with an electromagnetic brake for operation in the vertical direction.

Operating Speed – Thrust

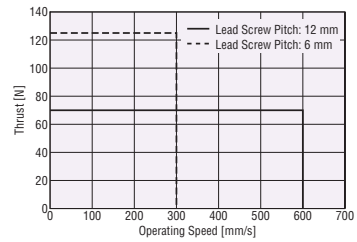

Positioning Distance – Positioning Time

The positioning time (reference) can be checked from the positioning distance.

● Lead Screw Pitch: 12 mm

◇ Horizontal Installation

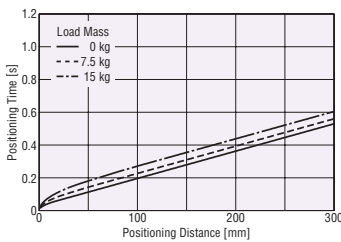

◇ Vertical Installation

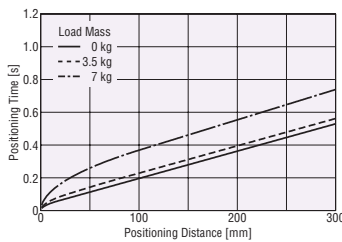

● Lead Screw Pitch: 6 mm

◇ Horizontal Installation

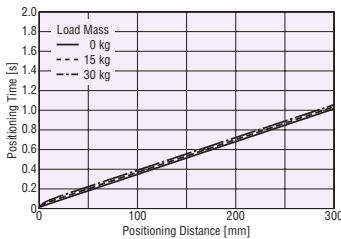

◇ Vertical Installation

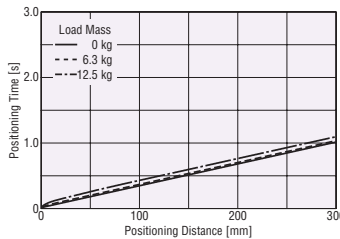

Note

- The starting speed should be 6 mm/s max..

Dimensions

- Electric Cylinders → Page 117

EACM4: Frame Size 42 mm × 42 mm DC Input Straight Type

Product Number

Model	Lead Screw Pitch	Stroke	Equipped Motor	Motor Type	Motor Specifications
EACM4	D	O5	AZ	A	K
EACM4	D: 12 mm E: 6 mm	O5: 50 mm 10: 100 mm 15: 150 mm ~ 30: 300 mm (50 mm increment)	AZ Series	A: Single Shaft M: With Electromagnetic Brake	K: DC Input Specifications

Electric Cylinder Specifications

Lead Screw Pitch	mm	12	6			
Electromagnetic Brake (Power Off Activated Type)		Equipped	Not equipped	Equipped	Not equipped	
Drive Method		Ball Screw				
Repetitive Positioning Accuracy	mm	±0.02				
Minimum Travel Amount	mm	0.01				
Permissible Moment	Dynamic Permissible Moment	Nm	Do not apply a radial load or load moment to an electric linear cylinder rod. A simple anti-spin mechanism is already provided, but always be sure to provide an external guide.			
	Static Permissible Moment					
Transportable Mass	Horizontal Direction	kg	15 Max.	30 Max.		
	Vertical Direction	kg	7 Max.	—	14 Max.	—
Thrust	N		70 Max.	140 Max.		
Push Force	N		100	200		
Holding Force	N		70	140		
Maximum Speed	mm/s		600	300		

- For specifications and characteristics of 48 VDC input products, contact your nearest sales office.
- The transportable mass specifications apply when using external linear guide.
- Since the holding force is lost when the power is not supplied, the load and external force cannot be held in the vertical direction. Select a product with an electromagnetic brake for operation in the vertical direction.
- The maximum speed may decrease depending on the ambient temperature or the length of the motor cable.

Positioning Distance – Positioning Time

The positioning time (reference) can be checked from the positioning distance.

● Lead Screw Pitch: 12 mm

◇ Horizontal Installation

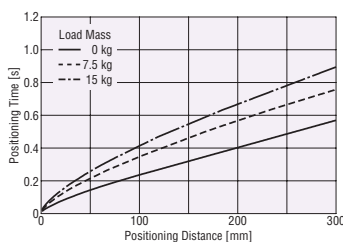

◇ Vertical Installation

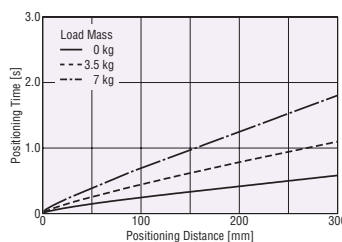

● Lead Screw Pitch: 6 mm

◇ Horizontal Installation

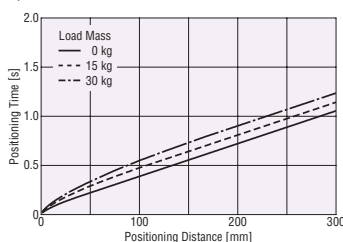

◇ Vertical Installation

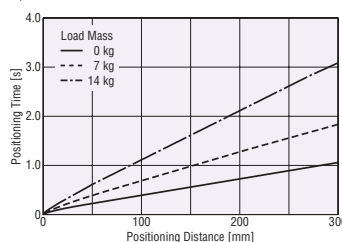

Note

- The starting speed should be 6 mm/s max..

Operating Speed – Thrust

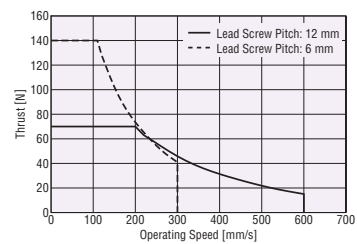

Dimensions

- Electric Cylinders → Page 116

EACM4R: Frame Size 42 mm × 42 mm DC Input Reversed Motor Type

Model	Motor Orientation	Lead Screw Pitch	Stroke	Equipped Motor	Motor Type	Motor Specifications
EACM4	R	D	05	AZ	A	K
EACM4	R: Reversed Motor	D: 12 mm E: 6 mm	05: 50 mm 10: 100 mm 15: 150 mm ~ 30: 300 mm (50 mm increment)	AZ Series	A: Single Shaft M: With Electromagnetic Brake	K: DC Input Specifications

Electric Cylinder Specifications

Lead Screw Pitch		mm	12		6	
Electromagnetic Brake (Power Off Activated Type)			Equipped	Not equipped	Equipped	Not equipped
Drive Method			Ball Screw			
Repetitive Positioning Accuracy		mm	±0.02			
Minimum Travel Amount		mm	0.01			
Permissible Moment	Dynamic Permissible Moment	Nm	Do not apply a radial load or load moment to an electric linear cylinder rod. A simple anti-spin mechanism is already provided, but always be sure to provide an external guide.			
	Static Permissible Moment					
Transportable Mass	Horizontal Direction	kg	15 Max.		30 Max.	
	Vertical Direction		7 Max.	—	12.5 Max.	—
Thrust		N	70 Max.		125 Max.	
Push Force		N	100		200	
Holding Force		N	70		125	
Maximum Speed		mm/s	600		300	

- For specifications and characteristics of 48 VDC input products, contact your nearest sales office.
- The transportable mass specifications apply when using external linear guide.
- Since the holding force is lost when the power is not supplied, the load and external force cannot be held in the vertical direction. Select a product with an electromagnetic brake for operation in the vertical direction.
- The maximum speed may decrease depending on the ambient temperature or the length of the motor cable.

Operating Speed – Thrust

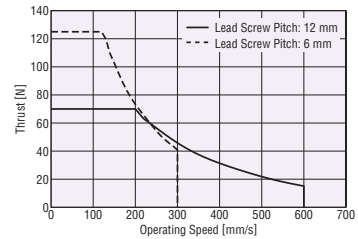

Positioning Distance – Positioning Time

The positioning time (reference) can be checked from the positioning distance.

● Lead Screw Pitch: 12 mm

◇ Horizontal Installation

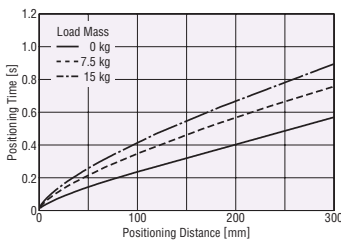

◇ Vertical Installation

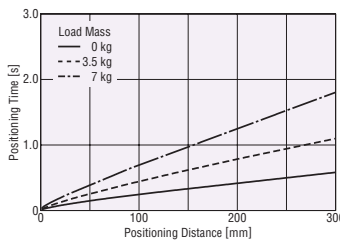

● Lead Screw Pitch: 6 mm

◇ Horizontal Installation

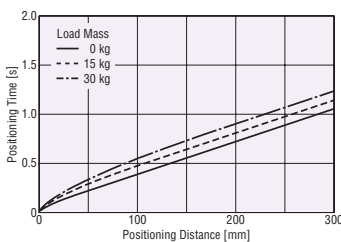

◇ Vertical Installation

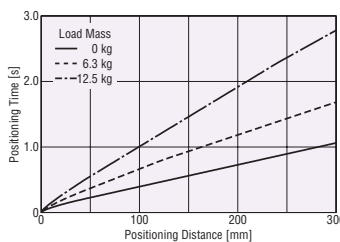

Note

- The starting speed should be 6 mm/s max..

Dimensions

- Electric Cylinders → Page 117

EACM6: Frame Size 60 mm × 60 mm AC Input Straight Type

Model	Lead Screw Pitch	Stroke	Equipped Motor	Motor Type	Motor Specifications
EACM6	D	O5	AZ	A	C
EACM6	D: 12 mm E: 6 mm	O5: 50 mm 10: 100 mm 15: 150 mm ~ 30: 300 mm (50 mm increment)	AZ Series	A: Single Shaft M: With Electromagnetic Brake	C: AC Input Specifications

Electric Cylinder Specifications

Lead Screw Pitch	mm	12	6		
Electromagnetic Brake (Power Off Activated Type)		Equipped	Not equipped	Equipped	Not equipped
Drive Method		Ball Screw			
Repetitive Positioning Accuracy	mm	±0.02			
Minimum Travel Amount	mm	0.01			
Permissible Moment	Dynamic Permissible Moment	Do not apply a radial load or load moment to an electric linear cylinder rod. A simple anti-spin mechanism is already provided, but always be sure to provide an external guide.			
	Static Permissible Moment				
Transportable Mass	Horizontal Direction	~30		~60	
	Vertical Direction	~15	—	~30	—
Thrust	N	~200		~400	
Push Force	N	400		500	
Holding Force	N	200		400	
Maximum Speed	mm/s	600		300	

- The transportable mass specifications apply when using external linear guide.
- Since the holding force is lost when the power is not supplied, the load and external force cannot be held in the vertical direction. Select a product with an electromagnetic brake for operation in the vertical direction.

Positioning Distance – Positioning Time

The positioning time (reference) can be checked from the positioning distance.

● Lead Screw Pitch: 12 mm

◇ Horizontal Installation

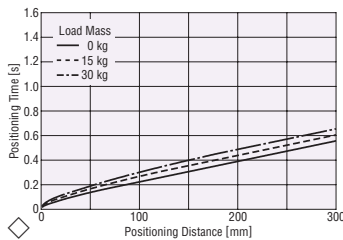

◇ Vertical Installation

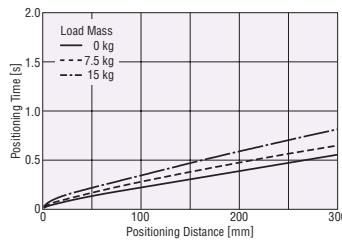

● Lead Screw Pitch: 6 mm

◇ Horizontal Installation

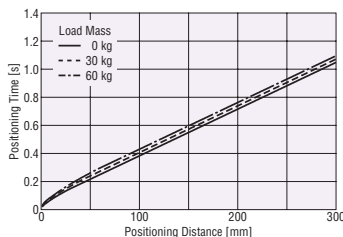

◇ Vertical Installation

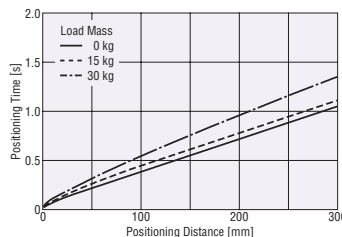

Note

- The starting speed should be 6 mm/s max..

Operating Speed – Thrust

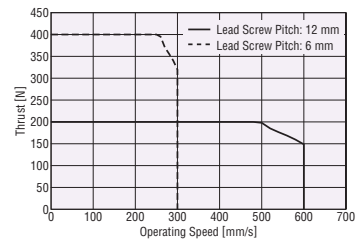

Dimensions

- Electric Cylinders → Page 118

EACM6R: Frame Size 60 mm × 60 mm AC Input Reversed Motor Type

Product Number

Model	Motor Orientation	Lead Screw Pitch	Stroke	Equipped Motor	Motor Type	Motor Specifications
EACM6	R	D	05	AZ	A	C
EACM6	R: Reversed Motor Type	D: 12 mm E: 6 mm	05: 50 mm 10: 100 mm 15: 150 mm ~ 30: 300 mm (50 mm increment)	AZ Series	A: Single Shaft M: With Electromagnetic Brake	C: AC Input Specifications

Electric Cylinder Specifications

Lead Screw Pitch	mm	12	6			
Electromagnetic Brake (Power Off Activated Type)		Equipped	Not equipped	Equipped	Not equipped	
Drive Method		Ball Screw				
Repetitive Positioning Accuracy	mm	±0.02				
Minimum Travel Amount	mm	0.01				
Permissible Moment	Dynamic Permissible Moment	Nm	Do not apply a radial load or load moment to an electric linear cylinder rod. A simple anti-spin mechanism is already provided, but always be sure to provide an external guide.			
	Static Permissible Moment					
Transportable Mass	Horizontal Direction	kg	30 Max.	60 Max.		
	Vertical Direction	kg	15 Max.	—	30 Max.	—
Thrust	N		200 Max.	360 Max.		
Push Force	N		400	500		
Holding Force	N		200	360		
Maximum Speed	mm/s		600	300		

- The transportable mass specifications apply when using external linear guide.
- Since the holding force is lost when the power is not supplied, the load and external force cannot be held in the vertical direction. Select a product with an electromagnetic brake for operation in the vertical direction.

Operating Speed – Thrust

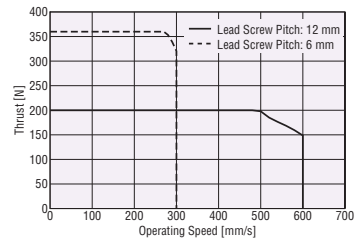

Positioning Distance – Positioning Time

The positioning time (reference) can be checked from the positioning distance.

● Lead Screw Pitch: 12 mm

◇ Horizontal Installation

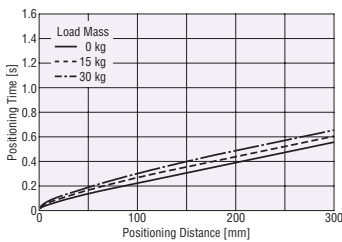

◇ Vertical Installation

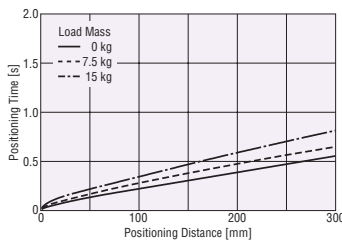

● Lead Screw Pitch: 6 mm

◇ Horizontal Installation

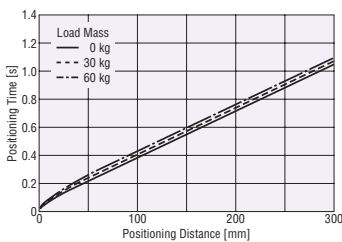

◇ Vertical Installation

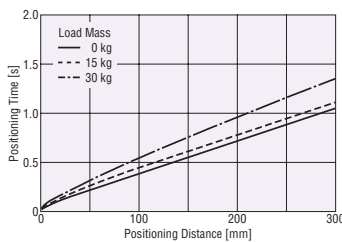

Note

- The starting speed should be 6 mm/s max..

Dimensions

- Electric Cylinders → Page 119

EACM6: Frame Size 60 mm × 60 mm DC Input Straight Type

Model	Lead Screw Pitch	Stroke	Equipped Motor	Motor Type	Motor Specifications
EACM6	D	O5	AZ	A	K
EACM6	D: 12 mm E: 6 mm	O5: 50 mm 10: 100 mm 15: 150 mm ~ 30: 300 mm (50 mm increment)	AZ Series	A: Single Shaft M: With Electromagnetic Brake	K: DC Input Specifications

Electric Cylinder Specifications

Lead Screw Pitch	mm	12	6		
Electromagnetic Brake (Power Off Activated Type)		Equipped	Not equipped	Equipped	Not equipped
Drive Method		Ball Screw			
Repetitive Positioning Accuracy	mm	±0.02			
Minimum Travel Amount	mm	0.01			
Permissible Moment	Dynamic Permissible Moment	Do not apply a radial load or load moment to an electric linear cylinder rod. A simple anti-spin mechanism is already provided, but always be sure to provide an external guide.			
	Static Permissible Moment				
Transportable Mass	Horizontal Direction	~30		~60	
	Vertical Direction	~15	—	~30	—
Thrust	N	~200		~400	
Push Force	N	400		500	
Holding Force	N	200		400	
Maximum Speed	mm/s	600		300	

- For specifications and characteristics of 48 VDC input products, contact your nearest sales office.
- The transportable mass specifications apply when using external linear guide.
- Since the holding force is lost when the power is not supplied, the load and external force cannot be held in the vertical direction. Select a product with an electromagnetic brake for operation in the vertical direction.
- The maximum speed may decrease depending on the ambient temperature or the length of the motor cable.

Positioning Distance – Positioning Time

The positioning time (reference) can be checked from the positioning distance.

● Lead Screw Pitch: 12 mm

◇ Horizontal Installation

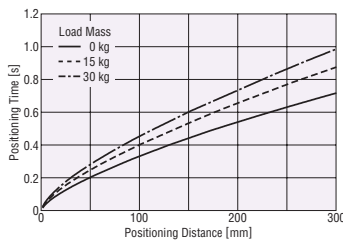

◇ Vertical Installation

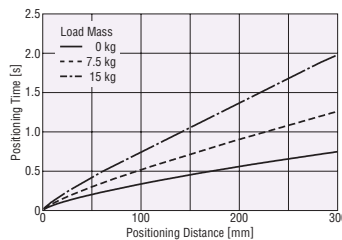

● Lead Screw Pitch: 6 mm

◇ Horizontal Installation

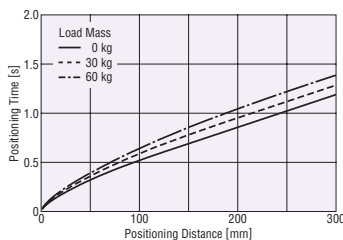

◇ Vertical Installation

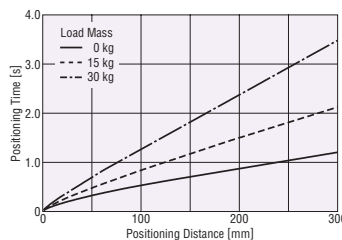

Note

- The starting speed should be 6 mm/s max..

Operating Speed – Thrust

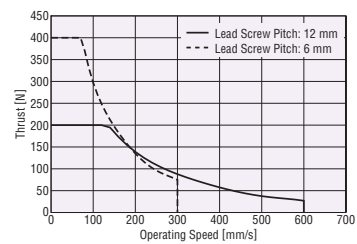

Electric Linear Slides

QSTEP AZ Series Equipped EZS

QSTEP AZ Series Equipped EAS

Electric Cylinders

QSTEP AZ Series Equipped EAC

Driver/ Connection cable

Peripheral Equipment

Dimensions

- Electric Cylinders → Page 118

EACM6R: Frame Size 60 mm × 60 mm DC Input Reversed Motor Type

Product Number

Model	Motor Orientation	Lead Screw Pitch	Stroke	Equipped Motor	Motor Type	Motor Specifications
EACM6	R	D	O5	AZ	A	K
EACM6	R: Reversed Motor Type	D: 12 mm E: 6 mm	O5: 50 mm 10: 100 mm 15: 150 mm ~ 30: 300 mm (50 mm increment)	AZ Series	A: Single Shaft M: With Electromagnetic Brake	K: DC Input Specifications

Electric Cylinder Specifications

Lead Screw Pitch	mm	12	6		
Electromagnetic Brake (Power Off Activated Type)		Equipped	Not equipped	Equipped	Not equipped
Drive Method		Ball Screw			
Repetitive Positioning Accuracy	mm	±0.02			
Minimum Travel Amount	mm	0.01			
Permissible Moment	Dynamic Permissible Moment	Do not apply a radial load or load moment to an electric linear cylinder rod. A simple anti-spin mechanism is already provided, but always be sure to provide an external guide.			
	Static Permissible Moment				
Transportable Mass	Horizontal Direction	30 Max.		60 Max.	
	Vertical Direction	15 Max.	—	30 Max.	—
Thrust	N	200 Max.		360 Max.	
Push Force	N	400		500	
Holding Force	N	200		360	
Maximum Speed	mm/s	600		300	

- For specifications and characteristics of 48 VDC input products, contact your nearest sales office.
- The transportable mass specifications apply when using external linear guide.
- Since the holding force is lost when the power is not supplied, the load and external force cannot be held in the vertical direction. Select a product with an electromagnetic brake for operation in the vertical direction.
- The maximum speed may decrease depending on the ambient temperature or the length of the motor cable.

Operating Speed – Thrust

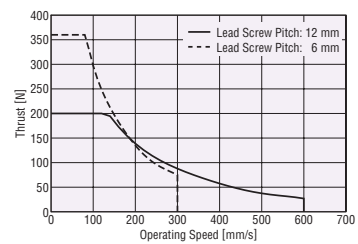

Positioning Distance – Positioning Time

The positioning time (reference) can be checked from the positioning distance.

● Lead Screw Pitch: 12 mm

◇ Horizontal Installation

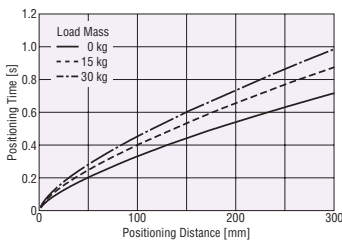

◇ Vertical Installation

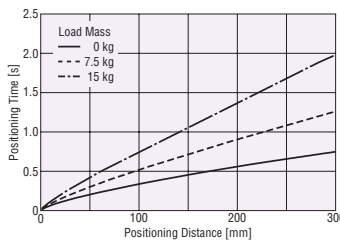

● Lead Screw Pitch: 6 mm

◇ Horizontal Installation

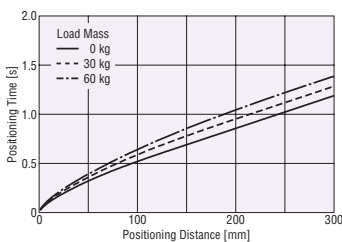

◇ Vertical Installation

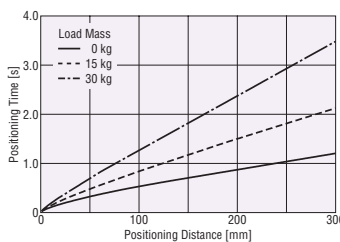

Note

- The starting speed should be 6 mm/s max..

Dimensions

- Electric Cylinders → Page 119

EACM4W: Frame Size 42 mm × 114 mm AC Input Straight Type with Shaft Guide (with Cover)

Product Number

Model	Shaft Guide	Lead Screw Pitch	Stroke	Equipped Motor	Motor Type	Motor Specifications	Shaft Guide Cover
EACM4	W	D	O5	AZ	A	C	-G
EACM4	W: With Shaft Guide	D: 12 mm E: 6 mm	O5: 50 mm 10: 100 mm 15: 150 mm ~ 30: 300 mm (50 mm increment)	AZ Series	A: Single Shaft M: With Electromagnetic Brake	C: AC Input Specifications	-G: With Shaft Guide Cover Blank: No Shaft Guide Cover

Electric Cylinder Specifications

Lead Screw Pitch	mm	12	6		
Electromagnetic Brake (Power Off Activated Type)		Equipped	Not equipped	Equipped	Not equipped
Drive Method		Ball Screw			
Repetitive Positioning Accuracy	mm	±0.02			
Minimum Travel Amount	mm	0.01			
Permissible Moment	Dynamic Permissible Moment	M _r :1.3 M _v :1.3 M _s :0.6			
	Static Permissible Moment	M _r :3.7 M _v :3.7 M _s :3.0			
Transportable Mass	Horizontal Direction	15 Max.		30 Max.	
	Vertical Direction	6 Max.	—	13 Max.	—
Thrust	N	70 Max.		140 Max.	
Push Force	N	100		200	
Holding Force	N	70		140	
Maximum Speed	mm/s	600		300	

- The transportable mass specifications apply when using external linear guide. When the linear guide is not used, refer to "Horizontal Transportable Mass".
- Since the holding force is lost when the power is not supplied, the load and external force cannot be held in the vertical direction. Select a product with an electromagnetic brake for operation in the vertical direction.

Positioning Distance – Positioning Time

The positioning time (reference) can be checked from the positioning distance.

● Lead Screw Pitch: 12 mm

◇ Horizontal Installation



◇ Vertical Installation

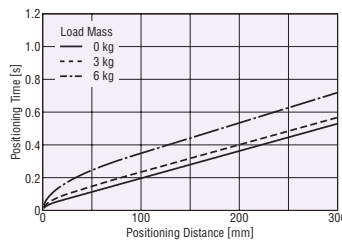

● Lead Screw Pitch: 6 mm

◇ Horizontal Installation

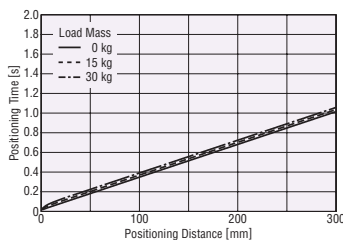

◇ Vertical Installation

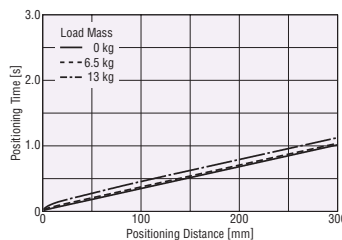

Note

- The starting speed should be 6 mm/s max..

Operating Speed – Thrust

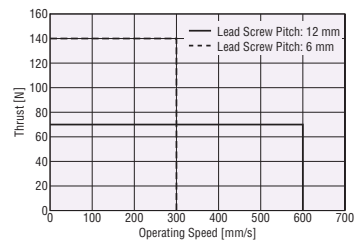

Horizontal Transportable Mass

◇ Positioning Distance – Horizontal Transportable Mass

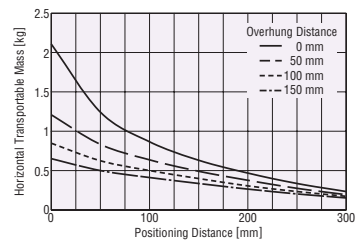

Products equipped with a shaft guide and shaft guide cover can transport loads that are attached directly to the body of the product. Check the horizontal transportable mass in the graph above.

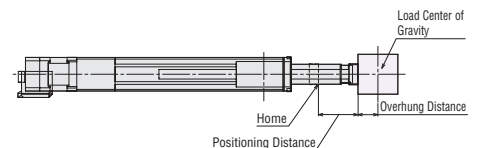

- The positioning distance means the distance from the home position.
- The overhung distance means the distance that the load extends beyond the installation surface.

Dimensions

- Electric Cylinders → Page 121

EACM4RW: Frame Size 42 mm × 114 mm AC Input Reversed Motor Type with Shaft Guide (with Cover)

Product Number

Model	Motor Orientation	Shaft Guide	Lead Screw Pitch	Stroke	Equipped Motor	Motor Type	Motor Specifications	Shaft Guide Cover
EACM4	R	W	D	05	AZ	A	C	-G
EACM4	R: Reversed Motor Type	W: With Shaft Guide	D: 12 mm E: 6 mm	05: 50 mm 10: 100 mm 15: 150 mm ~ 30: 300 mm (50 mm increment)	AZ Series	A: Single Shaft M: With Electromagnetic Brake	C: AC Input Specifications	-G: With Shaft Guide Cover Blank: No Shaft Guide Cover

Electric Cylinder Specifications

Lead Screw Pitch	mm	12	6		
Electromagnetic Brake (Power Off Activated Type)		Equipped	Not equipped	Equipped	Not equipped
Drive Method		Ball Screw			
Repetitive Positioning Accuracy	mm	±0.02			
Minimum Travel Amount	mm	0.01			
Permissible Moment	Dynamic Permissible Moment	M _r :1.3 M _v :1.3 M _s :0.6			
	Static Permissible Moment	M _r :3.7 M _v :3.7 M _s :3.0			
Transportable Mass	Horizontal Direction	15 Max.		30 Max.	
	Vertical Direction	6 Max.	—	11.5 Max.	—
Thrust	N	70 Max.		125 Max.	
Push Force	N	100		200	
Holding Force	N	70		125	
Maximum Speed	mm/s	600		300	

- The transportable mass specifications apply when using external linear guide. When the linear guide is not used, refer to "Horizontal Transportable Mass".
- Since the holding force is lost when the power is not supplied, the load and external force cannot be held in the vertical direction. Select a product with an electromagnetic brake for operation in the vertical direction.

Positioning Distance – Positioning Time

The positioning time (reference) can be checked from the positioning distance.

● Lead Screw Pitch: 12 mm

◇ Horizontal Installation

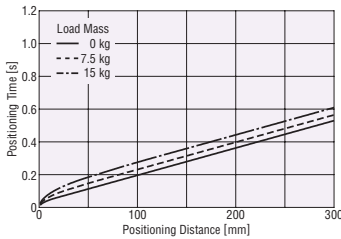

◇ Vertical Installation

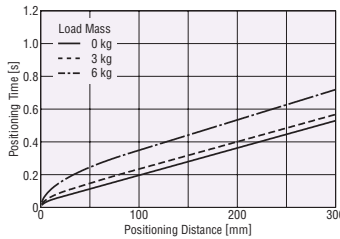

● Lead Screw Pitch: 6 mm

◇ Horizontal Installation

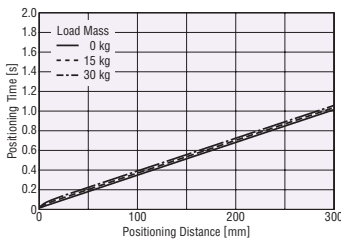

◇ Vertical Installation

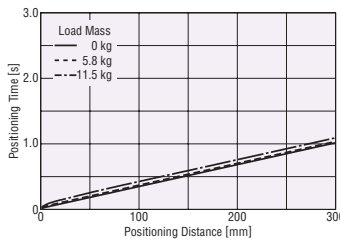

Note

- The starting speed should be 6 mm/s max..

Operating Speed – Thrust

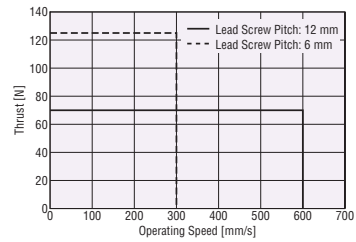

Horizontal Transportable Mass

◇ Positioning Distance – Horizontal Transportable Mass

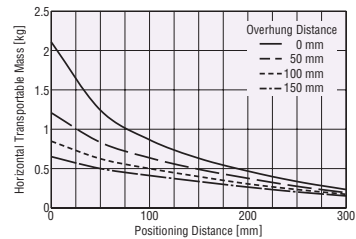

Products equipped with a shaft guide and shaft guide cover can transport loads that are attached directly to the body of the product. Check the horizontal transportable mass in the graph above.

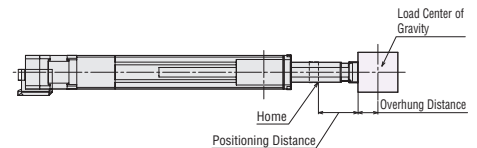

- The positioning distance means the distance from the home position.
- The overhung distance means the distance that the load extends beyond the installation surface.

Dimensions

- Electric Cylinders → Page 122

EACM4W: Frame Size 42 mm × 114 mm DC Input Straight Type with Shaft Guide (with Cover)

Electric
Linear
Slides

QSTEP
AZ Series
Equipped
E2S

QSTEP
AZ Series
Equipped
EAS

Electric
Cylinders

QSTEP
AZ Series
Equipped
EAC

Driver/
Connection
cable

Peripheral
Equipment

Product Number

Model	Shaft Guide	Lead Screw Pitch	Stroke	Equipped Motor	Motor Type	Motor Specifications	Shaft Guide Cover
EACM4	W	D	05	AZ	A	K	-G
EACM4	W: With Shaft Guide	D: 12 mm E: 6 mm	05: 50 mm 10: 100 mm 15: 150 mm ~ 30: 300 mm (50 mm increment)	AZ Series	A: Single Shaft M: With Electromagnetic Brake	K: DC Input Specifications	-G: With Shaft Guide Cover Blank: No Shaft Guide Cover

Electric Cylinder Specifications

Lead Screw Pitch	mm	12	6		
Electromagnetic Brake (Power Off Activated Type)		Equipped	Not equipped	Equipped	Not equipped
Drive Method		Ball Screw			
Repetitive Positioning Accuracy	mm	±0.02			
Minimum Travel Amount	mm	0.01			
Permissible Moment	Dynamic Permissible Moment	M _r :1.3 M _v :1.3 M _s :0.6			
	Static Permissible Moment	M _r :3.7 M _v :3.7 M _s :3.0			
Transportable Mass	Horizontal Direction	15 Max.		30 Max.	
	Vertical Direction	6 Max.	—	13 Max.	—
Thrust	N	70 Max.		140 Max.	
Push Force	N	100		200	
Holding Force	N	70		140	
Maximum Speed	mm/s	600		300	

- For specifications and characteristics of 48 VDC input products, contact your nearest sales office.
- The transportable mass specifications apply when using external linear guide.
When the linear guide is not used, refer to "Horizontal Transportable Mass".
- Since the holding force is lost when the power is not supplied, the load and external force cannot be held in the vertical direction. Select a product with an electromagnetic brake for operation in the vertical direction.
- The maximum speed may decrease depending on the ambient temperature or the length of the motor cable.

Positioning Distance – Positioning Time

The positioning time (reference) can be checked from the positioning distance.

Lead Screw Pitch: 12 mm

Horizontal Installation

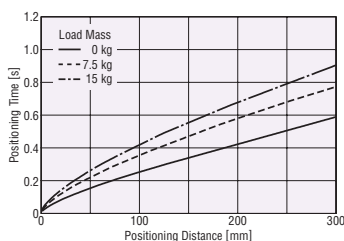

Vertical Installation

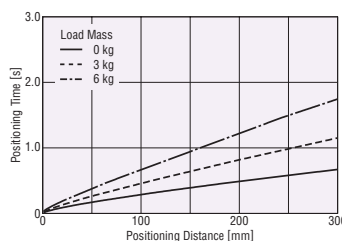

Lead Screw Pitch: 6 mm

Horizontal Installation



Vertical Installation

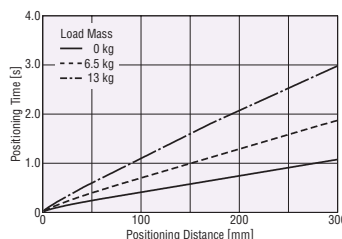

Note

- The starting speed should be 6 mm/s max..

Operating Speed – Thrust

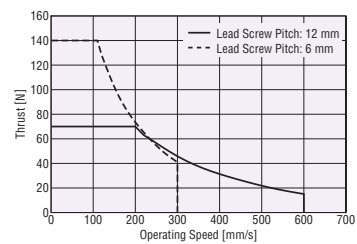

Horizontal Transportable Mass

Positioning Distance – Horizontal Transportable Mass

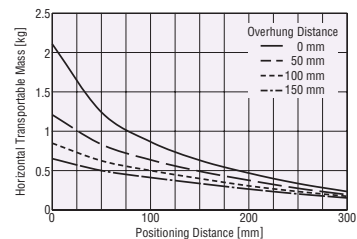

Products equipped with a shaft guide and shaft guide cover can transport loads that are attached directly to the body of the product. Check the horizontal transportable mass in the graph above.

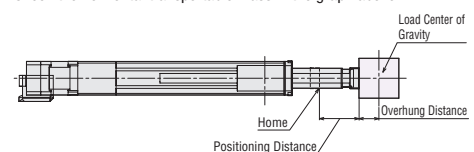

- The positioning distance means the distance from the home position.
- The overhung distance means the distance that the load extends beyond the installation surface.

Dimensions

- Electric Cylinders → Page 121

EACM4RW: Frame Size 42 mm × 114 mm DC Input Reversed Motor Type with Shaft Guide (with Cover)

Product Number

Model	Motor Orientation	Shaft Guide	Lead Screw Pitch	Stroke	Equipped Motor	Motor Type	Motor Specifications	Shaft Guide Cover
EACM4	R	W	D	05	AZ	A	K	-G
EACM4	R: Reversed Motor	W: With Shaft Guide	D: 12 mm E: 6 mm	05: 50 mm 10: 100 mm 15: 150 mm ~ 30: 300 mm (50 mm increment)	AZ Series	A: Single Shaft M: With Electromagnetic Brake	K: DC Input Specifications	-G: With Shaft Guide Cover Blank: No Shaft Guide Cover

Electric Cylinder Specifications

Lead Screw Pitch	mm	12	6		
Electromagnetic Brake (Power Off Activated Type)		Equipped	Not equipped	Equipped	Not equipped
Drive Method		Ball Screw			
Repetitive Positioning Accuracy	mm	±0.02			
Minimum Travel Amount	mm	0.01			
Permissible Moment	Dynamic Permissible Moment	M _e :1.3 M _v :1.3 M _s :0.6			
	Static Permissible Moment	M _e :3.7 M _v :3.7 M _s :3.0			
Transportable Mass	Horizontal Direction	15 Max.		30 Max.	
	Vertical Direction	6 Max.	—	11.5 Max.	—
Thrust	N	70 Max.		125 Max.	
Push Force	N	100		200	
Holding Force	N	70		125	
Maximum Speed	mm/s	600		300	

- For specifications and characteristics of 48 VDC input products, contact your nearest sales office.
- The transportable mass specifications apply when using external linear guide.
When the linear guide is not used, refer to "Horizontal Transportable Mass".
- Since the holding force is lost when the power is not supplied, the load and external force cannot be held in the vertical direction. Select a product with an electromagnetic brake for operation in the vertical direction.
- The maximum speed may decrease depending on the ambient temperature or the length of the motor cable.

Positioning Distance – Positioning Time

The positioning time (reference) can be checked from the positioning distance.

Lead Screw Pitch: 12 mm

Horizontal Installation

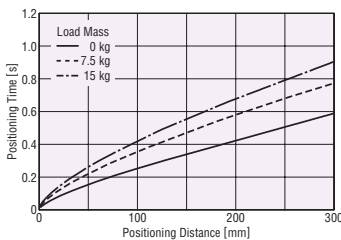

Vertical Installation

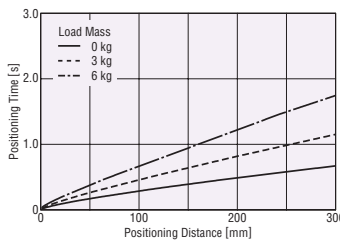

Lead Screw Pitch: 6 mm

Horizontal Installation

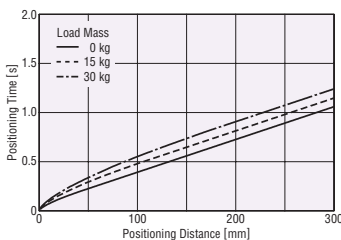

Vertical Installation

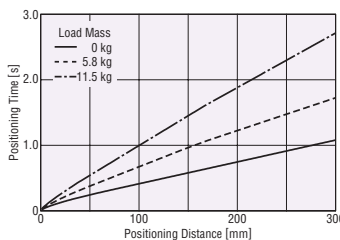

Note

- The starting speed should be 6 mm/s max..

Operating Speed – Thrust

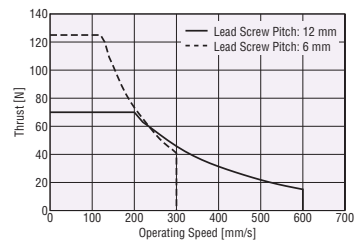

Horizontal Transportable Mass

Positioning Distance – Horizontal Transportable Mass

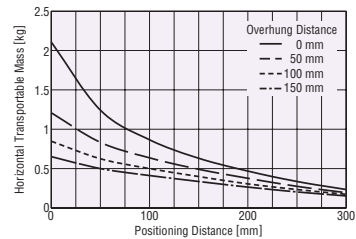

Products equipped with a shaft guide and shaft guide cover can transport loads that are attached directly to the body of the product. Check the horizontal transportable mass in the graph above.

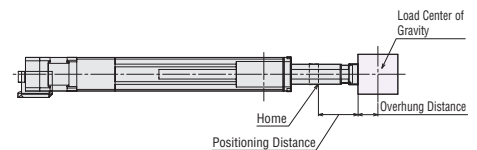

- The positioning distance means the distance from the home position.
- The overhung distance means the distance that the load extends beyond the installation surface.

Dimensions

- Electric Cylinders → Page 122

EACM6W: Frame Size 60 mm × 156 mm AC Input Straight Type with Shaft Guide (with Cover)

Electric
Linear
Slides

QSTEP
AZ Series
Equipped
EZS

QSTEP
AZ Series
Equipped
EAS

Electric
Cylinders

QSTEP
AZ Series
Equipped
EAC

Driver/
Connection
cable

Peripheral
Equipment

Product Number

Model	Shaft Guide	Lead Screw Pitch	Stroke	Equipped Motor	Motor Type	Motor Specifications	Shaft Guide Cover
EACM6	W	D	O5	AZ	A	C	-G
EACM6	W: With Shaft Guide	D: 12 mm E: 6 mm	O5: 50 mm 10: 100 mm 15: 150 mm ~ 30: 300 mm (50 mm increment)	AZ Series	A: Single Shaft M: With Electromagnetic Brake	C: AC Input Specifications	-G: With Shaft Guide Cover Blank: No Shaft Guide Cover

Electric Cylinder Specifications

Lead Screw Pitch	mm	12	6		
Electromagnetic Brake (Power Off Activated Type)		Equipped	Not equipped	Equipped	Not equipped
Drive Method		Ball Screw			
Repetitive Positioning Accuracy	mm	±0.02			
Minimum Travel Amount	mm	0.01			
Permissible Moment	Dynamic Permissible Moment	M _r :2.2 M _v :2.2 M _s :1.3			
	Static Permissible Moment	M _r :7.8 M _v :7.8 M _s :3.0			
Transportable Mass	Horizontal Direction	30 Max.		60 Max.	
	Vertical Direction	13 Max.	—	28 Max.	—
Thrust	N	200 Max.		400 Max.	
Push Force	N	400		500	
Holding Force	N	200		400	
Maximum Speed	mm/s	600		300	

- The transportable mass specifications apply when using external linear guide. When the linear guide is not used, refer to "Horizontal Transportable Mass".
- Since the holding force is lost when the power is not supplied, the load and external force cannot be held in the vertical direction. Select a product with an electromagnetic brake for operation in the vertical direction.

Positioning Distance – Positioning Time

The positioning time (reference) can be checked from the positioning distance.

● Lead Screw Pitch: 12 mm

◇ Horizontal Installation

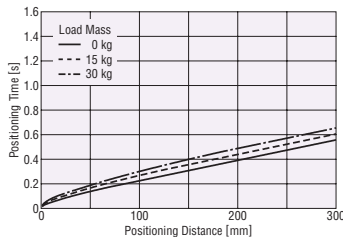

◇ Vertical Installation

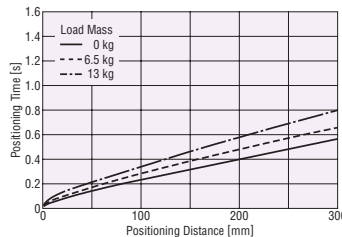

● Lead Screw Pitch: 6 mm

◇ Horizontal Installation

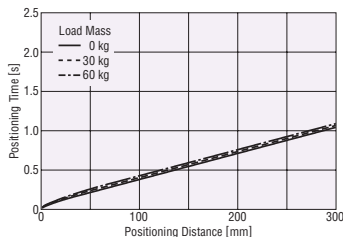

◇ Vertical Installation

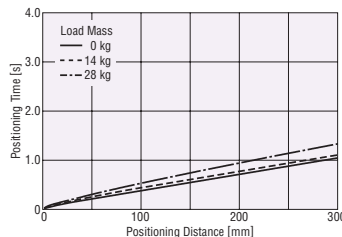

Note

- The starting speed should be 6 mm/s max..

Operating Speed – Thrust

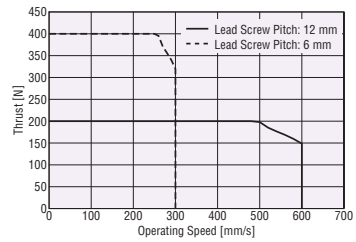

Horizontal Transportable Mass

◇ Positioning Distance – Horizontal Transportable Mass

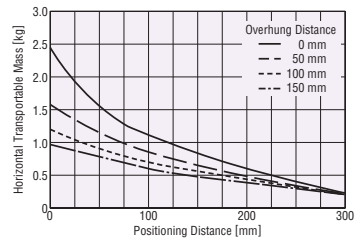

Products equipped with a shaft guide and shaft guide cover can transport loads that are attached directly to the body of the product. Check the horizontal transportable mass in the graph above.

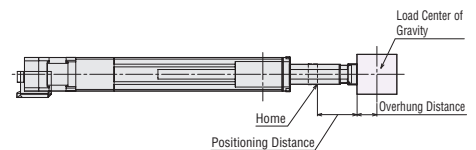

- The positioning distance means the distance from the home position.
- The overhung distance means the distance that the load extends beyond the installation surface.

Dimensions

- Electric Cylinders → Page 123

EACM6RW: Frame Size 60 mm × 156 mm AC Input Reversed Motor Type with Shaft Guide (with Cover)

Product Number

Model	Motor Orientation	Shaft Guide	Lead Screw Pitch	Stroke	Equipped Motor	Motor Type	Motor Specifications	Shaft Guide Cover
EACM6	R	W	D	05	AZ	A	C	-G
EACM6	R: Reversed Motor	W: With Shaft Guide	D: 12 mm E: 6 mm	05: 50 mm 10: 100 mm 15: 150 mm ~ 30: 300 mm (50 mm increment)	AZ Series	A: Single Shaft M: With Electromagnetic Brake	C: AC Input Specifications	-G: With Shaft Guide Cover Blank: No Shaft Guide Cover

Electric Cylinder Specifications

Lead Screw Pitch	mm	12	6		
Electromagnetic Brake (Power Off Activated Type)		Equipped	Not equipped	Equipped	Not equipped
Drive Method		Ball Screw			
Repetitive Positioning Accuracy	mm	±0.02			
Minimum Travel Amount	mm	0.01			
Permissible Moment	Dynamic Permissible Moment	M _r :2.2 M _v :2.2 M _s :1.3			
	Static Permissible Moment	M _r :7.8 M _v :7.8 M _s :3.0			
Transportable Mass	Horizontal Direction	30 Max.		60 Max.	
	Vertical Direction	13 Max.	—	28 Max.	—
Thrust	N	200 Max.		360 Max.	
Push Force	N	400		500	
Holding Force	N	200		360	
Maximum Speed	mm/s	600		300	

- The transportable mass specifications apply when using external linear guide. When the linear guide is not used, refer to "Horizontal Transportable Mass".
- Since the holding force is lost when the power is not supplied, the load and external force cannot be held in the vertical direction. Select a product with an electromagnetic brake for operation in the vertical direction.

Positioning Distance – Positioning Time

The positioning time (reference) can be checked from the positioning distance.

Lead Screw Pitch: 12 mm

Horizontal Installation

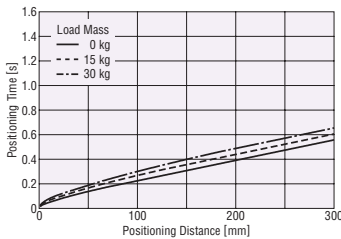

Vertical Installation

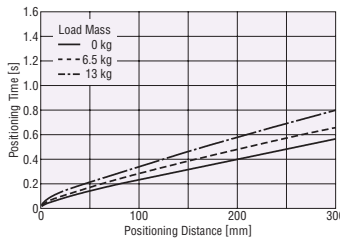

Lead Screw Pitch: 6 mm

Horizontal Installation

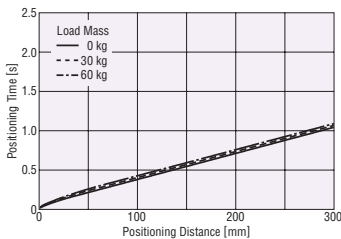

Vertical Installation

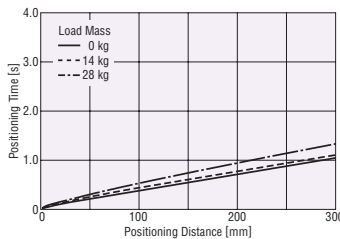

Note

- The starting speed should be 6 mm/s max..

Operating Speed – Thrust

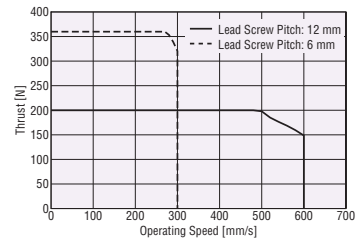

Horizontal Transportable Mass

Positioning Distance – Horizontal Transportable Mass

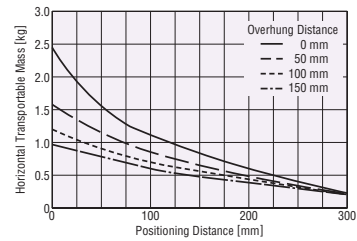

Products equipped with a shaft guide and shaft guide cover can transport loads that are attached directly to the body of the product. Check the horizontal transportable mass in the graph above.

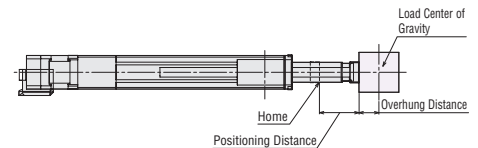

- The positioning distance means the distance from the home position.
- The overhung distance means the distance that the load extends beyond the installation surface.

Dimensions

- Electric Cylinders → Page 124

EACM6W: Frame Size 60 mm × 156 mm DC Input Straight Type with Shaft Guide (with Cover)

Electric
Linear
Slides

QSTEP
AZ Series
Equipped
E2S

QSTEP
AZ Series
Equipped
EAS

Electric
Cylinders

QSTEP
AZ Series
Equipped
EAC

Driver/
Connection
cable

Peripheral
Equipment

Product Number

Model	Shaft Guide	Lead Screw Pitch	Stroke	Equipped Motor	Motor Type	Motor Specifications	Shaft Guide Cover
EACM6	W	D	05	AZ	A	K	-G
EACM6	W: With Shaft Guide	D: 12 mm E: 6 mm	05: 50 mm 10: 100 mm 15: 150 mm ~ 30: 300 mm (50 mm increment)	AZ Series	A: Single Shaft M: With Electromagnetic Brake	K: DC Input Specifications	-G: With Shaft Guide Cover Blank: No Shaft Guide Cover

Electric Cylinder Specifications

Lead Screw Pitch	mm	12	6		
Electromagnetic Brake (Power Off Activated Type)		Equipped	Not equipped	Equipped	Not equipped
Drive Method		Ball Screw			
Repetitive Positioning Accuracy	mm	±0.02			
Minimum Travel Amount	mm	0.01			
Permissible Moment	Dynamic Permissible Moment	Mr:2.2 Mr:2.2 Mr:1.3			
	Static Permissible Moment	Mr:7.8 Mr:7.8 Mr:3.0			
Transportable Mass	Horizontal Direction	30 Max.		60 Max.	
	Vertical Direction	13 Max.	—	28 Max.	—
Thrust	N	200 Max.		400 Max.	
Push Force	N	400		500	
Holding Force	N	200		400	
Maximum Speed	mm/s	600		300	

- For specifications and characteristics of 48 VDC input products, contact your nearest sales office.
- The transportable mass specifications apply when using external linear guide.
When the linear guide is not used, refer to "Horizontal Transportable Mass".
- Since the holding force is lost when the power is not supplied, the load and external force cannot be held in the vertical direction. Select a product with an electromagnetic brake for operation in the vertical direction.
- The maximum speed may decrease depending on the ambient temperature or the length of the motor cable.

Positioning Distance – Positioning Time

The positioning time (reference) can be checked from the positioning distance.

● Lead Screw Pitch: 12 mm

◇ Horizontal Installation

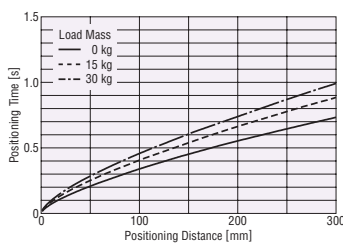

◇ Vertical Installation

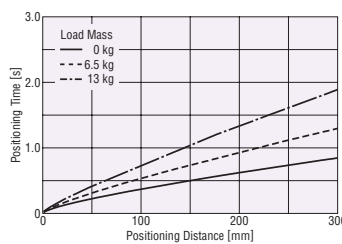

● Lead Screw Pitch: 6 mm

◇ Horizontal Installation

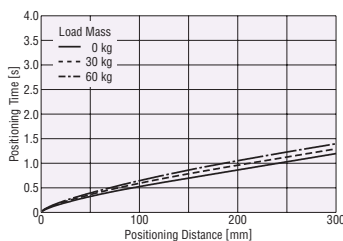

◇ Vertical Installation

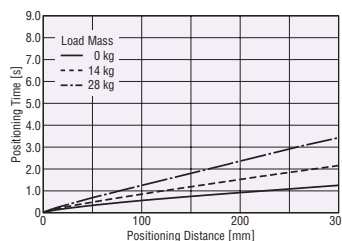

Note

- The starting speed should be 6 mm/s max..

Operating Speed – Thrust

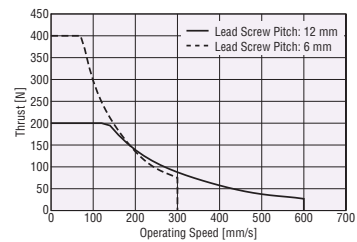

Horizontal Transportable Mass

◇ Positioning Distance – Horizontal Transportable Mass

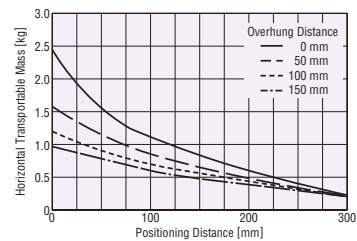

Products equipped with a shaft guide and shaft guide cover can transport loads that are attached directly to the body of the product. Check the horizontal transportable mass in the graph above.

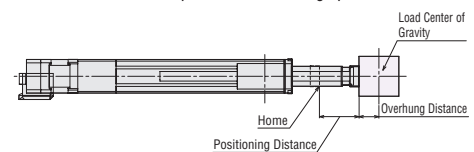

- The positioning distance means the distance from the home position.
- The overhung distance means the distance that the load extends beyond the installation surface.

Dimensions

- Electric Cylinders → Page 123

EACM6RW: Frame Size 60 mm × 156 mm DC Input Reversed Motor Type with Shaft Guide (with Cover)

Product Number

Model	Motor Orientation	Shaft Guide	Lead Screw Pitch	Stroke	Equipped Motor	Motor Type	Motor Specifications	Shaft Guide Cover
EACM6	R	W	D	05	AZ	A	K	-G
EACM6	R: Reversed Motor	W: With Shaft Guide	D: 12 mm E: 6 mm	05: 50 mm 10: 100 mm 15: 150 mm ~ 30: 300 mm (50 mm increment)	AZ Series	A: Single Shaft M: With Electromagnetic Brake	K: DC Input Specifications	-G: With Shaft Guide Cover Blank: No Shaft Guide Cover

Electric Cylinder Specifications

Lead Screw Pitch		mm	12	6		
Electromagnetic Brake (Power Off Activated Type)		Equipped	Not equipped	Equipped	Not equipped	
Drive Method		Ball Screw				
Repetitive Positioning Accuracy		mm	±0.02			
Minimum Travel Amount		mm	0.01			
Permissible Moment	Dynamic Permissible Moment	Nm	Mr:2.2 Mr:2.2 Mr:1.3			
	Static Permissible Moment		Mr:7.8 Mr:7.8 Mr:3.0			
Transportable Mass	Horizontal Direction	kg	30 Max.		60 Max.	
	Vertical Direction		13 Max.	—	28 Max.	—
Thrust		N	200 Max.		360 Max.	
Push Force		N	400		500	
Holding Force		N	200		360	
Maximum Speed		mm/s	600		300	

- For specifications and characteristics of 48 VDC input products, contact your nearest sales office.
- The transportable mass specifications apply when using external linear guide.
When the linear guide is not used, refer to "Horizontal Transportable Mass".
- Since the holding force is lost when the power is not supplied, the load and external force cannot be held in the vertical direction. Select a product with an electromagnetic brake for operation in the vertical direction.
- The maximum speed may decrease depending on the ambient temperature or the length of the motor cable.

Positioning Distance – Positioning Time

The positioning time (reference) can be checked from the positioning distance.

● Lead Screw Pitch: 12 mm

◇ Horizontal Installation

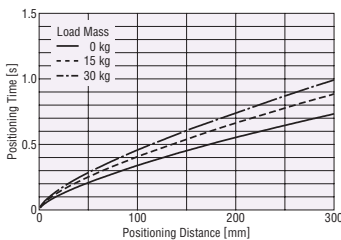

◇ Vertical Installation

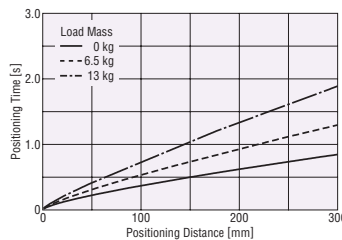

● Lead Screw Pitch: 6 mm

◇ Horizontal Installation

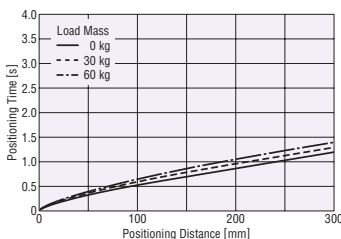

◇ Vertical Installation

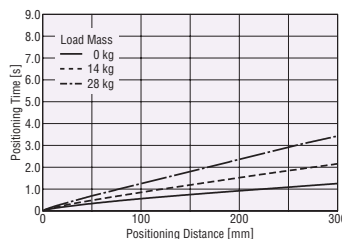

Note

- The starting speed should be 6 mm/s max..

Operating Speed – Thrust

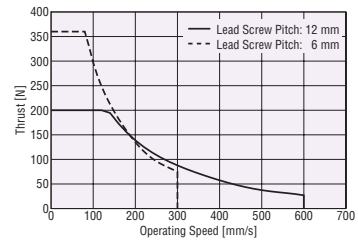

Horizontal Transportable Mass

◇ Positioning Distance – Horizontal Transportable Mass

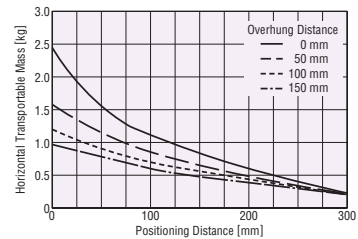

Products equipped with a shaft guide and shaft guide cover can transport loads that are attached directly to the body of the product. Check the horizontal transportable mass in the graph above.

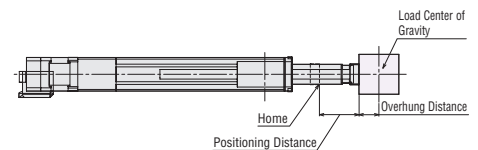

- The positioning distance means the distance from the home position.
- The overhang distance means the distance that the load extends beyond the installation surface.

Dimensions

- Electric Cylinders → Page 124

Electromagnetic Brake Specifications

Product Name	EACM4	EACM6
Brake Type	Power Off Activated Type	
Power Supply Voltage	24 VDC ± 5%*	
Power Supply Current	A	0.08 0.25
Time Rating	Continuous	

*For the type with an electromagnetic brake, a 24 VDC ± 4% specification applies if the wiring distance between the motor and driver is extended to 20 m using a cable.

General Specifications

		AC Input	DC Input
Thermal Class		130 (B) [UL/CSA: 105 (A)]	
Insulation Resistance		100 MΩ or more when a 500 VDC megger is applied between the following places: <ul style="list-style-type: none"> • Case – Motor Windings • Case – Electromagnetic Brake Windings*1 	
Dielectric Strength		Sufficient to withstand the following for 1 minute: EACM4, EACM6 <ul style="list-style-type: none"> • Case – Motor Windings 1.5 kVAC, 50 Hz or 60 Hz • Case – Electromagnetic Brake Windings*1 1.5 kVAC, 50 Hz or 60 Hz 	Sufficient to withstand the following for 1 minute: EACM2 <ul style="list-style-type: none"> • Case – Motor Windings 0.5 kVAC, 50 Hz or 60 Hz EACM4, EACM6 <ul style="list-style-type: none"> • Case – Motor Windings 1.0 kVAC 50 Hz or 60 Hz • Case – Electromagnetic Brake Windings*1 1.0 kVAC 50 Hz or 60 Hz
Operating Environment (In Operation)	Ambient Temperature	0 to +40°C (Non-freezing)*3	
	Ambient Humidity	85% or less (Non-condensing)	
	Atmosphere	No corrosive gases or dust. The product should not be exposed to water, oil or other liquids.	
Degree of Protection*2		EACM2 : IP40 (excluding installation surfaces and connector locations) EACM4, EACM6 : IP66 (excluding installation surfaces and connector locations)	
Multiple Rotation Detection Range in Power OFF State		EACM2 : ±450 Rotations (900 Rotations) EACM4, EACM6 : ±900 Rotations (1800 Rotations)	

*1 Only for products with an electromagnetic brake.

*2 Only for motor parts. The degree of protection of the electric cylinder is IP00.

*3 It is based on Oriental Motor's measurement conditions.

Note

- Disconnect the motor and driver when taking an insulation resistance measurement or performing a dielectric voltage withstand test. Also, do not perform these tests on the ABZO sensor (absolute sensor) part of the motor.

Electric Linear Slides

QSTEP AZ Series Equipped EZS

QSTEP AZ Series Equipped EAS

Electric Cylinders

QSTEP AZ Series Equipped EAC

Driver/Connection cable

Peripheral Equipment

Moving Direction

At the time of shipment, the moving direction of the rod is set as shown below.

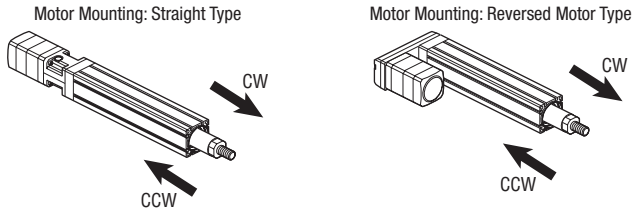

Actuator Installation

When installing the actuator, pay particular attention to the installation location, because the ABZO sensor (absolute sensor) can easily be affected by magnetic force.

When Installing EACM2

When installing the motor parts in parallel, leave a buffer space that is equal to or greater than the motor's size (frame size) both horizontally and vertically.

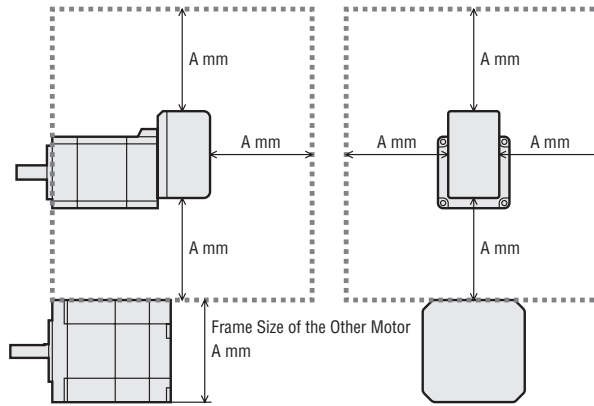

Reference

The Other Motor	A
Frame Size 20 mm	20
Frame Size 28 mm	28
Frame Size 42 mm	42
Frame Size 60 mm	60

When installing the actuator in an environment where a magnetic field is generated

Make sure that the magnetic flux density on the surface of the ABZO sensor (absolute sensor) does not exceed the values in the table.

Product Name	Magnetic Flux Density
EACM2	2 mT*
EACM4, EACM6	10 mT

*When the magnetic flux density exceeding 1 mT and below 2 mT, please use the actuator at ambient temperature exceeding 20°C and below 40°C.

Dimensions (Unit: mm)

● EACM2 Straight Type

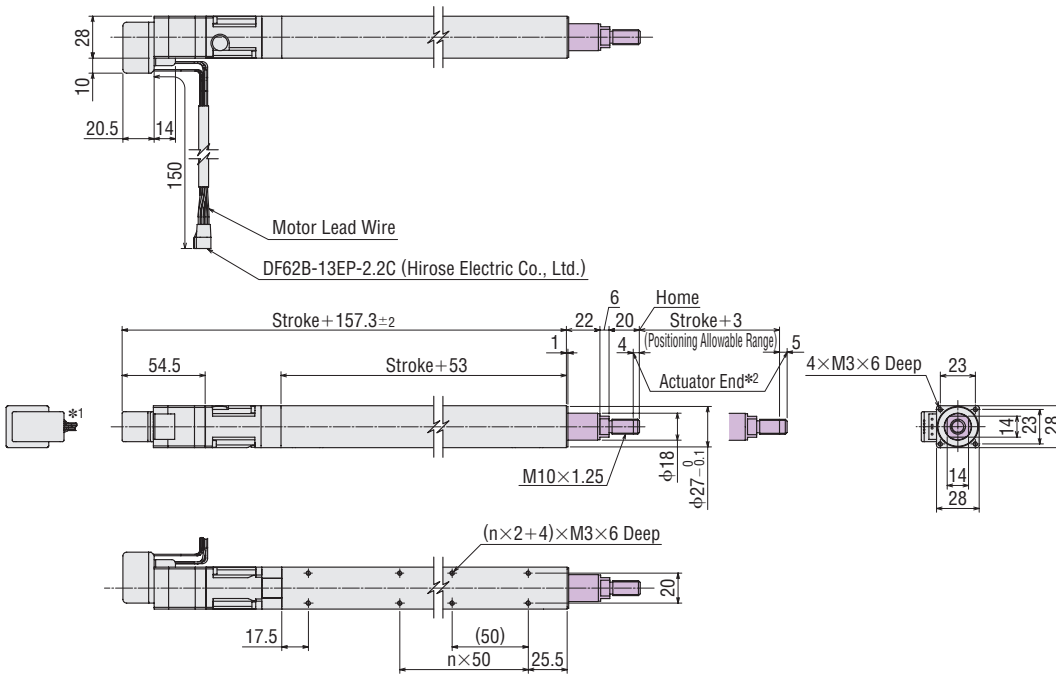

● Included Nut (1 Piece)

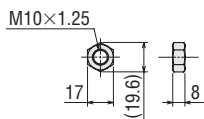

*1 The direction of the motor lead can be changed in 90° intervals in four directions.

*2 At the push-motion return-to-home operation, the rod moves to the mechanical limit position. The push-motion return-to-home operation cannot move the rod to the far end from the motor.

● The shaded areas are moving parts.

Stroke [mm]	50	100	150	
Hole Coefficient (n)	1	2	3	
Mass [kg]	Single Shaft	0.46	0.54	0.61

Electric
Linear
Slides

Q_{STEP}
AZ Series
Equipped
E_{ZS}

Q_{STEP}
AZ Series
Equipped
E_{AS}

Electric
Cylinders

Q_{STEP}
AZ Series
Equipped
E_{AC}

Driver/
Connection
cable

Peripheral
Equipment

● **EACM4 Straight Type**

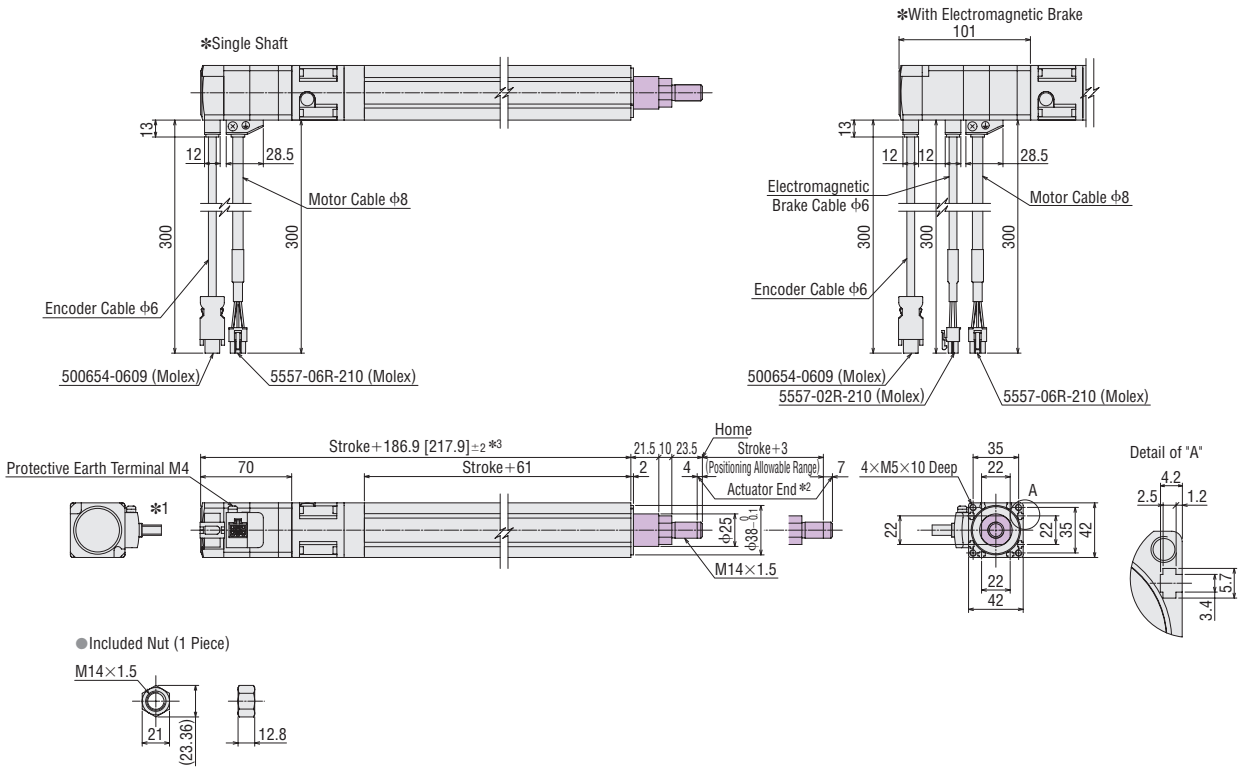

*1 The direction of the motor cable can be changed in 90° intervals in four directions.

*2 At the push-motion return-to-home operation, the rod moves to the mechanical limit position. The push-motion return-to-home operation cannot move the rod to the far end from the motor.

*3 The brackets [] indicate the values for the electromagnetic brake product.

● The shaded areas are moving parts.

Stroke [mm]		50	100	150	200	250	300
Mass [kg]	Single Shaft	1.0	1.2	1.4	1.6	1.7	1.9
	With Electromagnetic Brake	1.2	1.4	1.6	1.8	1.9	2.1

● **EACM4R** Reversed Motor Type

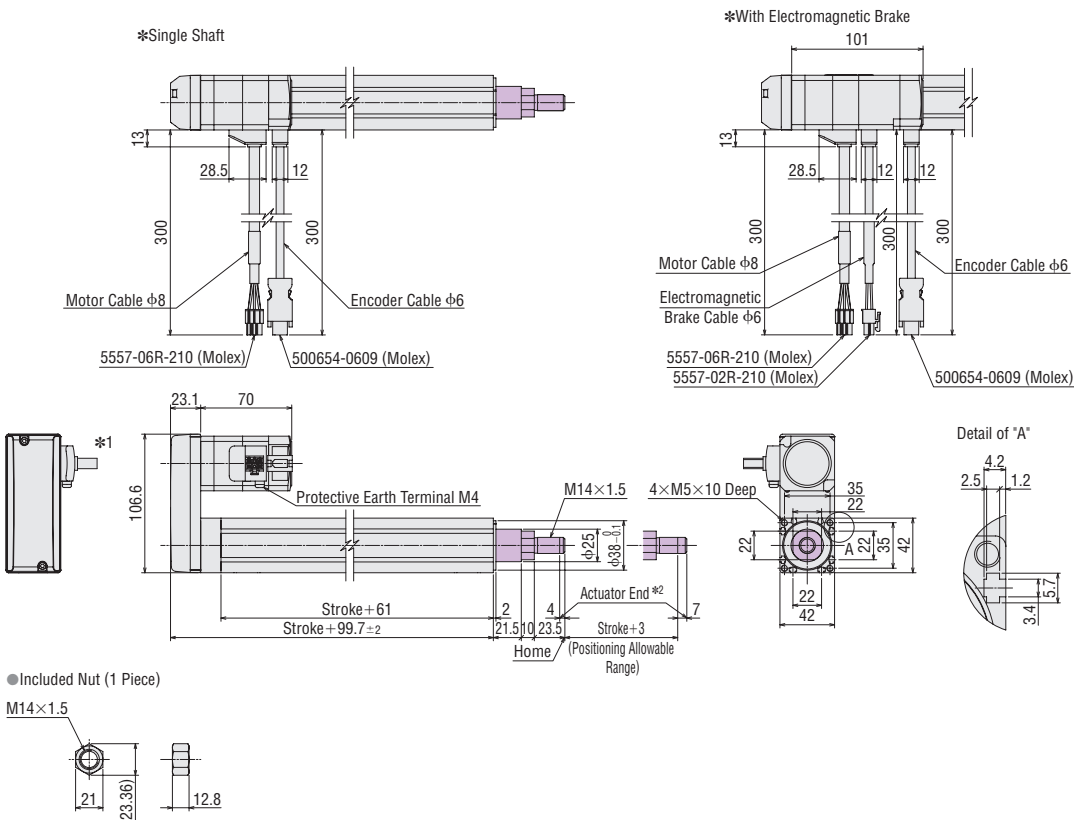

- *1 The direction of the motor cable can be changed in 90° intervals in three directions.
- *2 At the push-motion return-to-home operation, the rod moves to the mechanical limit position. The push-motion return-to-home operation cannot move the rod to the far end from the motor.
- The shaded areas are moving parts.

Stroke [mm]		50	100	150	200	250	300
Mass [kg]	Single Shaft	1.0	1.2	1.4	1.6	1.7	1.9
	With Electromagnetic Brake	1.2	1.4	1.6	1.8	1.9	2.1

Electric Linear Slides

QSTEP AZ Series Equipped EZS

QSTEP AZ Series Equipped EAS

Electric Cylinders

QSTEP AZ Series Equipped EAC

Driver/ Connection cable

Peripheral Equipment

● **EACM6 Straight Type**

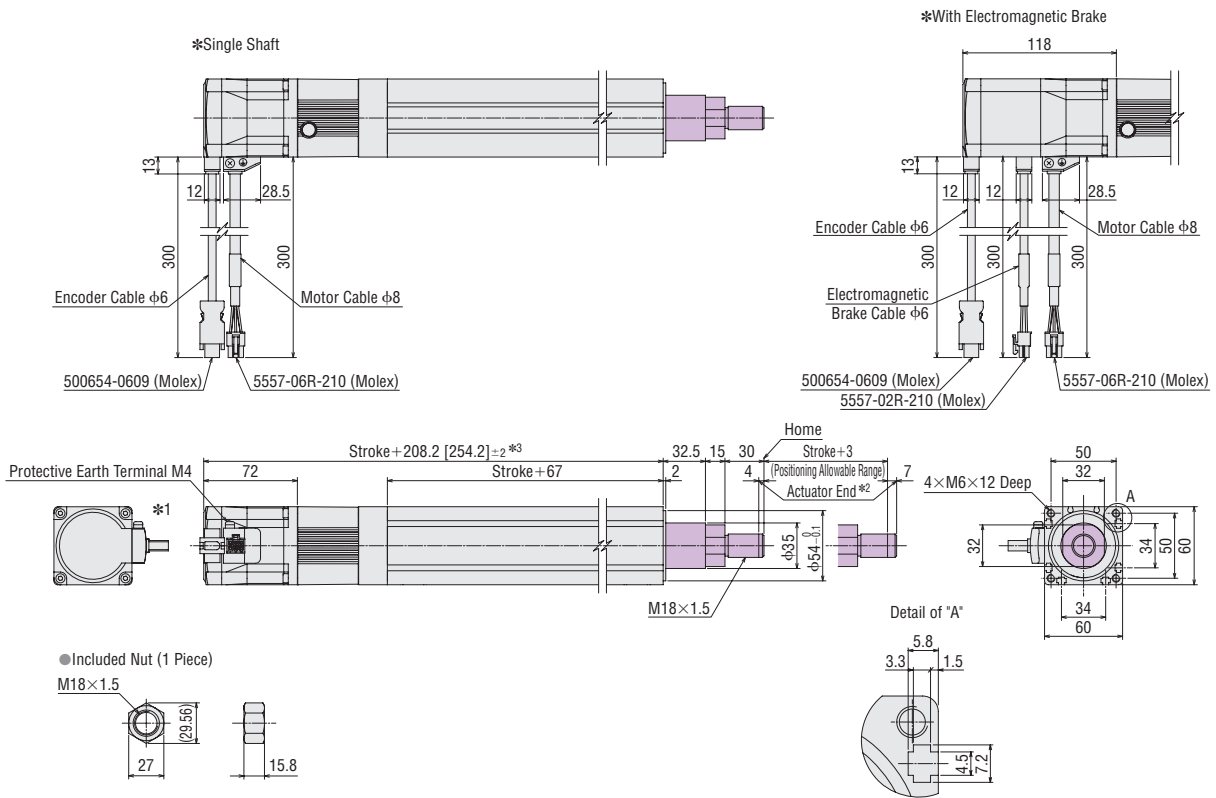

- *1 The direction of the motor cable can be changed in 90° intervals in four directions.
- *2 At the push-motion return-to-home operation, the rod moves to the mechanical limit position. The push-motion return-to-home operation cannot move the rod to the far end from the motor.
- *3 The brackets [] indicate the values for the electromagnetic brake product.
- The shaded areas are moving parts.

Stroke [mm]		50	100	150	200	250	300
Mass [kg]	Single Shaft	2.6	3.0	3.4	3.7	4.1	4.5
	With Electromagnetic Brake	3.0	3.4	3.8	4.1	4.5	4.9

● **EACM6R** Reversed Motor Type

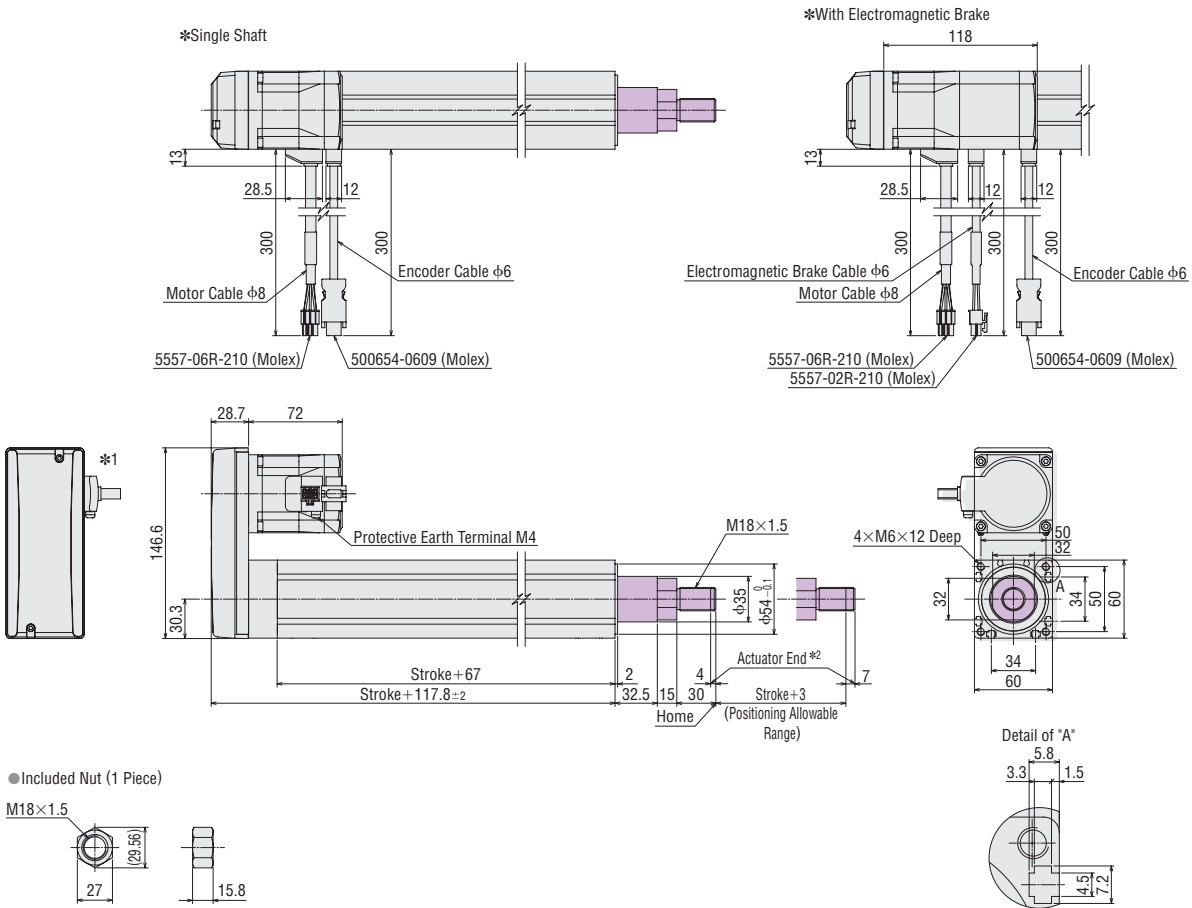

*1 The direction of the motor cable can be changed in 90° intervals in three directions.

*2 At the push-motion return-to-home operation, the rod moves to the mechanical limit position. The push-motion return-to-home operation cannot move the rod to the far end from the motor.

● The shaded areas are moving parts.

Stroke [mm]		50	100	150	200	250	300
Mass [kg]	Single Shaft	2.6	3.0	3.4	3.7	4.1	4.5
	With Electromagnetic Brake	3.0	3.4	3.8	4.1	4.5	4.9

Electric Linear Slides

Q-STEP AZ Series Equipped EZS

Q-STEP AZ Series Equipped EAS

Electric Cylinders

Q-STEP AZ Series Equipped EAC

Driver/ Connection cable

Peripheral Equipment

● **EACM2W** Straight Type with Shaft Guide Cover

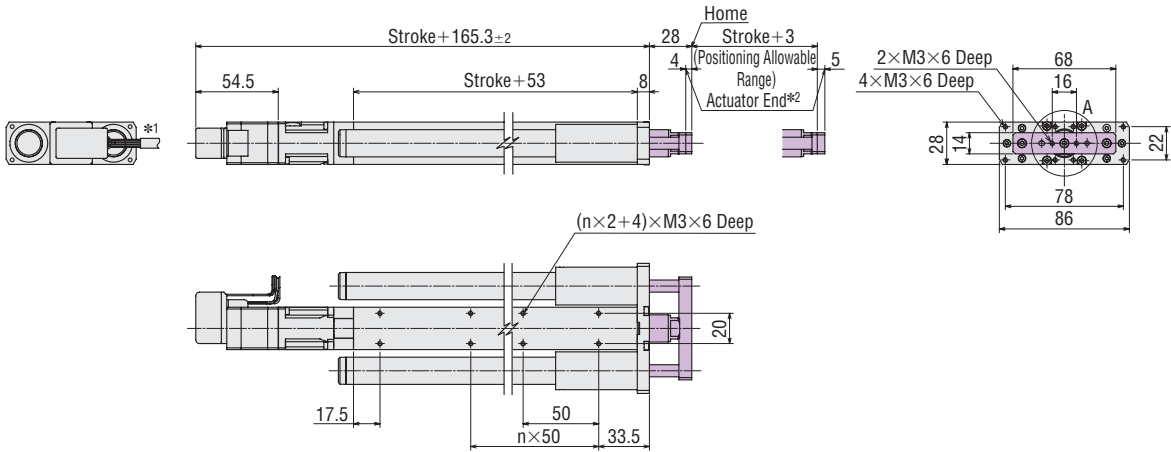
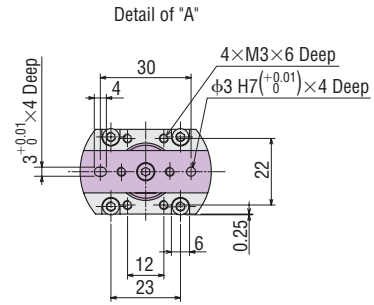
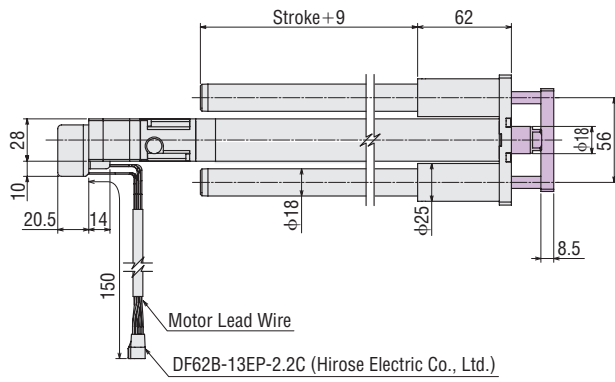

*1 The direction of the motor lead can be changed in 90° intervals in four directions.

*2 At the push-motion return-to-home operation, the rod moves to the mechanical limit position. The push-motion return-to-home operation cannot move the rod to the far end from the motor.

● The shaded areas are moving parts.

Stroke [mm]		50	100	150
Hole Coefficient (n)		1	2	3
Mass [kg]	Single Shaft	0.78	0.92	1.10

● **EACM4W** Straight Type with Shaft Guide/with Shaft Guide Cover

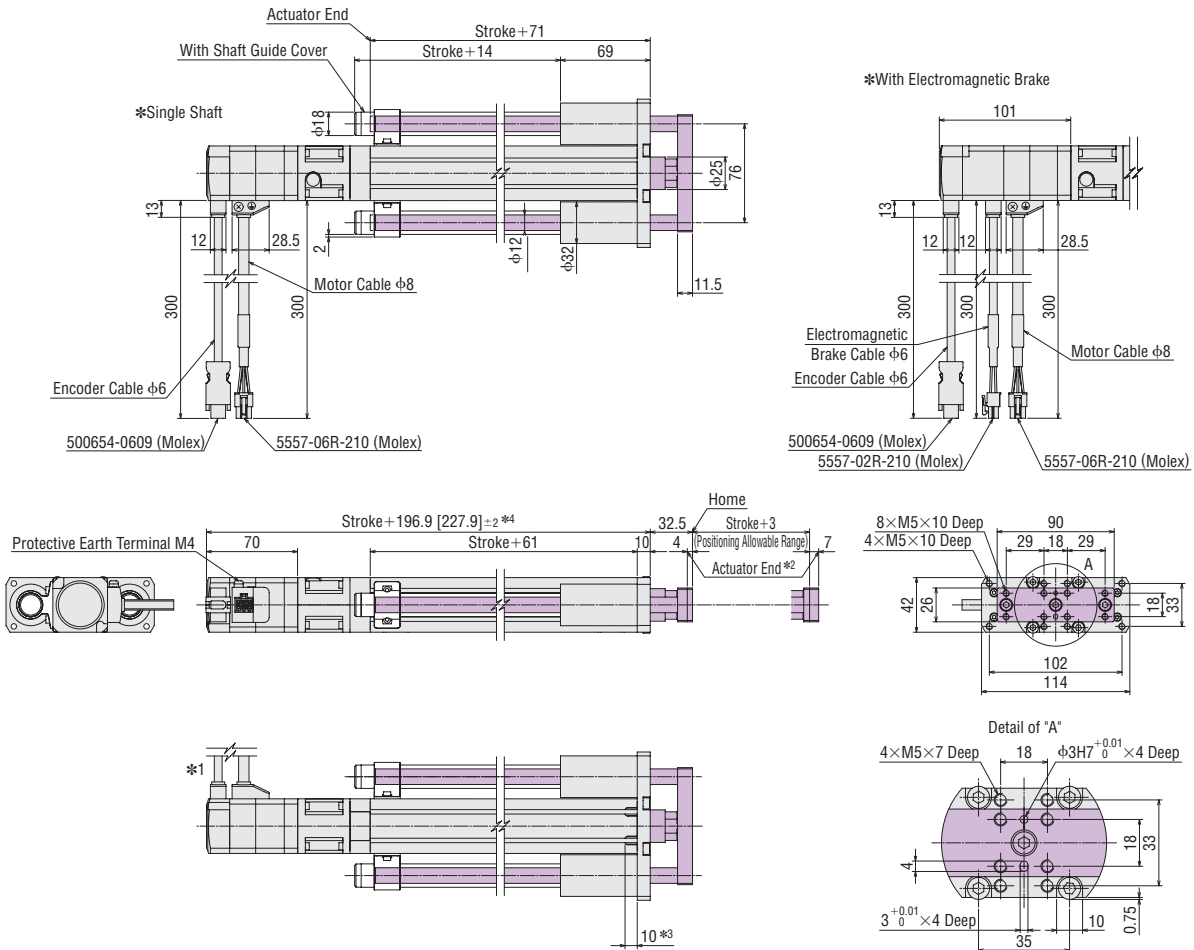

- *1 The direction of the motor cable can be changed in 90° intervals in four directions.
- *2 At the push-motion return-to-home operation, the rod moves to the mechanical limit position. The push-motion return-to-home operation cannot move the rod to the far end from the motor.
- *3 The installation plate foot type cannot be installed on this part.
- *4 The brackets [] indicate the values for the electromagnetic brake product.
- The shaded areas are moving parts.

Stroke [mm]	50	100	150	200	250	300
With Shaft Guide	1.7 (1.9)	2.0 (2.2)	2.3 (2.5)	2.5 (2.7)	2.8 (3.0)	3.1 (3.3)
With Shaft Guide Cover	1.8 (1.9)	2.1 (2.3)	2.4 (2.6)	2.6 (2.8)	3.0 (3.1)	3.3 (3.5)

● Values in () indicate the mass of the type with an electromagnetic brake.

Electric Linear Slides

QSTEP AZ Series Equipped E2S

QSTEP AZ Series Equipped EAS

Electric Cylinders

QSTEP AZ Series Equipped EAC

Driver/ Connection cable

Peripheral Equipment

● **EACM4RW** Reversed Motor Type with Shaft Guide/with Shaft Guide Cover

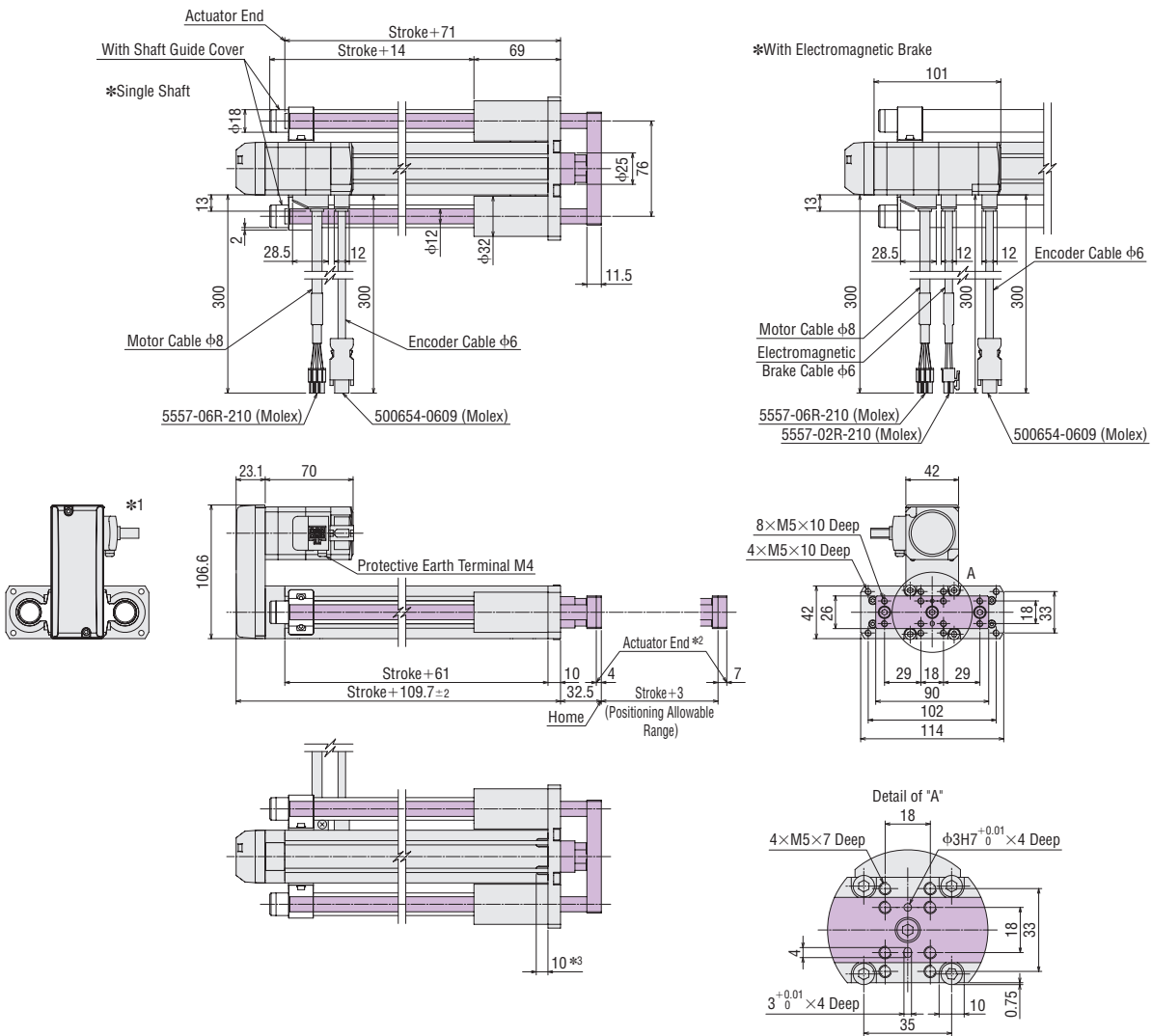

- *1 The direction of the motor cable can be changed in 90° intervals in three directions.
- *2 At the push-motion return-to-home operation, the rod moves to the mechanical limit position. The push-motion return-to-home operation cannot move the rod to the far end from the motor.
- *3 The installation plate foot type cannot be installed on this part.
- The shaded areas are moving parts.

Stroke [mm]	50	100	150	200	250	300	
Mass [kg]	With Shaft Guide	1.7 (1.9)	2.0 (2.2)	2.3 (2.5)	2.5 (2.7)	2.8 (3.0)	3.1 (3.3)
	With Shaft Guide Cover	1.8 (1.9)	2.1 (2.3)	2.4 (2.6)	2.6 (2.8)	3.0 (3.1)	3.3 (3.5)

● Values in () indicate the mass of the type with an electromagnetic brake.

● **EACM6W** Straight Type with Shaft Guide/with Shaft Guide Cover

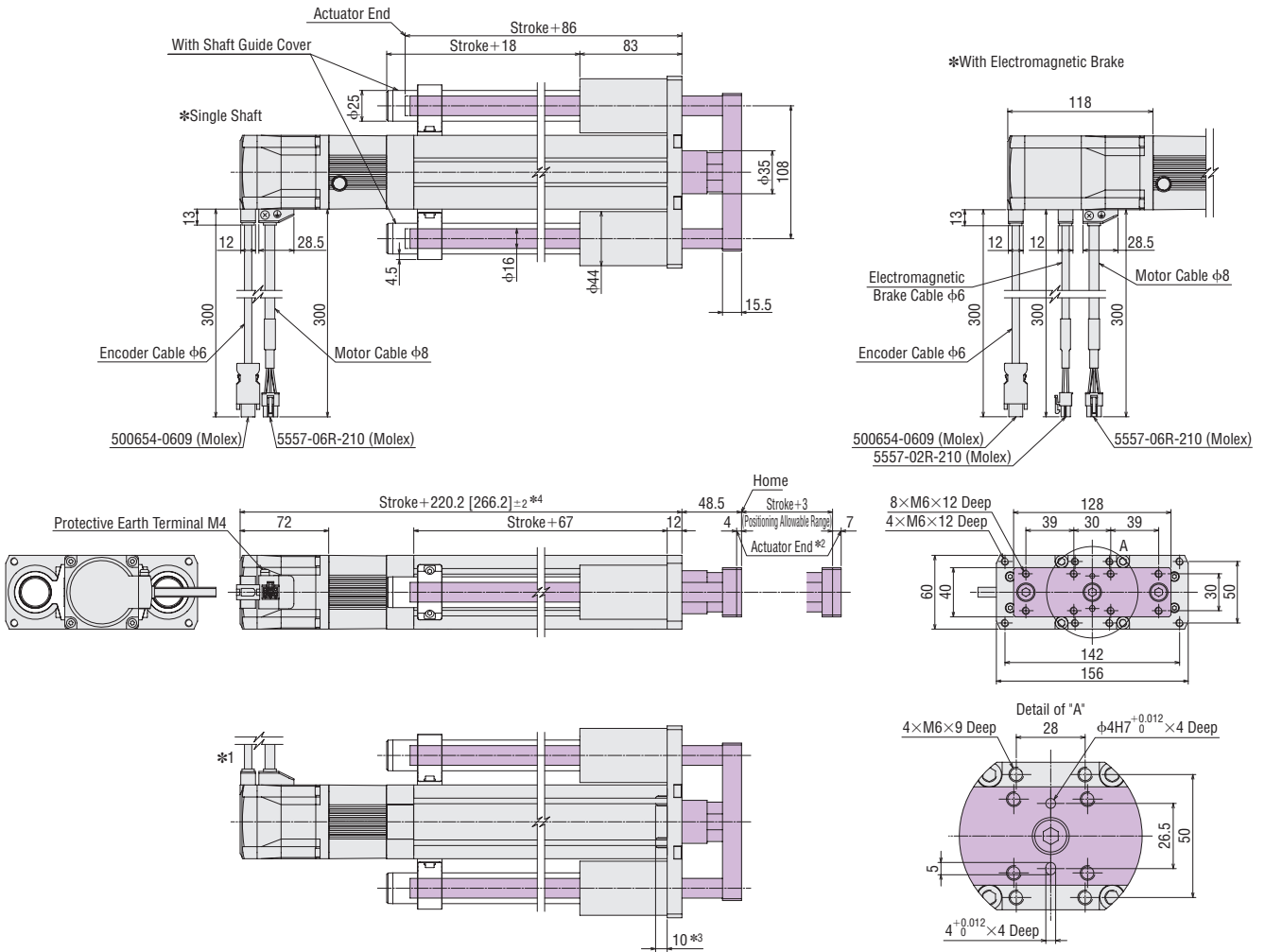

- *1 The direction of the motor cable can be changed in 90° intervals in four directions.
- *2 At the push-motion return-to-home operation, the rod moves to the mechanical limit position. The push-motion return-to-home operation cannot move the rod to the far end from the motor.
- *3 The installation plate foot type cannot be installed on this part.
- *4 The brackets [] indicate the values for the electromagnetic brake product.
- The shaded areas are moving parts.

Stroke [mm]		50	100	150	200	250	300
Mass [kg]	With Shaft Guide	4.1 (4.5)	4.7 (5.1)	5.2 (5.6)	5.7 (6.1)	6.3 (6.7)	6.8 (7.2)
	With Shaft Guide Cover	4.2 (4.6)	4.9 (5.3)	5.4 (5.8)	6.0 (6.4)	6.6 (7.0)	7.2 (7.6)

● Values in () indicate the mass of the type with an electromagnetic brake.

Electric Linear Slides

QSTEP AZ Series Equipped EZS

QSTEP AZ Series Equipped EAS

Electric Cylinders

QSTEP AZ Series Equipped EAC

Driver/ Connection cable

Peripheral Equipment

● **EACM6RW** Reversed Motor Type with Shaft Guide/with Shaft Guide Cover

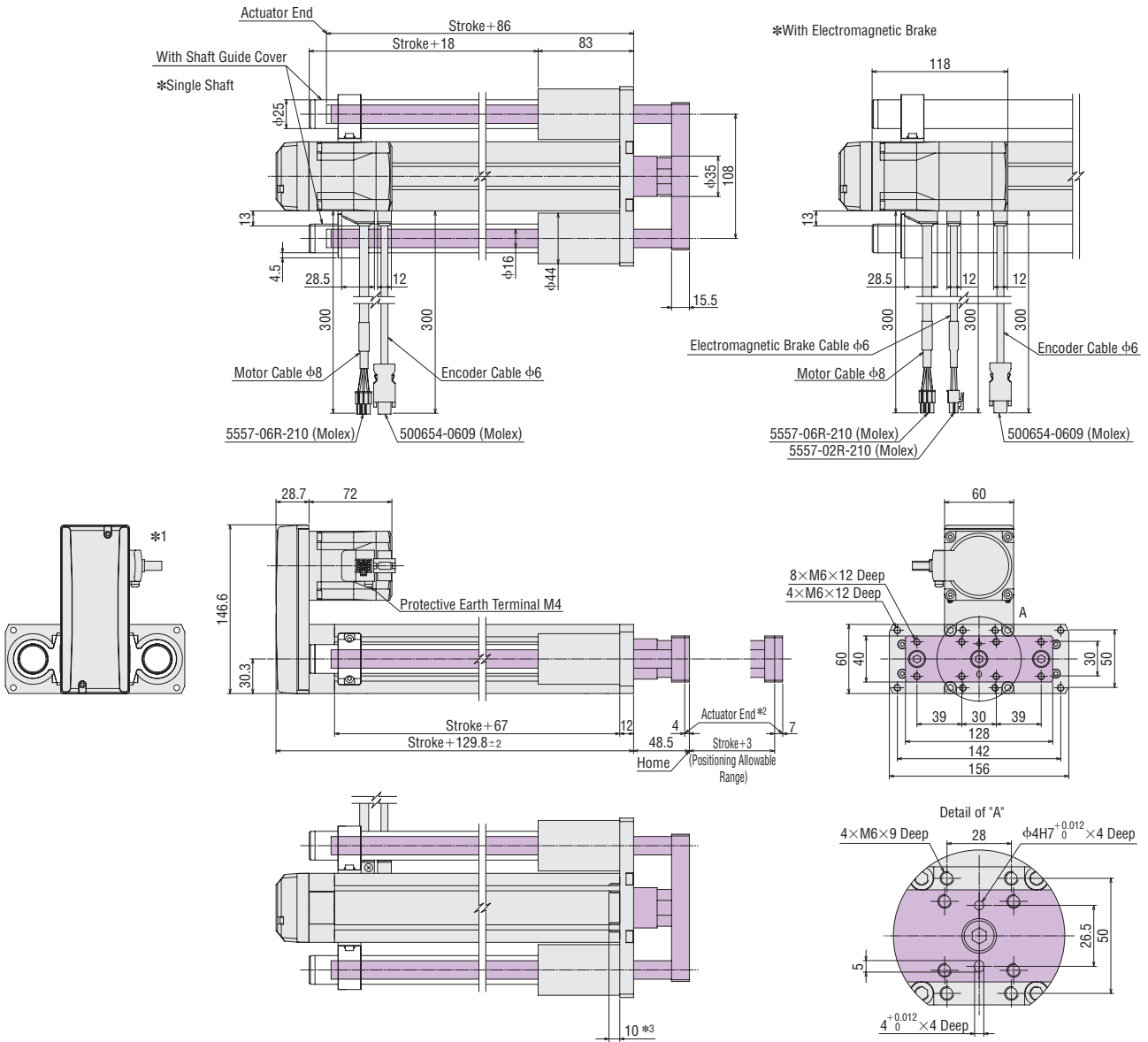

- *1 The direction of the motor cable can be changed in 90° intervals in three directions.
- *2 At the push-motion return-to-home operation, the rod moves to the mechanical limit position. The push-motion return-to-home operation cannot move the rod to the far end from the motor.
- *3 The installation plate foot type cannot be installed on this part.
- The shaded areas are moving parts.

Stroke [mm]		50	100	150	200	250	300
Mass [kg]	With Shaft Guide	4.1 (4.5)	4.7 (5.1)	5.2 (5.6)	5.7 (6.1)	6.3 (6.7)	6.8 (7.2)
	With Shaft Guide Cover	4.2 (4.6)	4.9 (5.3)	5.4 (5.8)	6.0 (6.4)	6.6 (7.0)	7.2 (7.6)

● Values in () indicate the mass of the type with an electromagnetic brake.

About Use of the EACM6 (AC Input Type) for Vertical Driving

When operating **EACM6*** type electric cylinders in the vertical direction, depending on the driving conditions, an overvoltage protection alarm may be detected. In such case, refer to the operating speed - load mass characteristics diagram, and connect the Oriental Motor's **RGB100** regeneration resistor to the driver.

*Common to all AC input specifications of **D** (lead screw pitch 12 mm)/**E** (lead screw pitch 6 mm), Straight/ Reversed motor type.

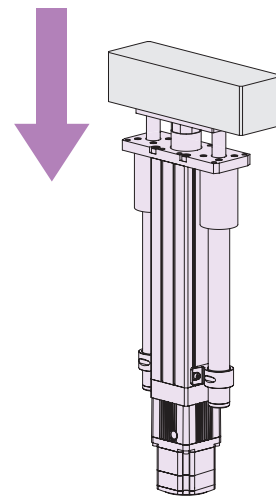

Example of Vertical Use

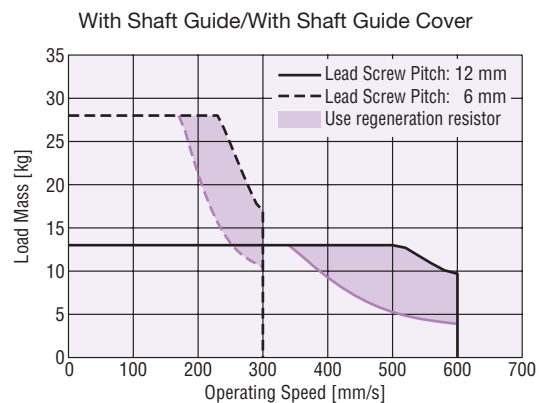
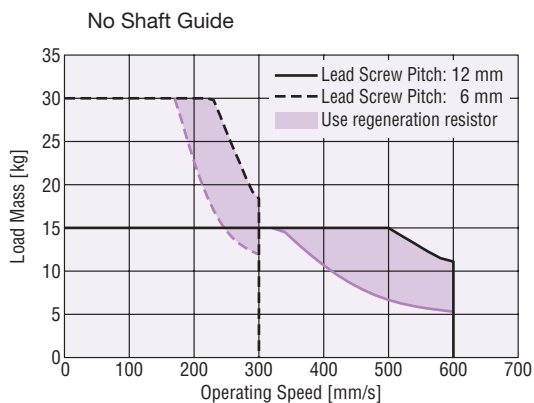

Region in which the regeneration resistor is required for **EACM6** type (AC Input Type)

● Regeneration Resistor

When a regeneration resistor is attached to the special terminal on the driver, the regenerative power that is fed back from the motor is released as thermal energy.



◇ Product Line

Product Name	Applicable Product	List Price
RGB100	AC Input Drivers	45.00 €

◇ Specifications

Item	Specifications
Continuous Regenerative Power	50W
Resistance Value	150Ω
Thermostat Operating Temperature	Open: 150±7°C Close: 145±12°C (Normally Closed)
Thermostat Electrical Rating	120 VAC 4 A 30 VDC 4 A (Minimum current 5 mA)

● Install the regeneration resistor in the place which has the same heat radiation capability as heat radiation plate [Material: Aluminum 350 mm×350 mm, 3 mm thick].

αSTEP AZ Series Drivers (Common to all series)

Types and Features

● αSTEP AZ Series Drivers

The drivers can be selected according to the host controller to be used.

◇ Built-in Controller Type
FLEX



Set the positioning data in the driver (256 points). Industrial network control is possible by using a network converter (sold separately).

● For product details, please refer to the **AZ** Series Brochure.

● **FLEX** FLEX is the collective name for products that support I/O control, Modbus (RTU) control, and FA network control via network converters.

◇ Pulse Input Type with RS-485 Communication



Motor position, speed, alarm and temperature can be monitored by RS-485 communication.

◇ Pulse Input Type



Can be controlled by a positioning module (pulse generator).

◇ Network Compatible Drivers



Drivers compatible with EtherNet/IP, EtherCAT drive profile, and PROFINET. Direct control from the network is possible.

AC Input

Product Number

AZD - C D

① ② ③

①	Driver Type	AZD: AZ Series Driver
②	Power Supply Input	A: Single-Phase 100-120 VAC C: Single-Phase/Three-Phase 200-240 VAC
③	Type	D: Built-in Controller Type X: Pulse Input Type with RS-485 Communication Blank: Pulse Input Type EP: EtherNet/IP Compatible ED: EtherCAT Drive Profile Compatible PN: PROFINET Compatible

Product Line

● Driver

◇ Built-in Controller Type



Power Supply Input	Product Name	List Price
Single-Phase 100-120 VAC	AZD-AD	528.00 €
Single-Phase/Three-Phase 200-240 VAC	AZD-CD	528.00 €

◇ Pulse Input Type with RS-485 Communication



Power Supply Input	Product Name	List Price
Single-Phase 100-120 VAC	AZD-AX	528.00 €
Single-Phase/Three-Phase 200-240 VAC	AZD-CX	528.00 €

◇ Pulse Input Type



Power Supply Input	Product Name	List Price
Single-Phase 100-120 VAC	AZD-A	473.00 €
Single-Phase/Three-Phase 200-240 VAC	AZD-C	473.00 €

◇ EtherNet/IP Compatible Type



Power Supply Input	Product Name	List Price
Single-Phase 100-120 VAC	AZD-AEP	572.00 €
Single-Phase/Three-Phase 200-240 VAC	AZD-CEP	572.00 €

◇ EtherCAT Drive Profile Compatible Type



Power Supply Input	Product Name	List Price
Single-Phase 100-120 VAC	AZD-AED	572.00 €
Single-Phase/Three-Phase 200-240 VAC	AZD-CED	572.00 €

◇ PROFINET Compatible Type



Power Supply Input	Product Name	List Price
Single-Phase 100-120 VAC	AZD-APN	572.00 €
Single-Phase/Three-Phase 200-240 VAC	AZD-CPN	572.00 €

Included

Type	Included	Connector
Built-in Controller Type Pulse Input Type with RS-485 Communication Pulse Input Type		<ul style="list-style-type: none"> • CN1 Connector (1 pc.) • CN4 Connector (1 pc.) • CN5 Connector (1 pc.) • Connector Lever (1 pc.)
EtherNet/IP Compatible EtherCAT Drive Profile Compatible PROFINET Compatible		<ul style="list-style-type: none"> • CN1 Connector (1 pc.) • CN4 Connector (1 pc.) • CN7 Connector (1 pc.) • Connector Lever (1 pc.)

Driver Specifications

Driver Product Name		AZD-AD AZD-AX AZD-A AZD-AEP AZD-AED AZD-APN	AZD-CD AZD-CX AZD-C AZD-CEP AZD-CED AZD-CPN	
Main Power Supply	Input Voltage	Single-Phase 100-120 VAC -15 to +6% 50/60 Hz	Single-Phase 200-240 VAC -15 to +6% 50/60 Hz	Three-Phase 200-240 VAC -15 to +6% 50/60 Hz
	Input Current	EZSM3, EZSM4, EASM4, EACM4 EZSM6, EASM6, EACM6	2.7 A 3.8 A	1.7 A 2.3 A
Control Power Supply	Input Voltage	24 VDC ±5%*1		
	Input Current	0.25 A (0.5 A)*2		

*1 If the electromagnetic brake type is extended 20 m with a cable, the specification becomes 24 VDC ±4%.

*2 The parentheses () indicate the specifications for the electromagnetic brake type. 0.33 A for **EZSM3, EZSM4, EASM4** and **EACM4**.

General Specifications

		Built-in Controller Type Pulse Input Type with RS-485 Communication EtherNet/IP Compatible EtherCAT Drive Profile Compatible PROFINET Compatible	Pulse Input Type
Insulation Resistance		100 MΩ or more when a 500 VDC megger is applied between the following places: <ul style="list-style-type: none"> • Protective Earth Terminal – Main Power Supply Terminal • Encoder Connector – Main Power Supply Terminal • I/O Signal Terminal – Main Power Supply Terminal 	
Dielectric Strength		Sufficient to withstand the following for 1 minute: <ul style="list-style-type: none"> • Protective Earth Terminal – Main Power Supply Terminal 1.5 kVAC, 50Hz or 60Hz • Encoder Connector – Main Power Supply Terminal 1.8 kVAC, 50Hz or 60Hz • I/O Signal Terminal – Main Power Supply Terminal 1.8 kVAC, 50Hz or 60Hz 	
Operating Environment (In operation)	Ambient Temperature	0 to +55°C (Non-freezing)*	
	Ambient Humidity	85% or less (Non-condensing)	
	Atmosphere	No corrosive gases or dust. The product should not be exposed to water or oil.	
Degree of Protection		IP10	IP20

* When installing a motor to a heat sink of a capacity at least equivalent to an aluminum plate of 200×200 mm, thickness 2 mm.

Note

- Disconnect the motor and driver when taking an insulation resistance measurement or performing a dielectric voltage withstand test. Also, do not perform these tests on the absolute sensor part of the motor.

The drivers and cables to be combined with the actuators are the same as the **αSTEP AZ Series**.

αSTEP AZ Series Brochure is available. When selecting products, please also use the brochure.



DC Input

Product Number

AZD - K D

① ② ③

①	Driver Type	AZD: AZ Series Driver
②	Power Supply Input	K: 24 VDC/48 VDC
③	Type	D: Built-in Controller Type X: Pulse Input Type with RS-485 Communication Blank: Pulse Input Type EP: EtherNet/IP Compatible ED: EtherCAT Drive Profile Compatible PN: PROFINET Compatible

Product Line

Driver

◇ Built-in Controller Type



Power Supply Input	Product Name	List Price
24/48 VDC	AZD-KD	396.00 €

◇ Pulse Input Type with RS-485 Communication



Power Supply Input	Product Name	List Price
24/48 VDC	AZD-KX	396.00 €

◇ Pulse Input Type



Power Supply Input	Product Name	List Price
24/48 VDC	AZD-K	341.00 €

◇ EtherNet/IP Compatible Type



Power Supply Input	Product Name	List Price
24/48 VDC	AZD-KEP	440.00 €

◇ EtherCAT Drive Profile Compatible Type



Power Supply Input	Product Name	List Price
24/48 VDC	AZD-KED	440.00 €

◇ PROFINET Compatible Type



Power Supply Input	Product Name	List Price
24/48 VDC	AZD-KPN	440.00 €

Included

Type	Included	Connector
Built-In Controller Type Pulse Input Type with RS-485 Communication Pulse Input Type		CN1 Connector (1 pc.) CN4 Connector (1 pc.)
EtherNet/IP Compatible EtherCAT Drive Profile Compatible PROFINET Compatible		CN1 Connector (1 pc.) CN4 Connector (1 pc.) CN7 Connector (1 pc.)

Driver Specifications

Driver Product Name		AZD-KD	AZD-KX AZD-K	AZD-KEP AZD-KED AZD-KPN
Main Power Supply	Input Voltage	EASM2, EACM2	24 VDC ± 5%	
		EZSM3, EZSM4, EZSM6, EASM4, EASM6, EACM4, EACM6	· 24 VDC ± 5%*1 · 48 VDC ± 5%	· 24 VDC ± 5% · 48 VDC ± 5%
	Input Current	EASM2, EACM2	1.6 A	1.6 A
		EZSM3, EZSM4, EASM4, EACM4	1.72 A (1.8 A)*2	1.5 A
		EZSM6, EASM6, EACM6	3.55 A (3.8 A)*2	3.3 A
Control Power Supply	Input Voltage		–	24 VDC ± 5%*1
	Input Current		–	0.15 A (0.4 A)*3

*1 If the electromagnetic brake type is extended 20 m with a cable, the specification becomes 24 VDC ± 4%.

*2 The parentheses () indicate the specifications for the electromagnetic brake type.

*3 The parentheses () indicate the specifications for the electromagnetic brake type. 0.23 A for **EZSM3, EZSM4, EASM4** and **EACM4**.

General Specifications

Common to all drivers

Insulation Resistance	100 MΩ or more when a 500 VDC megger is applied between the following places: · Protective Earth Terminal – Power Supply Terminal	
Dielectric Strength	–	
Operating Environment (In operation)	Ambient Temperature	0 to +50°C (Non-freezing)
	Ambient Humidity	85% or less (Non-condensing)
	Atmosphere	No corrosive gases or dust. The product should not be exposed to water or oil.
Degree of Protection	IP10	

Note

- Disconnect the motor and driver when taking an insulation resistance measurement or performing a dielectric voltage withstand test. Also, do not perform these tests on the absolute sensor part of the motor.

Electric Linear Slides

αSTEP AZ Series Equipped **EZS**

αSTEP AZ Series Equipped **EAS**

Electric Cylinders

αSTEP AZ Series Equipped **EAC**

Driver/Connection cable

Peripheral Equipment

The drivers and cables to be combined with the actuators are the same as the **αSTEP AZ Series**.

αSTEP AZ Series Brochure is available. When selecting products, please also use the brochure.



Cables (Common to all series)

The motor cable and electromagnetic brake cable from the motor cannot be connected directly to the driver.
When connecting to a driver, use a connection cable.
Use the flexible connection cable in applications where the cable is bent and flexed repeatedly.

AC Input

Product Number

CC 050 V Z F B

① ② ③ ④ ⑤ ⑥

①	CC: Cable
②	Length 005: 0.5 m 010: 1 m 015: 1.5 m 020: 2 m 025: 2.5 m 030: 3 m 040: 4 m 050: 5 m 070: 7 m 100: 10 m 150: 15 m 200: 20 m
③	Reference Number
④	Applicable Model Z: AZ Series
⑤	Cable Type F: Connection Cable Set R: Flexible Connection Cable Set
⑥	Electromagnetic Brake Blank: without Electromagnetic Brake B: with Electromagnetic Brake

Product Line

● For motor / Encoder

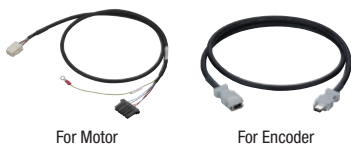

Product Line	Length L [m]	Product Name	List Price
Connection Cable Sets	CC005VZF	0.5	34.00 €
	CC010VZF	1	34.00 €
	CC015VZF	1.5	38.00 €
	CC020VZF	2	44.00 €
	CC025VZF	2.5	49.00 €
	CC030VZF	3	55.00 €
	CC040VZF	4	82.00 €
	CC050VZF	5	92.00 €
	CC070VZF	7	114.00 €
	CC100VZF	10	149.00 €
	CC150VZF	15	206.00 €
	CC200VZF	20	261.00 €
Flexible Connection Cable Sets	CC005VZR	0.5	72.00 €
	CC010VZR	1	72.00 €
	CC015VZR	1.5	77.00 €
	CC020VZR	2	83.00 €
	CC025VZR	2.5	88.00 €
	CC030VZR	3	93.00 €
	CC040VZR	4	107.00 €
	CC050VZR	5	119.00 €
	CC070VZR	7	151.00 €
	CC100VZR	10	200.00 €
	CC150VZR	15	289.00 €
	CC200VZR	20	359.00 €

● For Motor / Encoder / Electromagnetic Brake



Product Line	Length L [m]	Product Name	List Price
Connection Cable Sets	CC005VZFB	0.5	46.00 €
	CC010VZFB	1	46.00 €
	CC015VZFB	1.5	52.00 €
	CC020VZFB	2	59.00 €
	CC025VZFB	2.5	65.00 €
	CC030VZFB	3	71.00 €
	CC040VZFB	4	102.00 €
	CC050VZFB	5	113.00 €
	CC070VZFB	7	140.00 €
	CC100VZFB	10	180.00 €
	CC150VZFB	15	248.00 €
	CC200VZFB	20	314.00 €
Flexible Connection Cable Sets	CC005VZRB	0.5	95.00 €
	CC010VZRB	1	95.00 €
	CC015VZRB	1.5	105.00 €
	CC020VZRB	2	114.00 €
	CC025VZRB	2.5	119.00 €
	CC030VZRB	3	127.00 €
	CC040VZRB	4	143.00 €
	CC050VZRB	5	161.00 €
	CC070VZRB	7	203.00 €
	CC100VZRB	10	261.00 €
	CC150VZRB	15	365.00 €
	CC200VZRB	20	465.00 €

Included

Type	Included	Operating Manual
Connection Cable	—	—
Flexible Connection Cable	—	1 Copy

DC Input

Product Number

CC 050 V Z F B 2

① ② ③ ④ ⑤ ⑥ ⑦ ⑧

①	CC: Cable
②	Length 005: 0.5 m 010: 1 m 015: 1.5 m 020: 2 m 025: 2.5 m 030: 3 m 040: 4 m 050: 5 m 070: 7 m 100: 10 m 150: 15 m 200: 20 m
③	Reference Number
④	Applicable Product Z: AZ Series
⑤	Reference Number Blank: EZSM3, EZSM4, EZSM6, EASM4, EASM6, EACM4, EACM6 2: EASM2, EACM2
⑥	Cable Type F: Connection Cable Set R: Flexible Connection Cable Set
⑦	Description Blank: Without Electromagnetic Brake B: Electromagnetic Brake Type
⑧	Cable Specifications 2: DC Input

Product Line

For **EASM2** and **EACM2**

● For Motor / Encoder



Product Line	Length L [m]	Product Name	List Price
Connection Cable Sets		CC005VZ2F2	0.5 32.00 €
		CC010VZ2F2	1 32.00 €
		CC015VZ2F2	1.5 36.00 €
		CC020VZ2F2	2 42.00 €
		CC025VZ2F2	2.5 47.00 €
		CC030VZ2F2	3 53.00 €
		CC040VZ2F2	4 82.00 €
		CC050VZ2F2	5 92.00 €
		CC070VZ2F2	7 114.00 €
		CC100VZ2F2	10 149.00 €
		CC150VZ2F2	15 206.00 €
	CC200VZ2F2	20 261.00 €	
Flexible Connection Cable Sets		CC005VZ2R2	0.5 72.00 €
		CC010VZ2R2	1 72.00 €
		CC015VZ2R2	1.5 77.00 €
		CC020VZ2R2	2 83.00 €
		CC025VZ2R2	2.5 89.00 €
		CC030VZ2R2	3 77.00 €
		CC040VZ2R2	4 107.00 €
		CC050VZ2R2	5 119.00 €
		CC070VZ2R2	7 152.00 €
		CC100VZ2R2	10 200.00 €
		CC150VZ2R2	15 280.00 €
	CC200VZ2R2	20 359.00 €	

Electric Linear Slides

QSTEP AZ Series Equipped **EZS**

QSTEP AZ Series Equipped **EAS**

Electric Cylinders

QSTEP AZ Series Equipped **EAC**

Driver/Connection cable

Peripheral Equipment

For EASM4, EASM6, EZSM3, EZSM4, EZSM6, EACM4 and EACM6

● For Motor / Encoder



For Motor

For Encoder

Product Line	Length L [m]	Product Name	List Price
Connection Cable Sets	0.5	CC005VZF2	32.00 €
	1	CC010VZF2	32.00 €
	1.5	CC015VZF2	36.00 €
	2	CC020VZF2	42.00 €
	2.5	CC025VZF2	47.00 €
	3	CC030VZF2	53.00 €
	4	CC040VZF2	82.00 €
	5	CC050VZF2	92.00 €
	7	CC070VZF2	114.00 €
	10	CC100VZF2	149.00 €
	15	CC150VZF2	206.00 €
Flexible Connection Cable Sets	0.5	CC005VZR2	72.00 €
	1	CC010VZR2	72.00 €
	1.5	CC015VZR2	77.00 €
	2	CC020VZR2	83.00 €
	2.5	CC025VZR2	88.00 €
	3	CC030VZR2	93.00 €
	4	CC040VZR2	107.00 €
	5	CC050VZR2	119.00 €
	7	CC070VZR2	151.00 €
	10	CC100VZR2	200.00 €
	15	CC150VZR2	289.00 €
20	CC200VZR2	359.00 €	

● For Motor / Encoder / Electromagnetic Brake



For Motor

For Encoder

For Electromagnetic Brake

Product Line	Length L [m]	Product Name	List Price
Connection Cable Sets	0.5	CC005VZFB2	44.00 €
	1	CC010VZFB2	44.00 €
	1.5	CC015VZFB2	50.00 €
	2	CC020VZFB2	57.00 €
	2.5	CC025VZFB2	63.00 €
	3	CC030VZFB2	69.00 €
	4	CC040VZFB2	102.00 €
	5	CC050VZFB2	113.00 €
	7	CC070VZFB2	140.00 €
	10	CC100VZFB2	180.00 €
	15	CC150VZFB2	248.00 €
Flexible Connection Cable Sets	0.5	CC005VZRB2	95.00 €
	1	CC010VZRB2	95.00 €
	1.5	CC015VZRB2	105.00 €
	2	CC020VZRB2	114.00 €
	2.5	CC025VZRB2	119.00 €
	3	CC030VZRB2	127.00 €
	4	CC040VZRB2	143.00 €
	5	CC050VZRB2	161.00 €
	7	CC070VZRB2	203.00 €
	10	CC100VZRB2	261.00 €
	15	CC150VZRB2	365.00 €
20	CC200VZRB2	465.00 €	

Included

Included	Included	Operating Manual
Connection Cable	—	—
Flexible Connection Cable	1 Copy	—

Note on Use of Cables

Notes on Connecting Connectors

Be sure to hold the connector when connecting or disconnecting the connector.

Connecting or disconnecting the connector while holding the cable may cause poor connection.

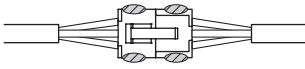

Location for holding connectors

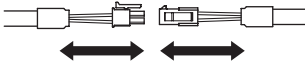

When Inserting Connector

Hold the connector main body and insert it firmly and straight. Inserting the connector in an inclined state may cause damage to the terminals or a connection failure.

When Pulling Out Connector

Pull the connector straight out while releasing the lock part of the connector.

Pulling out while holding the cable may cause damage to the connector.

Note on Wiring of Flexible Cables

Do not bend the cable at the connector part. Stress is applied to the connector and terminals, resulting in poor contact or disconnection.

How to Fix Cable

Fix the connector at two positions so that it does not move.

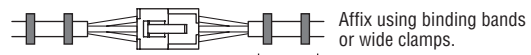

Affix using binding bands or wide clamps.

Wide clamp also acceptable

Cable Length and Bending Radius

Select an appropriate cable length so that the cable is not under tension even when it is moved.

Bending radius (R) should be at least 6 times of the cable diameter.



Contact between Cables

When wiring in the cable holder, make sure to prevent contact between cables. Stress is applied to the cable, resulting in early disconnection. Carefully check the precautions for the cable holder before use.

Twisted Cable

Wire the cables so that they are not twisted. Bending in a twisted state may cause early disconnection.

After wiring, check that the cable is not twisted, referring to the printing on the cable surface, etc.

Peripheral Equipment

Dual-Axis Mounting Brackets (For EZS Series)

Dedicated mounting brackets for using two axes of the **EZS** Series electric linear slide straight type.

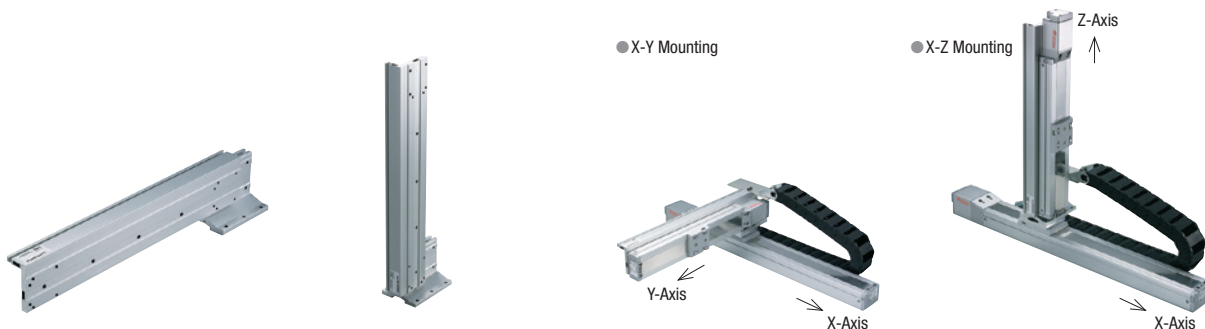

Features

- Two axes of the **EZS** Series can easily be used in combination

Using the dedicated mounting brackets allows you to use two **EZS** Series electric linear slides in a biaxial configuration. Various combinations are available such as X-Y or X-Z.

Available Combinations

X-Y Mounting

X-Axis	Y-Axis	Transportable Mass [kg]
EZSM4-D	EZSM3-D	2.3 or less
EZSM6-D	EZSM3-D	5.7 or less
EZSM6-D	EZSM4-D	12.7 or less

X-Z Mounting

X-Axis	Z-Axis	Transportable Mass [kg]
EZSM4-D	EZSM3-D	3.5 or less
EZSM6-D	EZSM3-D	3.5 or less
EZSM6-D	EZSM4-D	6.7 or less

- Only straight type can be assembled.
- The maximum length of a linear slide for the second axis (Y and Z) is 300 mm.
- This is applicable to products with 12 mm in lead screw pitch (**D**). Speed is reduced by half for products with 6 mm in lead screw pitch (**E**).
- Specification values are based on those when the X-axis is mounted horizontally.
- This product is not compatible with use in the clean room environment.

- Simple Streamlined Wiring with Dedicated Cable Holder (Cable holder sold separately)

Dedicated cable holders are available.



Product Number

PAB - S4 S3 R 005

- ① ② ③ ④ ⑤

①	Dual-Axis Mounting Bracket	
②	First Axis Linear Slide	S4: EZSM4-D S6: EZSM6-D
③	Second Axis Linear Slide	S3: EZSM3-D S4: EZSM4-D
④	Combination Patterns	R: R-Type L: L-Type
⑤	Stroke in Second Axis	

● First axis refers to X-axis, while second axis refers to Y- or Z-axis.

Product Line

50 mm Increment

Combination of EZSM4 and EZSM3		Combination of EZSM6 and EZSM3		Combination of EZSM6 and EZSM4		List Price
R-Type	L-Type	R-Type	L-Type	R-Type	L-Type	
PAB-S4S3R005	PAB-S4S3L005	PAB-S6S3R005	PAB-S6S3L005	PAB-S6S4R005	PAB-S6S4L005	198.00 €
PAB-S4S3R010	PAB-S4S3L010	PAB-S6S3R010	PAB-S6S3L010	PAB-S6S4R010	PAB-S6S4L010	203.00 €
PAB-S4S3R015	PAB-S4S3L015	PAB-S6S3R015	PAB-S6S3L015	PAB-S6S4R015	PAB-S6S4L015	208.00 €
PAB-S4S3R020	PAB-S4S3L020	PAB-S6S3R020	PAB-S6S3L020	PAB-S6S4R020	PAB-S6S4L020	213.00 €
PAB-S4S3R025	PAB-S4S3L025	PAB-S6S3R025	PAB-S6S3L025	PAB-S6S4R025	PAB-S6S4L025	218.00 €
PAB-S4S3R030	PAB-S4S3L030	PAB-S6S3R030	PAB-S6S3L030	PAB-S6S4R030	PAB-S6S4L030	223.00 €

Cable Holders (For EZS Series)

These cable holders protect and guide cables in dual or three axes combinations. They can be combined with the dual-axis mounting brackets.

Product Line

Applicable Products		Applicable Cable Holder	
Applicable Products	Stroke [mm]	Product Name	List Price
EZS Series	50 to 70	PACH65-11	102.00 €
	80 to 120	PACH65-13	110.00 €
	130 to 170	PACH65-14	114.00 €
	180 to 220	PACH65-15	118.00 €
	230 to 270	PACH65-17	126.00 €
	280 to 320	PACH65-18	130.00 €
	330 to 370	PACH65-20	138.00 €
	380 to 420	PACH65-21	142.00 €
	430 to 470	PACH65-22	146.00 €
	480 to 520	PACH65-24	154.00 €
	530 to 570	PACH65-25	158.00 €
	580 to 620	PACH65-27	166.00 €
	630 to 670	PACH65-28	170.00 €
	680 to 720	PACH65-29	174.00 €
730 to 770	PACH65-31	182.00 €	
780 to 820	PACH65-32	186.00 €	
830 to 850	PACH65-34	194.00 €	



Dimensions (Unit: mm)

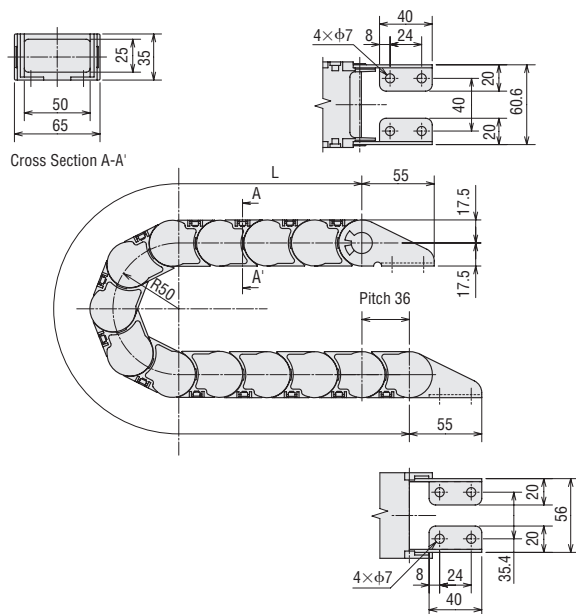

Product Name	L [mm]
PACH65-11	396
PACH65-13	468
PACH65-14	504
PACH65-15	540
PACH65-17	612
PACH65-18	648
PACH65-20	720
PACH65-21	756
PACH65-22	792
PACH65-24	864
PACH65-25	900
PACH65-27	972
PACH65-28	1008
PACH65-29	1044
PACH65-31	1116
PACH65-32	1152
PACH65-34	1224

(L represents the total length of the dimensions.)

Electric
Linear
Slides

QSTEP
AZ Series
Equipped
EZS

QSTEP
AZ Series
Equipped
EAS

Electric
Cylinders

QSTEP
AZ Series
Equipped
EAC

Driver/
Connection
cable

Peripheral
Equipment

Sensor Sets (For EZS Series)

The sensor sets dedicated to the **EZS** Series consist of three sensors, three sensor mounting brackets, and three flexible sensor cables with connector (2 m) and one shielding plate.

The screws needed for installation are also included.

Product Line

Product Name	Applicable Product	Sensor Output	List Price
PAES-S	EZS Series	NPN	150.00 €
PAES-SY		PNP	

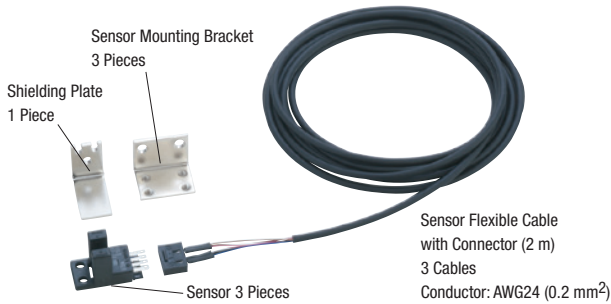

Specifications

NPN Type

Item	Model: EE-SX674A (OMRON)
Power Supply Voltage	5 to 24 VDC $\pm 10\%$, ripple (P-P) 10% or less
Current Consumption	35 mA or less
Control Output	NPN Open-collector output, 5 to 24 VDC, 100 mA or less Residual voltage 0.8 VDC or less (at load current of 100 mA)
Sensor Logic	Normally open/Normally closed (Switchable, depending on connection)
Indicator LED	Detection display (Red)

PNP Type

Item	Model: EE-SX674R (OMRON)
Power Supply Voltage	5 to 24 VDC $\pm 10\%$, ripple (P-P) 10% or less
Current Consumption	30 mA or less
Control Output	PNP Open-collector output, 5 to 24 VDC, 50 mA or less Residual voltage 1.3 VDC or less (at load current of 50 mA)
Sensor Logic	Normally open/Normally closed (Switchable, depending on connection)
Indicator LED	Detection display (Red)

Dimensions of Recommended Sensor Installation Positions (Unit: mm)

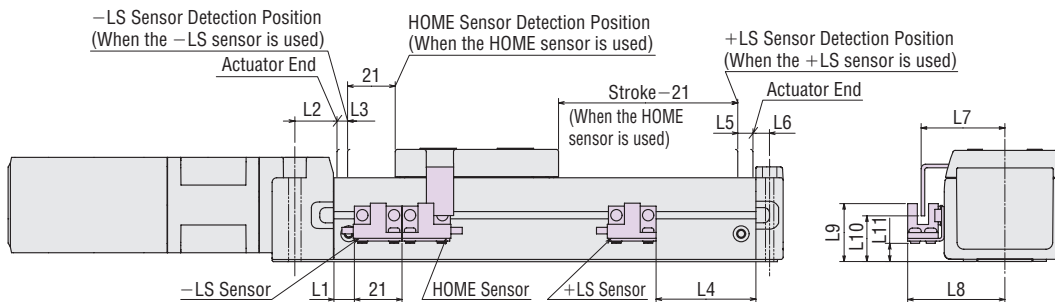

Linear Slide Model	L1	L2	L3	L4	L5	L6	L7	L8	L9	L10	L11
EZSM3	9	18	5	44	6	7.5	37.3	43.3	25.8	20.4	8.1
EZSM4	9	18	5	44	6	7.5	47.3	53.3	25.8	20.4	8.1
EZSM6	13.5	34	7	87.5	8	13.5	47.3	53.3	42.3	36.9	24.6

Note

● If the stroke is 60 mm or less, all three sensors cannot be installed.

Sensor Sets (For EAS Series)

The sensor sets consist of three sensors, three sensor mounting brackets and three flexible sensor cables with connector (2 m) and one shielding plate.

The screws needed for installation are also included.

The product name differs depending on the table type, electric linear slide model number, and sensor output.

Product Line

For X-Table Type

Product Name	Applicable Product	Sensor Output	List Price
PAES-S-2X	EASM2	NPN	108.00 €
PAES-SY-2X		PNP	
PAES-S-4X	EASM4	NPN	
PAES-SY-4X		PNP	
PAES-S-6X	EASM6	NPN	
PAES-SY-6X		PNP	

For Y-Table Type

Product Name	Applicable Product	Sensor Output	List Price
PAES-S-2Y	EASM2	NPN	108.00 €
PAES-SY-2Y		PNP	
PAES-S-4Y	EASM4	NPN	
PAES-SY-4Y		PNP	
PAES-S-6Y	EASM6	NPN	
PAES-SY-6Y		PNP	



Specifications

NPN Type

Item	Model: EE-SX674A (OMRON)
Power Supply Voltage	5 to 24 VDC \pm 10%, ripple (P-P) 10% or less
Current Consumption	35 mA or less
Control Output	NPN Open-collector output, 5 to 24 VDC, 100 mA or less Residual voltage 0.8 VDC or less (at load current of 100 mA)
Sensor Logic	Normally open/Normally closed (Switchable, depending on connection)
Indicator LED	Detection display (Red)

PNP Type

Item	Model: EE-SX674R (OMRON)
Power Supply Voltage	5 to 24 VDC \pm 10%, ripple (P-P) 10% or less
Current Consumption	30 mA or less
Control Output	PNP Open-collector output, 5 to 24 VDC, 50 mA or less Residual voltage 1.3 VDC or less (at load current of 50 mA)
Sensor Logic	Normally open/Normally closed (Switchable, depending on connection)
Indicator LED	Detection display (Red)

Dimensions of Recommended Sensor Installation Positions (Unit: mm)

The dimensions below is an example of the X-table type of **EASM4**. The same applies to the Y-table type.

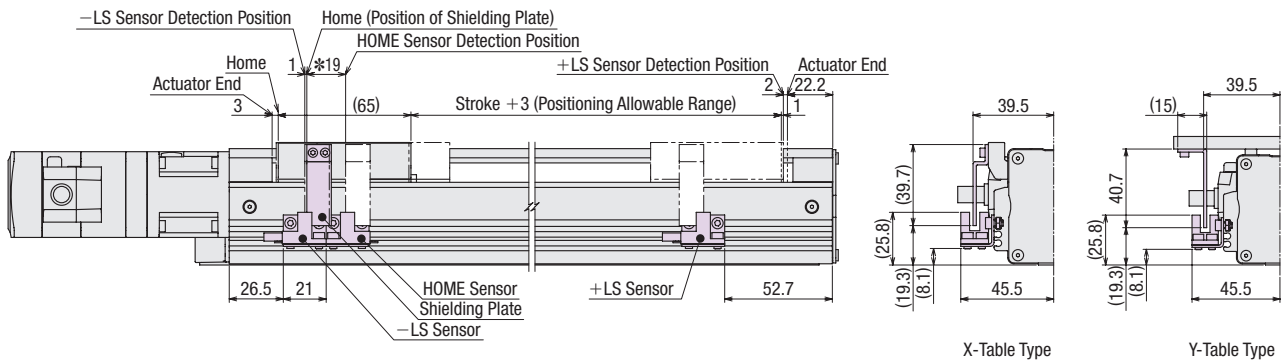

*This is an example for when the position offset of home-seeking is set to -19 mm in return-to-home operation of the 3-sensor mode.

● For a dimensions of the sensor installation position of other models, refer to the operating manual "Sensor set" or Oriental Motor website.

Electric Linear Slides

QSTEP AZ Series Equipped EZS

QSTEP AZ Series Equipped EAS

Electric Cylinders

QSTEP AZ Series Equipped EAC

Driver/Connection cable

Peripheral Equipment

Installation of Shielding Plate

X-Table Type

For the X-table type, the shielding plate can be attached to the linear slide table. Attach the shielding plate that comes with the sensor set to the screw holes on the side of the table.

With the **EASM4** and **EASM6** with sensor rails, the sensor set cable can be stored inside the sensor rails.

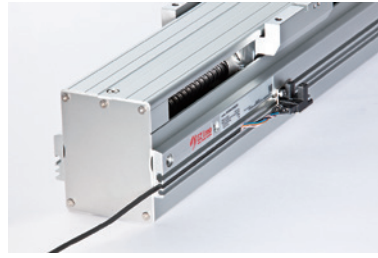
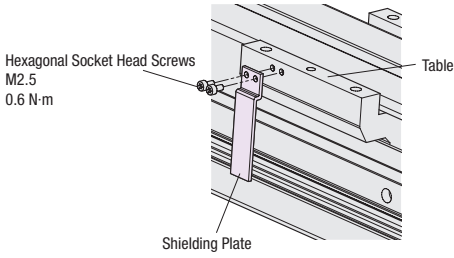

Installation of Sensor Set (**EASM4, EASM6**)



Installation of Sensor Set (**EASM2**)

Y-Table Type

For the Y-table type, attach the shielding plate to the customer's work. It is necessary to process the screw holes that attach the shielding plate to the customer's work.

For the positions of the screw holes for mounting the shielding plate, refer to the dimensions of recommended shielding plate mounting hole position.

The shielding plate must be installed so that it does not interfere with the sensor. The dimensions of the shielding plate for Y-table type is shown below. Check that the sensor and the shielding plate do not interfere with each other. If the accessory shielding plate cannot be used, please prepare the shielding plate yourself.

◇ Dimensions of Recommended Shielding Plate Mounting Hole Position (Unit: mm)

EASM2

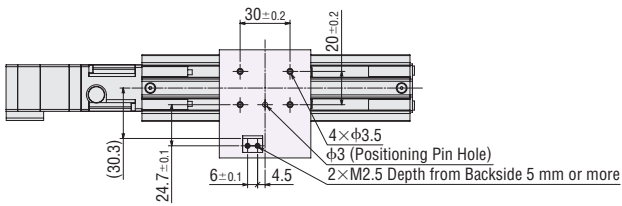

EASM4

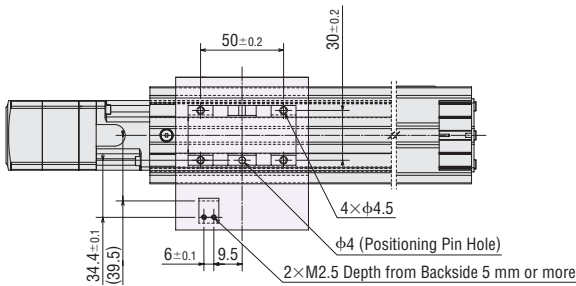

EASM6

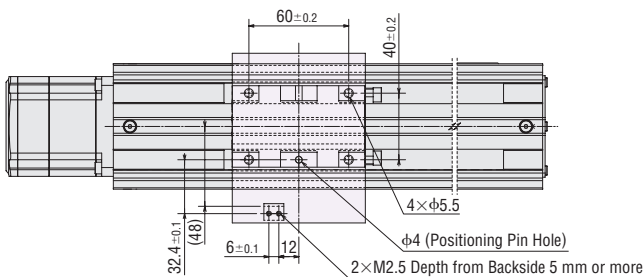

◇ Shielding Plate Dimensions (Unit: mm)

EASM2

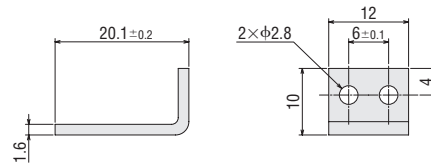

EASM4

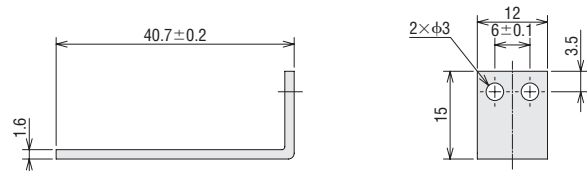

EASM6

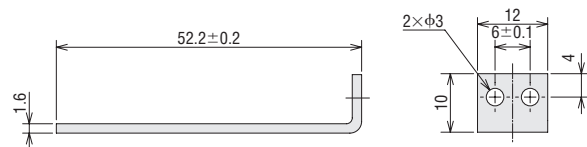

Orientalmotor

These products are manufactured at plants certified with the international standards **ISO 9001** (for quality assurance) and **ISO 14001** for systems of environmental management).

Specifications are subject to change without notice. Published in October 2023.

ORIENTAL MOTOR (EUROPA) GmbH

European Headquarters

Schiessstraße 44
40549 Düsseldorf, Germany
Tel: 0211 5206700 Fax: 0211 52067099

Spanish Office

C/Caléndula 93 - Ed. E - Miniparc III
28109 El Soto de La Moraleja,
Alcobendas (Madrid), Spain
Tel: +34 918 266 565

ORIENTAL MOTOR (UK) LTD.

UK Headquarters

Unit 5, Faraday Office Park,
Rankine Road, Basingstoke,
Hampshire RG24 8AH, U.K.
Tel: +44 1256 347090 Fax: +44 1256 347099

ORIENTAL MOTOR SWITZERLAND AG

Switzerland Headquarters

Badenerstrasse 13
5200 Brugg AG, Switzerland
Tel: +41 56 560 50 45 Fax: +41 56 560 50 47

ORIENTAL MOTOR ITALIA s.r.l.

Italy Headquarters

Via XXV Aprile 5
20016 Pero (MI), Italy
Tel: +39 2 93906346 Fax: +39 2 93906348

ORIENTAL MOTOR (FRANCE) SARL

France Headquarters

56, Rue des Hautes Pâtures
92000 Nanterre, France
Tel: +33 1 47 86 97 50 Fax: +33 1 47 82 45 16

Customer Service Center

(Support in German & English)

00800 22 55 66 22*

Mon - Thu: 08:00 - 16:30 CET

Friday: 08:00 - 15:00 CET

*Free Call Europe

info@orientalmotor.de

WWW.ORIENTALMOTOR.EU

EN | DE | UK | IT | FR | ES